



Panther Pro

OUTILLAGE POUR LES PROFESSIONNELS



TOPTUL®



VITRAGE AUTOMOBILE



DÉCOUPE



OUTILLAGE À MAIN



MÉCANIQUE AUTOMOBILE



ÉCLAIRAGE & ÉLECTRICITÉ



CARROSSERIE AUTOMOBILE



CONSOMMABLES & SÉCURITÉ

CATALOGUE 2019

SOMMAIRE

P3-180

TOPTUL / PROFESSIONAL HANDTOOLS

P181-221

VITRAGE AUTOMOBILE / REMPLACEMENT & RÉPARATION

P222-226

DÉCOUPE / COUTEAUX, SCIES, LAMES, CUTTERS, CISAILLES, ...

P227-239

OUTILLAGE À MAIN / TOURNEVIS, CLÉS, PINCES, ...

P240-250

MÉCANIQUE AUTOMOBILE / OUTILLAGE PNEUMATIQUE, CAISSE À OUTILS, ...

P251-254

ÉCLAIRAGE & ÉLECTRICITÉ / BALADEUSES, CÂBLES, FUSIBLES, ...

P255-260

CARROSSERIE AUTOMOBILE / ABRASIFS, PONCEUSES, ...

P261-280

CONSOMMABLES & SÉCURITÉ / LUNETTES, HOUSSES, GANTS, ...

P281

BON DE COMMANDE

Tous les prix de ce catalogue s'entendent hors taxes.
Important : à la livraison, les prix peuvent faire l'objet de modifications en fonction de l'évolution de différents paramètres (matière, main-d'œuvre, taux de change...)



TOPTUL®

THE MARK OF PROFESSIONAL TOOLS



TOPTUL®

www.toptul.co.uk

TOPTUL® PRODUCT WARRANTY

The Majority of **TOPTUL®** Professional Tools, are guaranteed against any defects in materials and workmanship for the life of the tool. We will repair or replace any tool that fails to give satisfactory service, on the condition that the tool has not been abused, misused or modified in any way and that it is returned to an authorized TOPTUL distributor for inspection and analysis.

COMMON PROBLEMS THAT ARE NOT COVERED BY TOPTUL WARRANTY

- Misuse & Abusing TOPTUL products:**
For instance, misusing screwdrivers as chisels, punches or pry bars, hitting wrenches with a hammer to increase driving force. The bad worn products are resulted from misuse and abuse.
- Altered TOPTUL products:**
For instance, grinding or filing of products to change the dimensions in any way will void any warranty terms available.
- Improper External Force placed on TOPTUL products:**
For instance, adding an additional steel pipe / bar to extend and increase leverage on wrenches, ratchets or power / breaker bars will void any warranty terms
- The use of standard sockets with Air impact tools or Power tools:**
For Instance, Impact wrench or air ratchet use with standard sockets will void any warranty terms available on standard CRV sockets. Screwdriver Bits & Bit Sockets are not covered by the TOPUL Warranty.

A GLOBAL BRAND IN THE PROFESSIONAL HAND TOOL INDUSTRY

The **TOPTUL** brand offers a comprehensive range of high performance and superior quality tools to meet the demands of today's professional users.

The brand is manufactured to **TOPTUL** own design and quality Specifications over and above the international standards set by DIN and ANSI.

WARNING & SAFETY RECOMMENDATION

Service.Technology.Quality

- Do Not Use Screwdrivers At Any Angle Other Than Vertical To The Screw / Fastener
- Do Not Open Multiple Drawers At A Time
- Do Not Use Screwdrivers As Pry Bars, Levers, Punches Or Chisels
- Do Not Use Pliers To Hammer/Strike The Bolts And Nuts
- Always Ensure Sockets Are Fully Engaged Before Using A Ratchet
- Do Not Use Pliers To Tighten Or Loosen The Bolts And Nuts
- Read Manufacturers Instructions Before Using Any Tools
- Use Safety Goggles When Required

Square Drive

- 1/4" (6.35mm) 1/4" Drive
- 3/8" (9.5mm) 3/8" Drive
- 1/2" (12.7mm) 1/2" Drive
- 3/4" (19.0mm) 3/4" Drive
- 1" (25.4mm) 1" Drive

Certified Safety & Quality



VDE TESTED, VOLTAGE WITH STAND STRENGTH UP TO 1000 VOLT



GS-TUV QUALITY



CONFORMITE EUROPE



Material

- CR-V Chrome Vanadium Alloy Steel
- CR-MO Chrome Molybdenum Alloy Steel
- SNCM+V Nickel Chrome Molybdenum Alloy Steel
- S2 High Speed Tool Steel
- CR-V+S2 Chrome Vanadium Alloy Steel + High Speed Tool Steel
- SUS Stainless Steel

CONTENTS



Master Tool Sets

Professional mechanical tool sets and modules with mobile trolley and cabinets.



Wrenches & Torque Wrenches

Assortment of super-torque wrenches supplied in both metric and imperial (AF) sizes.



Hand Sockets, Bit Sockets & Accessories

Full range of flank sockets with maxi-drive. Available in 1/4", 3/8", 1/2", 3/4" & 1".



Socket Sets & General Tool Sets

Socket Sets in 3/8", 1/2", 3/4" & 1" and general tool sets.



Impact Sockets, Bit Sockets, Accessories & Air Wrench

Specialised impact tools for automotive and industrial maintenance and repairs. Sizes in 3/8", 1/2", 3/4" & 1".



Hexagon & Star Keys

Practical allen and star key wrench types and sets for the appropriate fasteners.



Screwdrivers, Bits & Power Bits

Conventional and 'Go-Thru' screwdrivers with tips for Phillips, Slotted, Pozidriv, Star & Star Tamperproof types.



Pliers

Exceptional multi-purpose cutting and gripping tools with various capabilities.



Hammers & Striking Tools

Different types of hammers, chisels and punches for various workshop applications.



Tool Storage & Display

Choice of tool storage systems to enable a build up of bespoke work stations.



Auto Tools

Automotive specialty tools for auto mechanical repairs & maintenance.



Other Tools

Essential mechanical tools including pullers, crimping tools & bolt cutters.



Master Tool Sets

W/3 DRAWER TOOL CHEST + W/7 DRAWER TOOL TROLLEY

Satin Chrome Finished



GENERAL SERIES GREEN

349PCS

8 DRAWER TOOLS

ITEM NO.

GW-07005(W/3)
+ GV-27905(W/7)

8 DRAWER TOOLS



70PCS W/3 DRAWER TOOL CHEST

W/3-Drawer Tool Chest - 70PCS Mechanical Tool Set

	CONTENTS	DESCRIPTION
1 ST	GVC2604	26 15° Offset Hi-Performance Combination Wrench Set
	GVA1017	10 Pro-Series Reversible Ratchet Combination Wrench Set
2 ND	GVC1202	12 75° Offset Double Ring Wrench Set
	GVA1103	11 Double Open Wrench Set
3 RD	GVA0301	3 Pliers Assortment Set
	GVA0405	4 Pliers Assortment Set
	GVA0406	4 Retaining Ring Pliers Set

279PCS W/7 DRAWER TOOL TROLLEY

W/7-Drawer Tool Trolley - 279PCS Mechanical Tool Set

	CONTENTS	DESCRIPTION
1 ST	GVA3002	30 3/8" DR. Socket Set
	GVC3903	39 1/2" DR. Socket Set
2 ND	GVC6101	61 Star Wrench, Socket & Screwdriver Set
	GVA5004	50 1/4" DR. Socket Set
3 RD	GVB2503	25 1/2" DR. Bit Socket Set
	GVB1202	12 Screwdriver Set
4 TH	GVB0904	9 Hammer, Punch & Chisel Set
	GVB0701	7 File Tool Set
5 TH	GVD4602	46 1/2" DR. Torque Wrench & Air Impact Wrench Socket Set

279PCS
W/7 DRAWER TOOL TROLLEY
5 DRAWER TOOLS



1ST DRAWER

GVA3002	GVC3903
---------	---------

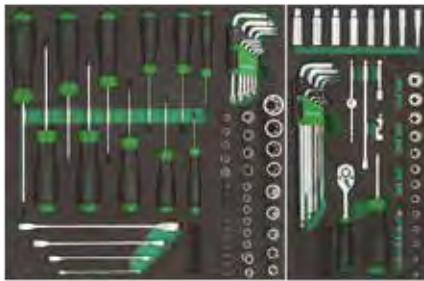

2ND DRAWER

GVC6101	GVA5004
---------	---------



3RD DRAWER

GVB2503	GVB1202
---------	---------



4TH DRAWER

GVB0904	GVB0701
---------	---------



5TH DRAWER

GVD4602

70PCS
W/3 DRAWER TOOL CHEST
3 DRAWER TOOLS

3 DRAWER TOOLS



1ST DRAWER

GVC2604	GVA1017
---------	---------

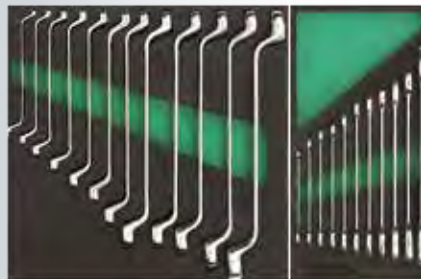

2ND DRAWER

GVC1202	GVA1103
---------	---------



3RD DRAWER

GVA0301	GVA0405	GVA0406
---------	---------	---------



Master Tool Sets

JUMBO

50% MORE SPACE

W/8 DRAWER TOOL TROLLEY



A 360PCS

ITEM NO. **GT-36001**

B 340PCS

ITEM NO. **GT-34001**



GENERAL SERIES
- 8 Drawer Jumbo Roller Cabinet

NEW MECHANICS TOOL SETS

GENERAL SERIES TOOL TROLLEY

- 8 Fully Extendable Jumbo Size Drawers
- Smooth Ball Bearing Slide Drawers with Auto-Return Function
- 10mm EVA Material Top Mat
- Heavy Duty 5"x2" Anti-Slip & Shockproof TPR Casters With Lock (2 Fixed Casters & 2 Swivel Casters with Lock)

A 360PCS

W/8-Drawer Tool Trolley

W/8-Drawer Tool Trolley - 360PCS Mechanical Tool Set

	CONTENTS	DESCRIPTION
1 ST	GTA1541	15 Pro-Series Reversible Ratchet Combination Wrench Set
	GTA0408	4 15° Offset Super-Torque Combination Wrench Set
	GTA1607	16 15° Offset Super-Torque Combination Wrench Set
	GTA0710	7 Double End Swivel-Socket Wrench Set
2 ND	GTA0905	9 Double Open End Wrench Set
	GTA0801	8 75° Offset Double Ring Wrench Set
	GTB7202	72 1/4" DR. Socket & Ball Point Hex Key Wrench Set
	GTB3503	35 3/8" DR. Socket Set
	GTB2504	25 1/2" DR. Flank Socket Set
	GTB2305	23 1/2" DR. Deep Flank Socket Set
3 RD	GTA2234	22 Screw Repair Tools Set
	GTA2414	24 1/2" DR. Bit Socket Set
	GTA1836	18 1/2" DR. Flank Impact Socket Set
	GTA0818	8 Star Tamperproof Screwdriver Set
4 TH	GTC1401	14 Slotted & Phillips Screwdriver Set
	GTA0315	3 Adjustable Wrench & Pliers Set
	GTA0416	4 Pliers Assortment Set
	GTA0427	4 Hammer & Soft Grip Chisel Set
	GTA0532	5 File Set
5 TH	GTA0417	4 Retaining Ring Pliers Set
	GTA1025	10 Soft Grip Chisel & Punch Set
	GTA1031	10 Measuring, Marking & Cutting Tool Set
	GTC0903	9 L-Type Two Way Ball Point & Hex Key Wrench Set
	GTA0333	3 Cutting Tools Set
	GTC0802	8 Hex Nut Driver T-Handle Set

B 340PCS

W/8-Drawer Tool Trolley

W/8-Drawer Tool Trolley - 340PCS Mechanical Tool Set

	CONTENTS	DESCRIPTION
1 ST	GTA1804	18 Double Open End Wrench & Hex Key Wrench Set
	GTA0408	4 15° Offset Super-Torque Combination Wrench Set
	GTA1607	16 15° Offset Super-Torque Combination Wrench Set
	GTA1541	15 Pro-Series Reversible Ratchet Combination Wrench Set
2 ND	GTA0403	4 75° Offset Double Ring Wrench Set
	GTA0801	8 75° Offset Double Ring Wrench Set
	GTA0315	3 Adjustable Wrench & Pliers Set
	GTA0416	4 Pliers Assortment Set
	GTA0710	7 Double End Swivel-Socket Wrench Set
	GTA0724	7 Chisels & Hammers Set
3 RD	GTA0417	4 Retaining Ring Pliers Set
	GTA0611	6 Flare Nut Wrench Set
	GTB7202	72 1/4" DR. Socket & Ball Point Hex Key Wrench Set
	GTB3503	35 3/8" DR. Socket Set
4 TH	GTB2504	25 1/2" DR. Flank Socket Set
	GTB0609	6 Torque Wrench, Adaptor & Ratchet Handle Set
	GTA0230	2 Pipe Wrench & Ball Peen Hammer Set
	GTA1213	12 1/2" DR. Bit Socket Set
	GTA0621	6 Go-Thru Slotted & Phillips Screwdriver Set
5 TH	GTA0532	5 File Set
	GTA0135	6 Hand Riveter Set
	GTA0819	8 Star Screwdriver Set
	GTB4006	40 Star & Tamperproof Socket Wrench Set
	GTB0811	8 L-Type Two Way Ball Point & Hex Key Wrench Set
	GTB0808	8 Hacksaw, Adjustable Wrench & Pin Punch Set
	GTB1107	11 Measuring, Marking & Cutting Tool Set

5 DRAWER TOOLS

A 360PCS

CONTENTS

- 1ST
 - GTA1541
 - GTA0408
 - GTA1607
 - GTA0710
 - GTA0905
 - GTA0801

- 2ND
 - GTB7202
 - GTB3503
 - GTB2504
 - GTB2305

- 3RD
 - GTA2234
 - GTA2414
 - GTA1836
 - GTA0818
 - GTC1401
 - GTA0315
 - GTA0416

- 4TH
 - GTA0427
 - GTA0532
 - GTA0417
 - GTA1025

- 5TH
 - GTA1031
 - GTC0903
 - GTA0333
 - GTC0802

A 360PCS



1ST DRAWER

GTA1541	GTA0710
GTA0408	GTA0905
GTA1607	GTA0801



2ND DRAWER

GTB7202	GTB3503	GTB2504	GTB2305
---------	---------	---------	---------



3RD DRAWER

GTA2234	GTA0818
GTA2414	GTC1401
GTA1836	



4TH DRAWER

GTA0315	GTA0532
GTA0416	GTA0417
GTA0427	GTA1025



5TH DRAWER

GTA1031	GTA0333
GTC0903	GTC0802

B 340PCS



1ST DRAWER

GTA1804	GTA1541
GTA0408	GTA0403
GTA1607	GTA0801



2ND DRAWER

GTA0315	GTA0724
GTA0416	GTA0417
GTA0710	GTA0611



3RD DRAWER

GTB7202	GTB3503	GTB2504	GTB0609
---------	---------	---------	---------



4TH DRAWER

GTA0230	GTA0532
GTA1213	GTA0135
GTA0621	GTA0819



5TH DRAWER

GTB4006	GTB0811	GTB0808	GTB1107
---------	---------	---------	---------

B 340PCS

CONTENTS

- 1ST
 - GTA1804
 - GTA0408
 - GTA1607
 - GTA1541
 - GTA0403
 - GTA0801
 - GTA0315
 - GTA0416

- 2ND
 - GTA0710
 - GTA0724
 - GTA0417
 - GTA0611

- 3RD
 - GTB7202
 - GTB3503
 - GTB2504
 - GTB0609
 - GTA0230
 - GTA1213

- 4TH
 - GTA0621
 - GTA0532
 - GTA0135
 - GTA0819
 - GTB4006

- 5TH
 - GTB0811
 - GTB0808
 - GTB1107

Master Tool Sets

333 PCS W/3-Drawer Tool Chest + W/7-Drawer Tool Trolley

Satin Chrome Finished

Pro-Line Series

- Durable ABS Work Table
- Long-Life Drawers with Ball Bearing Slides
- One Drawer Openable Internal Locking Design
- Anti-Slip & Shockproof 5"x2" TPR Casters



W/3-Drawer Tool Chest - 104PCS Mechanical Tool Set

	CONTENTS	DESCRIPTION
1 ST	GAAT0702	7 Double End Swivel-Socket Wrench Set
	GAAT0502	5 Flare Nut Wrench Set
	GAAT2302	23 Star Socket Wrench Set
2 ND	GAAT1202	12 1/2" Dr. Bit Socket Set
	GCAT1807	18 1/2" Dr. Impact Socket Set
	GBAT0201	2 Ball Peen Hammers & Heavy Duty Pipe Wrench Set
	GAAT0101	5 Hand Riveter Set
	GAAT0807	8 Star Tamperproof Screwdriver Set
3 RD	GCAT0701	7 Chisels & Hammers Set
	GCAT0801	8 Hacksaw, Adjustable Wrench & Pin Punch Set
	GCAT0803	8 Torque Wrench & Ratchet Handle Set

W/7-Drawer Tool Trolley - 229PCS Mechanical Tool Set

	CONTENTS	DESCRIPTION
1 ST	GAAT0402	4 75° Offset Double Ring Wrench Set
	GAAT0802	8 75° Offset Double Ring Wrench Set
	GAAT1802	18 Double Open End Wrench & Hex Key Wrench Set
	GAAT1205	12 Pro-Series Reversible Ratchet Combination Wrench Set
2 ND	GAAT0407	4 15° Offset Super-Torque Combination Wrench Set
	GAAT1002	10 Angled Socket Wrench Set
	GAAT1603	16 15° Offset Super-Torque Combination Wrench Set
3 RD	GCAT1808	18 3/8" Dr. Socket Set
	GCAT2402	24 1/2" Dr. Socket Set
4 TH	GCAT7202	72 1/4" Dr. Socket & Ball Point Hex Key Wrench Set
	GBAT0303	3 Adjustable Wrench & Pliers Set
	GBAT0402	4 Pliers Assortment Set
	GBAT0401	4 Retaining Ring Pliers Set
	GBAT0501	5 File Set
5 TH	GAAT0805	8 Slotted & Phillips Screwdriver Set
	GAAT0811	8 L-Type Key Wrench Set
	GCAT1101	11 Measuring, Marking & Cutting Tool Set

PRO-LINE SERIES

- ITEM NO: **GCAZ0013** (W/3) 3 Drawer Top Chest with Tools
GCAJ0014 (W/7) 7 Drawer Roll Cab with Tools



8 DRAWER TOOLS

(W/3) 104pcs + (W/7) 229pcs

PROFESSIONAL MECHANICAL TOOL SETS

W/3-Drawer Tool Chest 104PCS



1ST DRAWER

GAAT0702	GAAT0502	GAAT2302	GAAT1202
----------	----------	----------	----------



2ND DRAWER

GCAT1807	GBAT0201	GAAT0101	GAAT0807
----------	----------	----------	----------



3RD DRAWER

GCAT0701	GCAT0801
	GCAT0803

PROFESSIONAL MECHANICAL TOOL SETS

W/7-Drawer Tool Trolley 229PCS



1ST DRAWER

GAAT0402	GAAT0802	GAAT1802	GAAT1205
----------	----------	----------	----------



2ND DRAWER

GAAT0407	GAAT1002
	GAAT1603



3RD DRAWER

GCAT1808	GCAT2402
	GCAT7202



4TH DRAWER

GBAT0303	GBAT0402	GBAT0401	GBAT0501
----------	----------	----------	----------



5TH DRAWER

GAAT0805	GAAT0811
	GCAT1101



PRO-LINE SERIES



Smart Folderable Key



New-Style Plastic Drawer Handle



Heavy Duty 5"x2" Anti-Slip & Shockproof TPR Casters with Lock

Master Tool Sets

305PCS W/7-Drawer Tool Trolley

5 DRAWER TOOLS

Satin Chrome Finished



ITEM NO. **GCAJ305G**



ITEM NO. **GCAJ305N**

W/7-Drawer Tool Trolley - 305PCS Mechanical Tool Set

	CONTENTS	DESCRIPTION
1 ST	GAAT1301	13 15° Offset Hi-Performance Combination Wrench Set
	GAAT0817	8 Pro-Series Ratchet Combination Wrench Set
	GAAT1802	18 Double Open End Wrench & Hex Key Wrench Set
	GAAT0802	8 75° Offset Double Ring Wrench Set
2 ND	GCAT2001	20 3/8" Dr. Socket Set
	GCAT2507	25 1/2" Dr. Socket Set
	GCAT7202	72 1/4" Dr. Socket & Ball Point Hex Key Wrench Set
3 RD	GAAT6502	65 Star Socket, Key Wrench & Bit Set
	GCAT1807	18 1/2" Dr. Flank Impact Socket Set
	GAAT0805	8 Slotted & Phillips Screwdriver Set
	GAAT0807	8 Star Tamperproof Screwdriver Set
4 TH	GBAT0303	3 Adjustable Wrench & Pliers Set
	GBAT0402	4 Pliers Assortment Set
	GBAT0401	4 Retaining Ring Pliers Set
	GCAT0701	7 Chisels & Hammers Set
5 TH	GBAT0501	5 File Set
	GAAT0811	8 L-Type Two Way Ball Point & Hex Key Wrench Set
	GCAT1101	11 Measuring, Marking & Cutting Tool Set

1ST DRAWER

GAAT1301	GAAT0817	GAAT1802	GAAT0802
----------	----------	----------	----------



2ND DRAWER

GCAT2001	GCAT2507
	GCAT7202



3RD DRAWER

GAAT6502	GCAT1807	GAAT0805	GAAT0807
----------	----------	----------	----------



4TH DRAWER

GBAT0303	GBAT0402	GBAT0401	GCAT0701
----------	----------	----------	----------



5TH DRAWER

GBAT0501	GAAT0811
	GCAT1101



315PCS W/8-Drawer Tool Trolley

7 DRAWER TOOLS

PRO-PLUS SERIES GRAY
Satin Chrome Finished

1ST DRAWER

GAAT2403	GAAT2202
	GCAT2402



2ND DRAWER

GCAT5001	GCAT2001	GAAT2302	GAAT1202
----------	----------	----------	----------



3RD DRAWER

GAAT0702	GAAT1003	GAAT0502	GAAT0802
----------	----------	----------	----------



4TH DRAWER

GAAT0817	GAAT0814
	GAAT1604



5TH DRAWER

GAAT0805	GAAT0807	GBAT0501	GCAT1807
----------	----------	----------	----------



W/8-Drawer Tool Trolley - 315PCS Mechanical Tool Set

	CONTENTS	DESCRIPTION
1 ST	GAAT2403	24 1/2" Dr. Bit Socket Set
	GAAT2202	22 1/2" Dr. Deep Flank Socket Set
	GCAT2402	24 1/2" Dr. Socket Set
2 ND	GCAT5001	50 1/4" Dr. Socket Set
	GCAT2001	20 3/8" Dr. Socket Set
	GAAT2302	23 Star Wrench, Sockets & Key Wrench Set
3 RD	GAAT1202	12 1/2" Dr. Bit Socket Set
	GAAT0702	7 Double End Swivel-Socket Wrench Set
	GAAT1003	10 Double Open End Wrench Set
4 TH	GAAT0502	5 Flare Nut Wrench Set
	GAAT0802	8 75° Offset Double Ring Wrench Set
	GAAT0817	8 Pro-Series Ratchet Combination Wrench Set
5 TH	GAAT0814	8 L-Type Two Way Hex Key Wrench Set
	GAAT1604	16 15" Offset Hi-Performance Combination Wrench Set
	GAAT0805	8 Slotted & Phillips Screwdriver Set
6 TH	GAAT0807	8 Star Tamperproof Screwdriver Set
	GBAT0501	5 File Set
	GCAT1807	18 1/2" Dr. Flank Impact Socket Set
7 TH	GBAT0303	3 Adjustable Wrench & Pliers Set
	GBAT0402	4 Pliers Assortment Set
	GBAT0401	4 Retaining Ring Pliers Set
7 TH	GBAT0201	2 Pipe Wrench & Ball Peen Hammer Set
	GCAT0701	7 Chisels & Hammers Set
	GCAT0801	8 Hacksaw, Adjustable Wrench & Pin Punch Set
	GCAT1101	11 Measuring, Marking & Cutting Tool Set

6TH DRAWER

GBAT0303	GBAT0402	GBAT0401	GBAT0201
----------	----------	----------	----------



7TH DRAWER

GCAT0701	GCAT0801
	GCAT1101



Master Tool Sets

157PCS Tools of Workbench

- TOPTUL Heavy Duty Workbench with Wall Cabinet
- Sturdy Construction for Workshop Applications

ITEM NO. **TAAD1602** Heavy Duty Wall Cabinet
(W)1560 x (D)200 x (H)603 mm

ITEM NO. **TAAA1607** Heavy Duty Workbench
(W)1560 x (D)710 x (H)827 mm

157PCS Master Tool Sets

ITEM NO. **GCAZ0005 (W/3)** Drawer Tool Chest
(W)687 x (D)459 x (H)360 mm

ITEM NO. **TCAB0501 (W/5)** Small 5-Drawer Tool Trolley
(W)569 x (D)340 x (H)769 mm



Assortment Of Tools In Workbench

Mechanical Tool Set

ITEM NO.	DESCRIPTION
TCAB0501	1 Small 5-Drawer Tool Trolley (W)569x(D)340x(H)769 mm
TAAA1607	1 Heavy Duty Workbench (W)1560x(D)710x(H)827 mm
TAAD1602	1 Heavy Duty Wall Cabinet (W)1560x(D)200x(H)603 mm (per cabinet include 20pcs single hook - 2")
GCAZ0005	157PCS Professional Mechanical Tool Set W/3-Drawer Tool Chest (W)687x(D)459x(H)360 mm

157PCS Master Tool Sets

ITEM NO. **GCAZ0005 (W/3)** Drawer Tool Chest
(W)687 x (D)459 x (H)360 mm

Satin Chrome Finished

W/3-Drawer Tool Chest - 157PCS Professional Mechanical Tool Set

	CONTENTS	DESCRIPTION
1 ST	GCAT0701	7 Chisels & Hammers Set
	GCAT2402	24 1/2" Dr. Socket Set
	GCAT7202	72 1/4" Dr. Socket & Ball Point Hex Key Wrench Set
2 ND	GBAT0303	3 Adjustable Wrench & Pliers Set
	GBAT0402	4 Pliers Assortment Set
	GBAT0401	4 Retaining Ring Pliers Set
3 RD	GAAT0805	8 Slotted & Phillips Screwdriver Set
	GAAT0802	8 75° Offset Double Ring Wrench Set
	GAAT1603	16 15° Offset Super-Torque Combination Wrench Set
	GCAT1101	11 Measuring, Marking & Cutting Tool Set



1ST DRAWER

GCAT0701	GCAT2402
	GCAT7202



2ND DRAWER

GBAT0303	GBAT0402	GBAT0401	GAAT0805
----------	----------	----------	----------



3RD DRAWER

GAAT0802	GAAT1603
	GCAT1101



TOPTUL[®]

All TOPTUL high quality drawer insert tool sets are currently designed with 2 interchangeable insert tray sizes (A&B) allowing users to mix and match their personal favourites or the most suitable tool selection within each drawer.

TOPTUL your best working partner.



Master Tool Sets

PLASTIC TRAY:

All TOPTUL high quality drawer tool sets are currently designed with 2 interchangeable insert sizes (A&B) allowing users to personalise by mixing and matching suitable tool sets to place within each drawer.

Additional 1/3, 1/2 and full size drawer tool sets are also available in order to satisfy each individuals demand.

A



W 136 x D 364 x H 43 (mm)

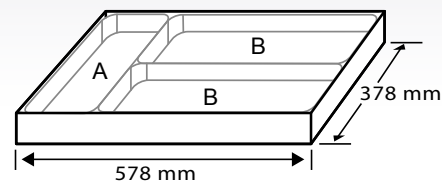
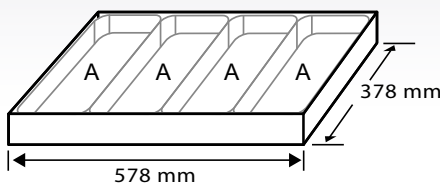

4PCS

Satin Chrome Finished

15° Offset Super-Torque Combination Wrench Set



ITEM NO.	CONTENTS	10 (SET)
GAAT0407	4 AAEW2727-3232 Super-Torque Combination Wrench 15° Offset 27,29,30,32 mm	

4PCS

Satin Chrome Finished

75° Offset Double Ring Wrench Set



ITEM NO.	CONTENTS	10 (SET)
GAAT0402	4 AA EI2123-2732 Double Ring Wrench 75° Offset 21x23,24x26,25x28,27x32 mm	

8PCS

Satin Chrome Finished

75° Offset Double Ring Wrench Set



ITEM NO.	CONTENTS	10 (SET)
GAAT0802	8 AA EI0607-2022 Double Ring Wrench 75° Offset 6x7,8x9,10x11,12x13,14x15,16x17, 18x19,20x22 mm	

13PCS

Satin Chrome Finished

15° Offset Super-Torque Combination Wrench Set (METRIC)



ITEM NO.	CONTENTS	10 (SET)
GAAT1302	13 AA EW0808-2424 Super-Torque Combination Wrench 15° Offset 8,10,11,12,13,14,15,16,17,18,19, 22,24 mm	

13PCS

Satin Chrome Finished

15° Offset Hi-Performance Combination Wrench Set (METRIC)



ITEM NO.	CONTENTS	10 (SET)
GAAT1301	13 AA EX0808-2424 Hi-Performance Combination Wrench 15° Offset 8,10,11,12,13,14,15,16,17,18,19, 22,24 mm	

13PCS

Satin Chrome Finished

15° Offset Standard Combination Wrench Set (METRIC)



ITEM NO.	CONTENTS	10 (SET)
GAAT1303	13 AA EB0808-2424 Standard Combination Wrench 15° Offset 8,10,11,12,13,14,15,16,17,18,19, 22,24 mm	

18PCS

Satin Chrome Finished

Double Open End Wrench & Hex Key Wrench Set



ITEM NO.	CONTENTS	10 (SET)
GAAT1802	9 GAAL0910 Short Type Hex Key Wrench Set 1,5,2,2,5,3,4,5,6,8,10 mm 9 AA EJ0607-2224 Double Open End Wrenches 6x7,8x9,10x11,12x13,14x15,16x17, 18x19,20x22,22x24 mm	

4PCS

Satin Chrome Finished

Double Open End Wrench Set



ITEM NO.	CONTENTS	10 (SET)
GAAT0406	4 AA EJ2123-2732 Double Open End Wrenches 21x23,24x26,25x28,27x32 mm	

12PCS

Satin Chrome Finished

Pro-Series Reversible Ratchet Combination Wrench Set



ITEM NO.	CONTENTS	10 (SET)
GAAT1205	12 AB AF0808-1919 Pro-Series Reversible Ratchet Combination Wrenches 8,9,10,11,12,13,14,15,16,17,18,19 mm	

5PCS Satin Chrome Finished
Flare Nut Wrench Set



ITEM NO.	CONTENTS	10 (SET)
GAAT0502	5 AEEA0809~1922 Flare Nut Wrenches 8x9,10x11,12x13,14x17,19x22 mm	

7PCS Satin Chrome Finished
Double End Swivel-Socket Wrench Set



ITEM NO.	CONTENTS	10 (SET)
GAAT0702	7 AEEC0607~1819 Double End Swivel-Socket Wrenches 6x7,8x9,10x11,12x13,14x15,16x17, 18x19 mm	

18PCS Black Phosphate Finished
1/2" DR. Flank Impact Socket Set



ITEM NO.	CONTENTS	10 (SET)
GCAT1807 (6PT)	17 KABA1610~1632 1/2" Dr. 6PT Flank Impact Sockets 10,11,12,13,14,15,16,17,18,19,21,22, 23,24,27,30,32 mm 1 KACE1605 1/2" Dr. Impact Extension Bar - 5" (L)	

24PCS Satin Chrome Finished
1/2" DR. Bit Socket Set



ITEM NO.	CONTENTS	10 (SET)
GAAT2402	7 BCDA1604~1612 1/2" Dr. Hex Bit Sockets 4,5,6,7,8,10,12 mm 5 BCCA1608~1616 1/2" Dr. Slotted Bit Sockets 8,10,12,14,16 mm 3 BCAA16P2~16P4 1/2" Dr. Phillips Bit Sockets PH2,PH3,PH4 9 BCFA1620~1660 1/2" Dr. Star Bit Sockets T20,T25,T27,T30,T40,T45,T50,T55,T60	

24PCS Satin Chrome Finished
1/2" DR. Bit Socket Set



ITEM NO.	CONTENTS	10 (SET)
GAAT2403	2 BCAA16P2 & 16P3 1/2" Dr. Phillips Bit Sockets PH2 & PH3 7 BCDA1604~1612 1/2" Dr. Hex Bit Sockets 4,5,6,7,8,10,12 mm 6 BCHA1606~1616 1/2" Dr. Spline Bit Sockets M6,M8,M10,M12,M14,M16 9 BCFA1620~1660 1/2" Dr. Star Bit Sockets T20,T25,T27,T30,T40,T45,T50,T55,T60	

23PCS Satin Chrome Finished
Star Wrench, Sockets & Key Wrench Set



ITEM NO.	CONTENTS	10 (SET)
GAAT2302	4 BAED0804~0808 1/4" Dr. Star Sockets E4,E5,E6,E8 6 BAED1610~1620 1/2" Dr. Star Sockets E10,E12,E14,E16,E18,E20 4 AAEE0608~2024 Star Wrench E6xE8,E10xE12,E14xE18,E20xE24 9 GAAL0913 Short Type Star Key Wrench Set T10,T15,T20,T25,T27,T30,T40,T45,T50	

25PCS Satin Chrome Finished
3/8" DR. Flank Socket Set



ITEM NO.	CONTENTS	10 (SET)
GCAT2502 (6PT)	18 BAEA1206~1224 3/8" Dr. 6PT Flank Sockets 6,7,8,9,10,11,12,13,14,15,16,17,18,19, 20,21,22,24 mm 1 CAHA1254 3/8" Dr. Universal Joint 2 CAAA1203 & 1206 3/8" Dr. Extension Bar - 3" & 6" (L) 2 BAAT1216 & 1221 3/8" Dr. Magnetic Spark Plug Socket 16 & 21 mm 1 CTCK1220 3/8" Dr. Sliding T- Handle 1 CJBG1220 3/8" Dr. 36 Teeth Reversible Ratchet Handle with Quick Release	

18PCS Satin Chrome Finished
3/8" DR. Flank Socket Set



ITEM NO.	CONTENTS	10 (SET)
GCAT1808 (6PT)	13 BAEA1206~1224 3/8" Dr. 6PT Flank Sockets 6,7,8,10,11,12,13,14,17,19,21,22,24 mm 1 CAHA1254 3/8" Dr. Universal Joint 2 CAAA1203 & 1206 3/8" Dr. Extension Bar - 3" & 6" (L) 1 CFAC1210 3/8" Dr. Swivel Handle - 10" (L) 1 CJB1220 - 6PT 3/8" Dr. 72 Teeth Reversible Ratchet Handle with Quick Release	

12PCS Satin Chrome Finished
1/2" DR. Bit Socket Set



ITEM NO.	CONTENTS	10 (SET)
GAAT1202	1 BCTA1605 1/2" Dr. Extra Long Hex Bit Socket 5 mm (L=180mm) 2 BCEA1607 & 1608 1/2" Dr. Long Hex Bit Sockets 7 & 8 mm (L=100mm) 2 BCIA1606 & 1610 1/2" Dr. Extra Long Hex Bit Sockets 6 & 10 mm (L=140mm) 4 BCJA1606~1612 1/2" Dr. Long Spline Bit Sockets M6, M8, M10, M12 (L=100mm) 2 BCKA1640 & 1645 1/2" Dr. Extra Long Star Tamperproof Bit Sockets T40 & T45 (L=120mm) 1 BCVA1655 1/2" Dr. Extra Long Star Tamperproof Bit Sockets T55 (L=140mm)	

Master Tool Sets

A

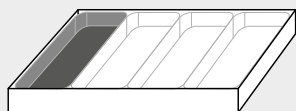

W136 x D364 x H43 (mm)

4PCS Pliers Assortment Set



ITEM NO.	CONTENTS	10 (SET)
GBAT0402	<ul style="list-style-type: none"> 1 DBBB2207 Combination Pliers - 7" (L) 1 DEBC2207 Heavy Duty Diagonal Cutting Pliers - 7" (L) 1 DFBB2208 Long Nose Pliers - 8" (L) 1 DFBA2208 Bent Nose Pliers - 8" (L) 	

6PCS Go-Thru Slotted & Phillips Screwdriver Set (Hexagon Steel & Hexagon Driver)



ITEM NO.	CONTENTS	10 (SET)
GAAT0601	<ul style="list-style-type: none"> 2 FBGB0108 & 0210 Go-Thru Phillips Screwdrivers (Hexagon Steel & Hexagon Driver) PH1x75 & PH2x100 4 FAGB5E10~1020 Go-Thru Slotted Screwdrivers (Hexagon Steel & Hexagon Driver) 5.5x100, 6.5x150, 8x175, 10x200 	

4PCS Retaining Ring Pliers Set



ITEM NO.	CONTENTS	10 (SET)
GBAT0401	<ul style="list-style-type: none"> 1 DCAA1207 90° Retaining Ring Pliers (External Ring) 7" (L) 1 DCAB1207 Straight Retaining Ring Pliers (External Ring) 7" (L) 1 DCAC1207 90° Retaining Ring Pliers (Internal Ring) 7" (L) 1 DCAD1207 Straight Retaining Ring Pliers (Internal Ring) 7" (L) 	

151PCS Hand Riveter Set



ITEM NO.	CONTENTS	10 (SET)
GAAT0101	<ul style="list-style-type: none"> 1 JBAA2448 - Hand Riveter 30 ALCA0308 Aluminum Rivets - Ø3.2x8 mm 30 ALCA0410 Aluminum Rivets - Ø4x10 mm 30 ALCA0510 Aluminum Rivets - Ø4.8x10 mm 30 ALCB0407 Stainless Rivets - Ø4x7 mm 30 ALCB0510 Stainless Rivets - Ø4.8x10 mm 	

8PCS Slotted & Phillips Screwdriver Set



ITEM NO.	CONTENTS	10 (SET)
GAAT0805	<ul style="list-style-type: none"> 3 FBAB0108-0315 Phillips Anti-Slip Screwdrivers PH1x80, PH2x100, PH3x150 1 FBBB0203 Stubby Phillips Anti-Slip Screwdriver PH2x25 3 FAAB0410-6E15 Slotted Anti-Slip Screwdrivers 4x100, 5.5x100, 6.5x150 1 FABB6E03 Stubby Slotted Anti-Slip Screwdriver 6.5x25 	

5PCS File Set



ITEM NO.	CONTENTS	10 (SET)
GBAT0501	<ul style="list-style-type: none"> 1 SDBB0821 Flat File - 8" (L) 1 SDBE0815 Triangle File - 8" (L) 1 SDBC0821 Half Round File - 8" (L) 1 SDBA0808 Square File - 8" (L) 1 SDBD0808 Round File - 8" (L) 	

3PCS Adjustable Wrench & Pliers Set



ITEM NO.	CONTENTS	10 (SET)
GBAT0303	<ul style="list-style-type: none"> 1 DAAQ1A10 Curved Jaw Locking Pliers with Wire Cutters - 10" (L) 1 DDBA2210 Box-Joint Water Pump Pliers 10" (L) 1 AMAA3325 Paw Adjustable Wrench 10" (L) 	

8PCS Star Screwdriver Set



ITEM NO.	CONTENTS	10 (SET)
GAAT0813	<ul style="list-style-type: none"> 8 FFAB0908-4015 Star Anti-Slip Screwdrivers T9, T10, T15, T20, T25, T27, T30, T40 	

2PCS Pipe Wrench & Ball Peen Hammer Set



ITEM NO.	CONTENTS	10 (SET)
GBAT0201	<ul style="list-style-type: none"> 1 HAAC1635 Ball Peen Hammer - (16oz) 1 DDAB1A14 Pipe Wrench - 14" (L) 	

7PCS Chisels & Hammers Set



ITEM NO.	CONTENTS	10 (SET)
GCAAT0701	<ul style="list-style-type: none"> 5 GAAV0501 Chisel Punch Set 1 HAAA0330 Engineers Hammer (300g) 1 HAAB1038 Dead Blow Hammer (16oz) 	

8PCS Star Tamperproof Screwdriver Set



ITEM NO.	CONTENTS	10 (SET)
GAAT0807	<ul style="list-style-type: none"> 8 FEAB0908-4015 Star Tamperproof Anti-Slip Screwdrivers T9, T10, T15, T20, T25, T27, T30, T40 	



TOPTUL
YOUR BEST WORKING PARTNERS

Master Tool Sets

B

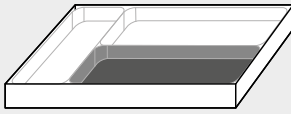

W434 x D176 x H43 (mm)

All TOPTUL high quality drawer tool sets are currently designed with 2 interchangeable insert sizes (A&B) allowing users to personalise by mixing and matching suitable tool sets to place within each drawer.

Additional 1/3, 1/2 and full size drawer tool sets are also available in order to satisfy each individuals demand.

72PCS

1/4" DR. Socket & Ball Point Hex Key Wrench Set

Satin Chrome Finished



ITEM NO.	CONTENTS	10 (SET)
GCAT7202 (6PT)	<ul style="list-style-type: none"> 13BAEA0804~0814 1/4" Dr. 6PT Flank Sockets 4,4.5,5.5,6,7,8,9,10,11,12,13,14 mm 13BAEE0804~0814 1/4" Dr. 6PT Deep Flank Sockets 4,4.5,5.5,6,7,8,9,10,11,12,13,14 mm 7BCDA082E~0808 1/4" Dr. Hex Bit Sockets 2.5,3,4,5,6,7,8 mm 6BCCA0803~0808 1/4" Dr. Slotted Bit Sockets 3,4,4.5,5,6,5,8 mm 5BCAA08P0~08P4 1/4" Dr. Phillips Bit Sockets PH0,PH1,PH2,PH3,PH4 4BCBA08P0~08P3 1/4" Dr. Pozi Bit Sockets PZ0,PZ1,PZ2,PZ3 8BCFA0808~0840 1/4" Dr. Star Bit Sockets T8,T10,T15,T20,T25,T27,T30,T40 1CJBM0815 1/4" Dr. 72 Teeth Reversible Ratchet Handle with Quick Release 3CAAA0802~0806 1/4" Dr. Extension Bar - 2", 4", 6" (L) 1CTCK0811 1/4" Dr. Sliding T- Handle 1CAHA0840 1/4" Dr. Universal Joint 1CAIA0815 1/4" Dr. Spinner Handle 9GAAL0916 Long Type Ball Point Hex Key Wrench Set 1.5,2,2.5,3,4,5,6,8,10 mm 	

11PCS

Measuring, Marking & Cutting Tool Set



ITEM NO.	CONTENTS	10 (SET)
GCAT1101	<ul style="list-style-type: none"> 1SBAA0414 Multi-Purpose Electricians Scissors 1HBAF0135 Auto Center Punch 1ICAC0022 Screw Pitch Gauges 4~48(SAE) 1ICAB0024 Screw Pitch Gauges 0.25~6(METRIC) 1ICAA0020 20 Sizes Metric Tapered Feeler Gauge 1IAAA0005 5M - Measuring Tape 1SCAA2017 Heavy Duty Utility Knife 1IDAA0212 Steel Scriber 1IACA0150 Stainless Steel Vernier Caliper 1IBAA0150 Stainless Steel Protractor 1IABA0300 Stainless Steel Straight Ruler 30 cm 	

8PCS

Torque Wrench, Adaptor & Ratchet Handle Set



ITEM NO.	CONTENTS	5 (SET)
GCAT0803	<ul style="list-style-type: none"> 2BAAT1616 & 1621 1/2" Dr. Magnetic Spark Plug Sockets 16 & 21 mm 1ANAF1211 3/8" Dr. Torque Wrench (19-110Nm) 1CAEA1208 3/8"(F) x 1/4"(M) Dr. Adaptor 1CAGA1216 3/8"(F) x 1/2"(M) x 17.2 mm 3-Way Adaptor - 44 mm (L) 1CJD10812 1/4" Dr. 45 Teeth Stubby Reversible Ratchet Handle with Quick Release 1CJHM1228 3/8" Dr. 72 Teeth Flexible Reversible Ratchet Handle with Quick Release 1CJLN1632 1/2" Dr. 72 Teeth Reversible Swivel Head Ratchet Handle 	

8PCS

Hacksaw, Adjustable Wrench & Pin Punch Set



ITEM NO.	CONTENTS	10 (SET)
GCAT0801	<ul style="list-style-type: none"> 1AMAB2920 Adjustable Wrench - 8" (L) 6GAAV0601 2x8x115,3x8x125,4x9.5x150,5x9.5x165,6x12.7x180,8x12.7x180 mm 1SAAA3013 Heavy Duty Hacksaw 	

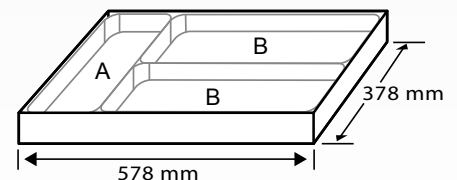

16PCS Satin Chrome Finished
15° Offset Super-Torque Combination Wrench Set



ITEM NO.	CONTENTS	10 (SET)
GAAT1603	16AAEW0606-2424 Super-Torque Combination Wrench 15° Offset 6,7,8,9,10,11,12,13,14,15,16,17,18,19, 22,24 mm	

16PCS Satin Chrome Finished
15° Offset Standard Combination Wrench Set



ITEM NO.	CONTENTS	10 (SET)
GAAT1602	16AAEB0606-2424 Standard Combination Wrench 15° Offset 6,7,8,9,10,11,12,13,14,15,16,17,18,19, 22,24 mm	

16PCS Satin Chrome Finished
15° Offset Hi-Performance Combination Wrench Set



ITEM NO.	CONTENTS	10 (SET)
GAAT1604	16AAEX0606-2424 Hi-Performance Combination Wrench 15° Offset 6,7,8,9,10,11,12,13,14,15,16,17,18,19, 22,24 mm	

5PCS Mirror Polished
Half-Moon Ring Wrench Set



ITEM NO.	CONTENTS	10 (SET)
GAAT0504	5AAAC1012-1922 Half Moon Ring Wrenches 10x12,11x13,14x17,16x18,19x22 mm	

22PCS Satin Chrome Finished
1/2" DR. Deep Flank Socket Set



ITEM NO.	CONTENTS	5 (SET)
GAAT2202	20BAEE1608-1632 1/2" Dr. 6PT Deep Flank Sockets (6PT) 8,10,11,12,13,14,15,17,18,19,20,21,22, 23,24,26,27,29,30,32 mm	
GAAT2204	2BAAT1616 & 1621 1/2" Dr. Magnetic Spark Plug Sockets (12PT) 16 & 21 mm	

10PCS Satin Chrome Finished
Angled Socket Wrench Set



ITEM NO.	CONTENTS	5 (SET)
GAAT1002	10AEAE0808-1919 Angled Socket Wrenches 8,10,11,12,13,14,16,17,18,19 mm	

8PCS
L-Type Two Way Ball Point & Hex Key Wrench Set



ITEM NO.	CONTENTS	10 (SET)
GAAT0811	8AGCD0214-1027 L-Type Two Way Ball Point & Hex Key Wrenches  2x140, 2.5x140, 3x140, 4x140, 5x203, 6x203, 8x265, 10x265 mm	

24PCS Satin Chrome Finished
1/2" DR. Flank Socket Set



ITEM NO.	CONTENTS	5 (SET)
GCAT2402	18BAEA1608-1632 1/2" Dr. 6PT Flank Sockets (6PT) 8,9,10,11,12,13,14,15,16,17,19,21,22, 23,24,27,30,32 mm	
	2CAAA1605 & 1610 1/2" Dr. Extension Bar - 5" & 10" (L)	
	1CTCK1625 1/2" Dr. Sliding T- Handle	
	1CAHA1678 1/2" Dr. Universal Joint	
	1CFAC1615 1/2" Dr. Swivel Handle - 15" (L)	
	1CJBM1627 1/2" Dr. 72 Teeth Reversible Ratchet Handle with Quick Release	

8PCS
L-Type Two Way Star & Tamperproof Key Wrench Set



ITEM NO.	CONTENTS	10 (SET)
GAAT0812	8AIED1014-5027 L-Type Two Way Star & Tamperproof Key Wrenches  T10x140, T15x140, T20x140, T25x140, T30x203, T40x203, T45x265, T50x265	

8PCS
VDE Insulated Pliers & Screwdriver Set



ITEM NO.	CONTENTS	10 (SET)
GAAT0809	1DGBCC2106 VDE Insulated Diagonal Cutting Pliers 6" (L)	
	1DGBA2107 VDE Insulated Combination Pliers 7" (L)	
	1DGBB2108 VDE Insulated Long Nose Pliers - 8" (L)	
	2FAEB0410 & 5E13 VDE Insulated Slotted Screwdriver 4x100 & 5.5x125 mm	
	2FBEB0110 & 0210 VDE Insulated Phillips Screwdriver PH1x100 & PH2x100 mm	
	1FAJA0315 Voltage Tester,GS/CE Approval - 145 mm (L)	

8PCS
VDE Insulated Pliers & Screwdriver Set



ITEM NO.	CONTENTS	10 (SET)
GAAT0810	1DGBCC2106 VDE Insulated Diagonal Cutting Pliers 6" (L)	
	1DGBA2107 VDE Insulated Combination Pliers 7" (L)	
	1DGBD2106 VDE Insulated Wire Stripping Pliers - 6" (L)	
	2FAEB0410 & 5E13 VDE Insulated Slotted Screwdrivers 4x100 & 5.5x125 mm	
	2FBEB0110 & 0210 VDE Insulated Phillips Screwdrivers PH1x100 & PH2x100 mm	
	1FAJA0315 Voltage Tester,GS/CE Approval - 145 mm (L)	

Master Tool Sets

186PCS

Professional Mechanical Tool Set

W/9-Drawer Tool Chest

(W)660 x (D)307 x (H)434 mm



ITEM NO. **GCBZ186A**

186PCS

Professional Mechanical Tool Set W/9-Drawer Tool Chest

9 DRAWER TOOLS



Professional Mechanical Tool Set

W/9 DRAWER TOOL TROLLEY

186PCS

ITEM NO. **GCBZ186A**

Satin Chrome Finished

186PCS Tool Chest Set

	CONTENTS	DESCRIPTION
	TBAA0901	1 9-Drawer Tool Chest - 660(W)x307(D)x434(H) mm
1 GZA-5001	BAEA0804~0814	13 1/4" Dr. 6PT Flank Sockets 4, 4.5, 5, 5.5, 6, 7, 8, 9, 10, 11, 12, 13, 14 mm
	BBEA0805~0818	11 1/4" Dr. 6PT Flank Sockets 5/32", 3/16", 7/32", 1/4", 9/32", 5/16", 11/32", 3/8", 7/16", 1/2", 9/16"
	BAEA1206~1222	13 3/8" Dr. 6PT Flank Sockets 6, 8, 10, 12, 13, 14, 16, 17, 18, 19, 20, 21, 22 mm
	BBEA1210~1228	11 3/8" Dr. 6PT Flank Sockets 5/16", 3/8", 7/16", 1/2", 9/16", 5/8", 11/16", 3/4", 25/32", 13/16", 7/8"
	BAAT1216~1221	2 3/8" Dr. Magnetic Spark Plug Sockets - 16 & 21 mm
	CJBM0815~1220	2 1/4" & 3/8" Dr. 72 Teeth Reversible Ratchet Handle with Quick Release
	CAIP0816	1 1/4" Dr. Spinner Handle
	CFAC1210	1 3/8" Dr. Swivel Handle - 10" (L)
	CAHK0840~1254	2 1/4" & 3/8" Dr. Super-Torque Universal Joint
	CAAA0803~0806	2 1/4" Dr. Extension Bar - 3" & 6" (L)
2 GZA-1202	CAAA1203~1210	3 3/8" Dr. Extension Bar - 3", 6", 10" (L)
	CTCJ1208	1 3/8" Dr. Sliding T-Handle With Quick Release - 8" (L)
	FAAB0308~6E15	4 Slotted Anti-Slip Screwdrivers 3x75, 4x100, 5.5x100, 6.5x150 mm
	FBAB0108~0210	2 Phillips Anti-Slip Screwdrivers - PH1x80 & PH2x100
3 GZA-0803	FCAB0210	1 Pozidriv Anti-Slip Screwdriver - PZ2x100
	FJAB0213	1 Square Anti-Slip Screwdriver - SQ2x125
	AMAB2920~3325	2 Heavy Duty Adjustable Wrench - 8" & 10" (L)
4 GZA-0304	DDBA2210	1 Box-Joint Water Pump Pliers - 10" (L)
	DEBC2208	1 Heavy Duty Diagonal Cutting Pliers - 8" (L)
5 GZA-0305	DBBB2208	1 Combination Pliers - 8" (L)
	DFBB2208	1 Long Nose Pliers - 8" (L)
	DCAA1207	1 90° Retaining Ring Pliers (External Ring) - 7" (L)
6 GZA-0406	DCAB1207	1 Straight Retaining Ring Pliers (External Ring) - 7" (L)
	DCAC1207	1 90° Retaining Ring Pliers (Internal Ring) - 7" (L)
	DCAD1207	1 Straight Retaining Ring Pliers (Internal Ring) - 7" (L)
	AAEB0606~2424	17 Standard Combination Wrench 15° Offset 6, 8, 10, 11, 12, 13, 14, 15, 16, 17, 18, 19, 20, 21, 22, 23, 24 mm
7 GZC-3101	ACAB0808~3232	14 Standard Combination Wrench 15° Offset 1/4", 5/16", 11/32", 3/8", 7/16", 1/2", 9/16", 5/8", 11/16", 3/4", 13/16", 7/8", 15/16", 1"
	BAEA1610~1632	19 1/2" Dr. 6PT Flank Sockets 10, 11, 12, 13, 14, 15, 16, 17, 18, 19, 21, 22, 23, 24, 26, 27, 29, 30, 32 mm
8 GZC-5702	BBEA1612~1640	14 1/2" Dr. 6PT Flank Sockets 3/8", 7/16", 1/2", 9/16", 5/8", 11/16", 3/4", 13/16", 7/8", 15/16", 1", 1-1/16", 1-1/8", 1-1/4"
	CAHK1678	1 1/2" Dr. Super-Torque Universal Joint
	CAAA1605~1610	2 1/2" Dr. Extension Bar - 5" & 10" (L)
	CTCJ1610	1 1/2" Dr. Sliding T-Handle With Quick Release - 10" (L)
	CFAC1618	1 1/2" Dr. Swivel Handle - 18" (L)
	CJBM1627	1 1/2" Dr. 72 Teeth Reversible Ratchet Handle with Quick Release
	GAAL0916	9 Long Type Ball Point Hex Key Wrench Set 1.5, 2, 2.5, 3, 4, 5, 6, 8, 10 mm
	GBAL0901	9 Long Type Ball Point Hex Key Wrench Set 1/16", 5/64", 3/32", 1/8", 5/32", 3/16", 1/4", 5/16", 3/8"
	SAAA3013	1 Heavy Duty Hacksaw
	DAAQ1A10	1 Curved Jaw Locking Pliers with Wire cutters - 10" (L)
9 GZC-1803	GAAV0601	6 Pin Punch Set 2x8.0x115, 3x8.0x125, 4x9.5x150, 5x9.5x165, 6x12.7x180, 8x12.7x180 mm
	HAAC2440	1 Ball Peen Hammer (24 oz)
	FIAA1615	1 1/2" Dr. Impact Driver - 145mm (L)
	FTAB1610	1 Quick Change Bit Holder 1/2" Dr. x 5/16" (H) - 38mm (L)
	FSAC1008~1010	2 5/16" Hex Shank Slotted Insert Bits 1.2x8 mm & 1.6x10 mm - 36mm (L)
	FSBC1002~1003	2 5/16" Hex Shank Phillips Insert Bits PH2 & PH3 - 36mm (L)
	FBAB0315	1 Phillips Anti-Slip Screwdriver - PH3x150
	FAAB0818	1 Slotted Anti-Slip Screwdriver - 8x175 mm
	FAGB1020	1 Go-Thru Slotted Screwdriver - 10x200 mm

ITEM NO.
GCBZ186A

TOPTUL®

THE MARK OF PROFESSIONAL TOOLS | the choice of professionals

Master Tool Sets



120PCS

Professional Mechanical Tool Set

W/6-Drawer Tool Chest

(W)660 x (D)307 x (H)378 mm

ITEM NO. **GCBZ120A**

120PCS

Professional Mechanical Tool Set W/6-Drawer Tool Chest

6 DRAWER TOOLS

1ST



2ND



3RD



4TH



5TH



6TH



W/6 DRAWER TOOL CHEST

120PCS

ITEM NO. **GCBZ120A**

Satin Chrome Finished

120PCS Tool Chest Set

	CONTENTS	DESCRIPTION
	TBAA0601	1 6-Drawer Tool Chest - 660(W)x307(D)x378(H) mm
	FAAB0308-6E15	4 Slotted Anti-Slip Screwdrivers 3x75, 4x100, 5.5x100, 6.5x150 mm
1 GZA-0803	FBAB0108 & 0210 FCAB0210 FJAB0213	2 Phillips Anti-Slip Screwdrivers - PH1x80 & PH2x100 1 Pozidriv Anti-Slip Screwdriver - PZ2x100 1 Square Anti-Slip Screwdriver - SQ2x125
2 GZA-0304	AMAB2920 & 3325 DDBA2210	2 Heavy Duty Adjustable Wrench - 8" & 10" (L) 1 Box-Joint Water Pump Pliers - 10" (L)
3 GZA-0305	DEBC2208 DBBB2208 DFBB2208	1 Heavy Duty Diagonal Cutting Pliers - 8" (L) 1 Combination Pliers - 8" (L) 1 Long Nose Pliers - 8" (L)
	BAEA1610-1632	19 1/2" Dr. 6PT Flank Sockets 10, 11, 12, 13, 14, 15, 16, 17, 18, 19, 21, 22, 23, 24, 26, 27, 29, 30, 32 mm
	BBEA1612-1640	14 1/2" Dr. 6PT Flank Sockets 3/8", 7/16", 1/2", 9/16", 5/8", 11/16", 3/4", 13/16", 7/8", 15/16", 1", 1-1/16", 1-1/8", 1-1/4"
4 GZC-5702	CAHK1678 CAAA1605 & 1610 CTCJ1610 CFAC1618 CJBM1627 GAAL0916 GBAL0901	1 1/2" Dr. Super-Torque Universal Joint 2 1/2" Dr. Extension Bar - 5" & 10" (L) 1 1/2" Dr. Sliding T-Handle With Quick Release - 10" (L) 1 1/2" Dr. Swivel Handle - 18" (L) 1 1/2" Dr. 72 Teeth Reversible Ratchet Handle with Quick Release 9 Long Type Ball Point Hex Key Wrench Set 1.5, 2, 2.5, 3, 4, 5, 6, 8, 10 mm 9 Long Type Ball Point Hex Key Wrench Set 1/16", 5/64", 3/32", 1/8", 5/32", 3/16", 1/4", 5/16", 3/8"
	AAEB0606-2424	17 Standard Combination Wrench 15° Offset 6, 8, 10, 11, 12, 13, 14, 15, 16, 17, 18, 19, 20, 21, 22, 23, 24 mm
5 GZC-3104	ACEB0808-3232	14 Standard Combination Wrench 15° Offset 1/4", 5/16", 11/32", 3/8", 7/16", 1/2", 9/16", 5/8", 11/16", 3/4", 13/16", 7/8", 15/16", 1"
	SAAA3013 DAAQ1A10 GAAV0601	1 Heavy Duty Hacksaw 1 Curved Jaw Locking Pliers with Wire cutters - 10" (L) 6 Pin Punch Set 2x8x115, 3x8x125, 4x10x150, 5x10x165, 6x12x180, 8x12x180 mm
6 GZC-1803	HAAC2440 FIAA1615 FTAB1610	1 Ball Peen Hammer (24 oz) 1 1/2" Dr. Impact Driver - 145mm (L) 1 Quick Change Bit Holder 1/2" Dr. x 5/16" (H) - 38mm (L)
	FSAC1008 & 1010 FSBC1002 & 1003	2 5/16" Hex Shank Slotted Insert Bits 1.2x8 mm & 1.6x10 mm - 36mm (L) 2 5/16" Hex Shank Phillips Insert Bits PH2 & PH3 - 36mm (L)
	FBAB0315 FAAB0818 FAGB1020	1 Phillips Anti-Slip Screwdriver - PH3x150 1 Slotted Anti-Slip Screwdriver - 8x175 mm 1 Go-Thru Slotted Screwdriver - 10x200 mm

ITEM NO.
GCBZ120A



PROFESSIONAL
MECHANICAL TOOL SET

Master Tool Sets

99PCS Professional Mechanical Tool Set W/3-Drawer Tool Chest

(W)508 x (D)232 x (H)302 mm



ITEM NO. **GCAZ0038**



Satin Chrome Finished

99PCS MECHANICAL TOOL SET

1ST



2ND



3RD



4TH



W/3-Drawer Tool Chest - 99PCS Mechanical Tool Set

CONTENTS	DESCRIPTION
TBAA0303	1 3-Drawer Tool Chest - 508(W)x232(D)x302(H) mm
BAEA0804-0813	12 1/4" Dr. 6PT Flank Sockets 4,4.5,5.5,5.6,7,8,9,10,11,12,13 mm
BCLA0808-0840	8 1/4" Dr. Star Tamperproof Bit Sockets T8,T10,T15,T20,T25,T27,T30,T40
CAHA0840	1 1/4" Dr. Universal Joint - 39 mm (L)
CTCK0811	1 1/4" Dr. Sliding T-Handle - 115 mm (L)
CAAA0802 & 0804	2 1/4" Dr. Extension Bar - 2" & 4" (L)
1 ST CJBG0815	1 1/4" Dr. 36 Teeth Reversible Ratchet Handle with Quick Release - 150 mm (L)
CAIA0815	1 1/4" Dr. Spinner Handle - 150 mm (L)
BAEA1610-1632	20 1/2" Dr. 6PT Flank Sockets 10,11,12,13,14,15,16,17,18,19,20,21,22,23,24,26,27,28,30,32 mm
CAHA1678	1 1/2" Dr. Universal Joint - 71 mm (L)
CTCK1625	1 1/2" Dr. Sliding T-Handle - 250 mm (L)
CAAA1605 & 1610	2 1/2" Dr. Extension Bar - 5" & 10" (L)
CJBG1627	1 1/2" Dr. 36 Teeth Reversible Ratchet Handle with Quick Release - 268 mm (L)
BAAT1616 & 1621	2 1/2" Dr. Magnetic Spark Plug Sockets - 16 & 21 mm
AAEW0808~1919	12 Super Torque Combination Wrench 15° Offset 8,9,10,11,12,13,14,15,16,17,18,19 mm
2 ND HAAA0330	1 Engineers Hammer - (300g)
FBAB0006-0210	3 Phillips Anti-Slip Screwdrivers - PH0x60,PH1x80,PH2x100
FBHB0315	1 Phillips Anti-Slip Screwdriver (Hexagon Steel & Hexagon Driver) - PH3x150
3 RD FBFB0203	1 Stubby Phillips Anti-Slip Screwdriver - PH2x25
FAAB3E10-6E15	4 Slotted Anti-Slip Screwdrivers - 3.5x100,4x100,5.5x150,6.5x150
FAHB0818	1 Slotted Anti-Slip Screwdriver (Hexagon Steel & Hexagon Driver) - 8x175
FABB6E03	1 Stubby Slotted Anti-Slip Screwdriver - 6.5x25
DBBB2207	1 Combination Pliers - 7" (L)
DEBC2207	1 Heavy Duty Diagonal Cutting Pliers - 7" (L)
DFBB2208	1 Long Nose Pliers - 8" (L)
4 TH DDBA2210	1 Box-Joint Water Pump Pliers - 10" (L)
GAAL0914	9 Long Type Star Key Wrench Set T10,T15,T20,T25,T27,T30,T40,T45,T50
GAAL0917	9 Extra Long Ball Point Hex Key Wrench Set 1.5,2,2.5,3,4,5,6,8,10 mm

82PCS Professional Mechanical Tool Set W/3-Drawer Tool Chest

(W)508 x (D)232 x (H)302 mm



ITEM NO. **GCAZ0016**



Satin Chrome Finished

82PCS MECHANICAL TOOL SET



W/3-Drawer Tool Chest - 82PCS Mechanical Tool Set

CONTENTS	DESCRIPTION
TBAA0303	1 3-Drawer Tool Chest - 508(W)x232(D)x302(H) mm
BAEA1207~1221	14 3/8" Dr. 6PT Flank Sockets 7,8,9,10,11,12,13,14,15,16,17,18,19,21 mm
BAEE1207~1221	14 3/8" Dr. 6PT Flank Deep Sockets 7,8,9,10,11,12,13,14,15,16,17,18,19,21 mm
BAAR1216 & 1221	2 3/8" Dr. Spark Plug Sockets 16 & 21 mm
1ST CAHK1254	1 3/8" Dr. High-Torque Universal Joint - 52 mm (L)
CAAA1203~1210	3 3/8" Dr. Extension Bar 3",6",10" (L)
CJHM1228	1 3/8" Dr. 72 Teeth Ratchet Handle with Quick Release
CJBM1220	1 3/8" Dr. 72 Teeth Ratchet Handle with Quick Release
CTCK1220	1 3/8" Dr. Sliding T-Handle - 200 mm (L)
GAAL0917	9 Extra Long Type Ball Point Hex Key Wrench Set 1.5,2,2.5,3,4,5,6,8,10 mm
AAEB0707~1515	9 Standard Combination Wrench 15° Offset 7,8,9,10,11,12,13,14,15 mm
2ND AAEI0607~1617	6 Double Ring Wrench 75° Offset 6x7,8x9, 10x11,12x13,14x15,16x17 mm
AMAA3325	1 Paw Adjustable Wrench 10" (L)
FBBB0203	1 Stubby Phillips Anti-Slip Screwdriver PH2x25
FABB5E03	1 Stubby Slotted Anti-Slip Screwdriver 5.5x25
3RD FAGB5E10 & 6E15	2 Go-Thru Slotted Screwdrivers 5.5x100 & 6.5x150
FBGB0210 & 0315	2 Go-Thru Phillips Screwdrivers PH2x100 & PH3x150
AIEA1015~4021	6 L-Type Two Way Star & Tamperproof Key Wrench T10,T15,T20,T25,T30,T40
DCAA1205	1 90° Retaining Ring Pliers (External Ring) 5" (L)
DCAB1205	1 Straight Retaining Ring Pliers (External Ring) 5" (L)
DCAC1205	1 90° Retaining Ring Pliers (Internal Ring) 5" (L)
DCAD1205	1 Straight Retaining Ring Pliers (Internal Ring) 5" (L)
4TH DDBA2210	1 Box-Joint Water Pump Pliers 10" (L)
DEBB2206	1 Diagonal Cutting Pliers 6" (L)
DBBB2206	1 Combination Pliers - 6" (L)
DFBB2206	1 Long Nose Pliers - 6" (L)
DBBB2207	1 Combination Pliers - 7" (L)
DFBB2208	1 Long Nose Pliers - 8" (L)

Master Tool Sets

62PCS Tool Chest Set



Tool Chest Set

ITEM NO. **GCAZ0057**



Tool Chest Set



20PCS
1/2" DR. Flank Socket Set



6PCS
1/2" DR. Extension Bar & Sliding T-Handle Set



3PCS
Pliers Assortment Set



6PCS
Go-Thru Slotted & Phillips Screwdriver Set
(Hexagon Steel & Hexagon Driver)



20PCS
15° Offset Hi-Performance Combination Wrench &
Extra Long Type Ball Point Hex Key Wrench Set



7PCS
15° Offset Hi-Performance Combination
Wrench Set

Satin Chrome Finished

62PCS Tool Chest Set

	CONTENTS	DESCRIPTION
	TBAC0502	1 3-Section Portable Tool Chest
1	BAEA1610~1632	18 1/2" Dr. 6PT Flank Sockets 10, 11, 12, 13, 14, 15, 16, 17, 18, 19, 20, 21, 22, 23, 24, 27, 30, 32 mm
	CMBG1627	1 1/2" Dr. 36 Teeth Reversible Ratchet Handle with Quick Release
	CAHA1678	1 1/2" Dr. Universal Joint
2	BAAR1621	1 1/2" Dr. Spark Plug Socket - 21mm
	CAAF1602	1 1/2" Dr. Extension Bar (Wobble) - 2" (L)
	CAAA1605 & 1610	2 1/2" Dr. Extension Bar - 5" & 10" (L)
	CTCK1630	1 1/2" Dr. Sliding T-Handle - 12" (L)
	CFAC1615	1 1/2" Dr. Swivel Handle - 15" (L)
3	DBBB2207	1 Combination Pliers - 7" (L)
	DEBB2206	1 Diagonal Cutting Pliers - 6" (L)
	DFBB2206	1 Long Nose Pliers - 6" (L)
4	FAGB5E10~0818	3 Go-Thru Slotted Screwdrivers 5.5x100, 6.5x150, 8x175
	FBGB0108~0315	3 Go-Thru Phillips Screwdrivers PH1x75, PH2x100, PH3x150
5	GAAL0917	9 Extra Long Type Ball Point Hex Key Wrench Set 1.5, 2, 2.5, 3, 4, 5, 6, 8, 10 mm
6	AAEX0606~1616	11 Hi-Performance Combination Wrench 15° Offset 6, 7, 8, 9, 10, 11, 12, 13, 14, 15, 16 mm
	AAEX1717~2424	7 Hi-Performance Combination Wrench 15° Offset 17, 18, 19, 20, 21, 22, 24 mm



Professional Series Portable Tool Chest / Box

Heavy Duty Fully Riveted Hinges
Folding 3-Section Design, Large Storage Capacity
Reinforced Design With Tubular Handles

65PCS Tool Chest Set (W)470 x (D)220 x (H)350 mm

ITEM NO. **GCAZ0003** Satin Chrome Finished

65PCS Tool Chest Set

	CONTENTS	DESCRIPTION
	TBAC0501	1 3-Section Portable Tool Chest
1 GM-0603	FAAB0410~0818	3 Slotted Anti-Slip Screwdrivers 4x100, 6.5x100, 8x175 mm
	FBAB0108~0315	3 Phillips Anti-Slip Screwdrivers PH1x80, PH2x100, PH3x150
2 GM-0811	AAEI0607~2022	8 Double Ring Wrench 75° Offset 6x7, 8x9, 10x11, 12x13, 14x15, 16x17, 18x19, 20x22 mm
3 GM-1315	AAEJ0607~2022	8 Double Open End Wrenches 6x7, 8x9, 10x11, 12x13, 14x15, 16x17, 18x19, 20x22 mm
	GAAV0501	5 Chisel Punch Set
4 GM-2221	BAEA1610~1632	18 1/2" Dr. 6PT Flank Sockets 10, 11, 12, 13, 14, 15, 16, 17, 18, 19, 20, 21, 22, 23, 24, 27, 30, 32 mm
	CJBG1627	1 1/2" Dr. 36 Teeth Reversible Ratchet Handle With Quick Release
	CAHA1678	1 1/2" Dr. Universal Joint
	CAAA1605 & 1610	2 1/2" Dr. Extension Bar - 5" & 10" (L)
	AMAA3325	1 Paw Adjustable Wrench - 10" (L)
	HAAA0330	1 Engineer Hammer (300g)
	HAAB1038	1 Dead Blow Hammer (16 oz)
	DDBA2210	1 Box-Joint Water Pump Pliers - 10" (L)
	DFBB2206	1 Long Nose Pliers - 6" (L)
	DEBB2206	1 Diagonal Cutting Pliers - 6" (L)
DBBB2207	1 Combination Pliers - 7" (L)	
GAAL0910	9 Short Type Hex Key Wrench Set 1.5, 2, 2.5, 3, 4, 5, 6, 8, 10 mm	



Master Tool Sets

63PCS Tool Chest Set

(W)470 x (D)220 x (H)350 mm



One EVA Form Tool Tray at the bottom of the tool chest set



Satin Chrome Finished

ITEM NO. **GCAZ0049**

63PCS Tool Chest Set

	CONTENTS	DESCRIPTION
	TBAC0501	1 3-Section Portable Tool Chest
1	FAAB0410~0818	3 Slotted Anti-Slip Screwdrivers 4x100, 6.5x100, 8x175 mm
	FBAB0108~0315	3 Phillips Anti-Slip Screwdrivers PH1x80, PH2x100, PH3x150
2	AAEB2020~3232	6 Standard Combination Wrench 15° Offset 20, 22, 24, 27, 30, 32 mm
	AAEB0808~1919	8 Standard Combination Wrench 15° Offset 8, 10, 11, 12, 13, 14, 17, 19 mm
3	GAAV0501	5 Chisel Punch Set
	BAEA1610~1632	18 1/2" Dr. 6PT Flank Sockets 10, 11, 12, 13, 14, 15, 16, 17, 18, 19, 20, 21, 22, 23, 24, 27, 30, 32 mm
4	CJBG1627	1 1/2" Dr. 36 Teeth Reversible Ratchet Handle With Quick Release
	CAHA1678	1 1/2" Dr. Universal Joint
	CAAA1605 & 1610	2 1/2" Dr. Extension Bar - 5" & 10" (L)
	CFAC1615	1 1/2" Dr. Swivel Handle - 15" (L)
	HAAC0830	1 Ball Peen Hammer (8 oz)
	HAAB1038	1 Dead Blow Hammer (16 oz)
	DDBA2210	1 Box-Joint Water Pump Pliers - 10" (L)
	DFBB2206	1 Long Nose Pliers - 6" (L)
DEBB2206	1 Diagonal Cutting Pliers - 6" (L)	
DBBB2207	1 Combination Pliers - 7" (L)	
GAAL0916	9 Long Type Ball Point Hex Key Wrench Set 1.5, 2, 2.5, 3, 4, 5, 6, 8, 10 mm	

63PCS

65PCS Tool Chest Set

(W)470 x (D)220 x (H)350 mm



65PCS

ITEM NO. **GCAZ0048**

Satin Chrome Finished

65PCS Tool Chest Set

	CONTENTS	DESCRIPTION
	TBAC0501	1 3-Section Portable Tool Chest
1 GM-0603	FAAB0410-0818	3 Slotted Anti-Slip Screwdrivers 4x100, 6.5x100, 8x175 mm
	FBAB0108-0315	3 Phillips Anti-Slip Screwdrivers PH1x80, PH2x100, PH3x150
2 GM-0811	AAEI0607-2022	8 Double Ring Wrench 75° Offset 6x7, 8x9, 10x11, 12x13, 14x15, 16x17, 18x19, 20x22 mm
3 GM-1315	AAEJ0607-2022	8 Double Open End Wrenches 6x7, 8x9, 10x11, 12x13, 14x15, 16x17, 18x19, 20x22 mm
	GAAV0501	5 Chisel Punch Set
4 GM-2221	BAEA1610-1632	18 1/2" Dr. 6PT Flank Sockets 10, 11, 12, 13, 14, 15, 16, 17, 18, 19, 20, 21, 22, 23, 24, 27, 30, 32 mm
	CJBG1627	1 1/2" Dr. 36 Teeth Reversible Ratchet Handle With Quick Release
	CAHA1678	1 1/2" Dr. Universal Joint
	CAAA1605 & 1610	2 1/2" Dr. Extension Bar - 5" & 10" (L)
	CFAC1615	1 1/2" Dr. Swivel Handle - 15" (L)
	HAAC0830	1 Ball Peen Hammer - (8 oz)
	HAAB1038	1 Dead Blow Hammer (16 oz)
DDBA2210	1 Box-Joint Water Pump Pliers - 10" (L)	
DFBB2206	1 Long Nose Pliers - 6" (L)	
DEBB2206	1 Diagonal Cutting Pliers - 6" (L)	
DBBB2207	1 Combination Pliers - 7" (L)	
GAAL0916	9 Long Type Ball Point Hex Key Wrench Set 1.5, 2, 2.5, 3, 4, 5, 6, 8, 10 mm	



One EVA Form Tool Tray at the bottom of the tool chest set



Master Tool Sets

63PCS Tool Chest Set

ITEM NO. **GCAZ0039**

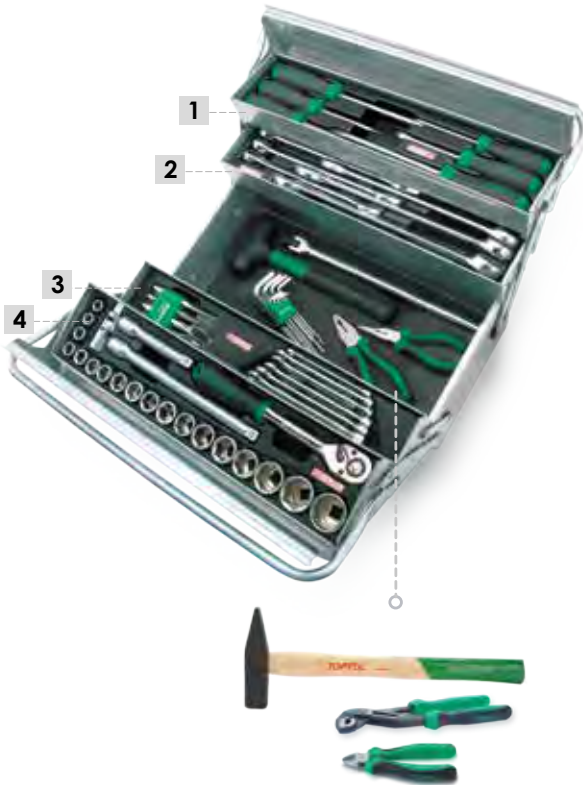

(W)470 x (D)220 x (H)350 mm

Satin Chrome Finished

63PCS Tool Chest Set

	CONTENTS	DESCRIPTION
	TBAC0501	1 3-Section Portable Tool Chest
1 GM-0603	FAAB0410-0818	3 Slotted Anti-Slip Screwdrivers 4x100, 6.5x100, 8x175 mm
	FBAB0108-0315	3 Phillips Anti-Slip Screwdrivers PH1x80, PH2x100, PH3x150
2 GM-0607	AAEB2020-3232	6 Standard Combination Wrench 15° Offset 20, 22, 24, 27, 30, 32 mm
	AAEB0808-1919	8 Standard Combination Wrench 15° Offset 8, 10, 11, 12, 13, 14, 17, 19 mm
3 GM-1314	GAAV0501	5 Chisel Punch Set
	BAEA1610-1632	18 1/2" Dr. 6PT Flank Sockets 10, 11, 12, 13, 14, 15, 16, 17, 18, 19, 20, 21, 22, 23, 24, 27, 30, 32 mm
4 GM-2221	CJBG1627	1 1/2" Dr. 36 Teeth Reversible Ratchet Handle With Quick Release
	CAHA1678	1 1/2" Dr. Universal Joint
	CAAA1605 & 1610	2 1/2" Dr. Extension Bar - 5" & 10" (L)
	CFAC1615	1 1/2" Dr. Swivel Handle - 15" (L)
	HAAA0330	1 Engineer Hammer (300g)
	HAAB1038	1 Dead Blow Hammer (16 oz)
	DDBA2210	1 Box-Joint Water Pump Pliers - 10" (L)
	DFBB2206	1 Long Nose Pliers - 6" (L)
	DEBB2206	1 Diagonal Cutting Pliers - 6" (L)
	DBBB2207	1 Combination Pliers - 7" (L)
	GAAL0916	9 Long Type Ball Point Hex Key Wrench Set 1.5, 2, 2.5, 3, 4, 5, 6, 8, 10 mm

43PCS Tool Bag Set

ITEM NO. **GPN-043A**

(W)365 x (D)200 x (H)65 mm



43PCS Tool Bag Set

Satin Chrome Finished

	CONTENTS	DESCRIPTION
	PPC43372000	1 Tool Bag - (W)365 x (D)200x (H)65 mm
GAAU1301	13	1/4" Dr. Socket Rail Set
		1/4" Dr. 6PT Flank Sockets 4, 5, 6, 7, 8, 9, 10, 11, 12, 13, 14 mm
		1/4" Dr. Universal Joint
		1/4" Dr. x 1/4" (H) Quick Change Bit Holder
GAAV1002	10	1/4" Hex Shank Screwdriver Bit Set
		1/4" (H) Star Insert Bit T10, T15, T20, T25, T27, T30, T40
		1/4" (H) Pozi Insert Bit PZ1, PZ2, PZ3
		1 Stubby Phillips Anti-Slip Screwdriver - PH2x25 mm
	FBAB0006	1 Phillips Anti-Slip Screwdriver - PH0x60 mm
	FBAB0110	1 Phillips Anti-Slip Screwdriver - PH1x100 mm
	FBAB0215	1 Phillips Anti-Slip Screwdriver - PH2x150 mm
	FABB6E03	1 Stubby Slotted Anti-Slip Screwdriver - 6.5x25 mm
	FAAB0308	1 Slotted Anti-Slip Screwdriver - 3.0x75 mm
	FAAB6E15	1 Slotted Anti-Slip Screwdriver - 6.5x150 mm
	CAIP0816	1 1/4" Dr. Spinner Handle
	AGFH0701	7 7-In-1 Folding Hex Key Set 2.5, 3, 4, 5, 6, 8, 10 mm
	AMAB2920	1 Adjustable Wrench - 8" (L)
	DBBB2207	1 Combination Pliers - 7" (L)
	DDBA2210	1 Box-Joint Water Pump Pliers - 10" (L)
	SCAC1817	1 Utility Knife with Spare Blade
	IAAA0005	1 5M Measuring Tape



TOPTUL[®]

THE MARK OF PROFESSIONAL TOOLS is the choice of professionals



Wrenches & Torque Wrenches Series Assortment

of super-torque wrenches supplied in both metric and inch sizes.

WRENCHES & TORQUE WRENCHES SERIES



33

PROFESSIONAL HAND TOOLS

Wrenches & Torque Wrenches

Hi-Performance & Super-Torque Combination Wrench Series. 15° Offset



- AAEX SERIES - HI-PERFORMANCE COMBINATION WRENCH

FOR AUTOMOTIVE REPAIR & MAINTENANCE
(Thin and light weight model for quick tightening & loosening applications)

- AAEW SERIES - SUPER-TORQUE COMBINATION WRENCH

FOR HEAVY DUTY INDUSTRIAL APPLICATIONS
(Strong model for toughest tightening & loosening jobs)

Hi-Performance Combination Wrench 15° Offset

Chrome Vanadium Alloy Steel
Thin profile head and ring for easy access in confined spaces
Light weight model
High torque performance as over 1.6 times as ANSI & DIN standard
Satin chrome finished for maximum durability and corrosion resistance



ITEM NO. Satin	SIZE(mm)	L(mm)		
AAEX5E5E	5.5	104	10	320
AAEX0606	6	104	10	320
AAEX0707	7	114	10	320
AAEX0808	8	124	10	320
AAEX0909	9	131	10	320
AAEX1010	10	143	10	320
AAEX1111	11	151	10	240
AAEX1212	12	160	10	120
AAEX1313	13	169	10	120
AAEX1414	14	180	10	120
AAEX1515	15	192	10	80
AAEX1616	16	198	10	80
AAEX1717	17	206	10	80
AAEX1818	18	214	10	80
AAEX1919	19	223	10	80
AAEX2020	20	236	10	80
AAEX2121	21	243	10	80
AAEX2222	22	255	5	40
AAEX2323	23	266	5	40
AAEX2424	24	274	5	40
AAEX2525	25	284	5	40
AAEX2626	26	294	5	30
AAEX2727	27	304	5	30
AAEX2828	28	315	5	30
AAEX2929	29	327	5	30
AAEX3030	30	340	5	30
AAEX3232	32	355	5	20

Super-Torque Combination Wrench 15° Offset

Chrome Vanadium Alloy Steel
Robust construction design to work under extreme conditions
High torque performance as over 2 times as ANSI & DIN standard
Satin chrome finished for maximum durability and corrosion resistance



ITEM NO. Satin	SIZE(mm)	L(mm)		
AAEW0606	6	104	10	320
AAEW0707	7	114	10	320
AAEW0808	8	124	10	320
AAEW0909	9	131	10	320
AAEW1010	10	143	10	320
AAEW1111	11	151	10	240
AAEW1212	12	160	10	120
AAEW1313	13	169	10	120
AAEW1414	14	180	10	120
AAEW1515	15	192	10	80
AAEW1616	16	198	10	80
AAEW1717	17	206	10	80
AAEW1818	18	214	10	80
AAEW1919	19	223	10	80
AAEW2020	20	236	10	80
AAEW2121	21	243	10	80
AAEW2222	22	255	5	40
AAEW2323	23	266	5	40
AAEW2424	24	274	5	40
AAEW2525	25	284	5	40
AAEW2626	26	294	5	30
AAEW2727	27	304	5	30
AAEW2828	28	315	5	30
AAEW2929	29	327	5	30
AAEW3030	30	340	5	30
AAEW3232	32	355	5	20



POUCH BAG - BLACK
15° Offset Hi-Performance Combination Wrench Set



ITEM NO.	CONTENTS	(SET)
Satin		
GPAX0801	8 10, 11, 12, 13, 14, 15, 17, 19	20
GPAX1202	12 6, 7, 8, 10, 11, 12, 13, 14, 15, 17, 19, 22	10
GPAX1403	12 6, 7, 8, 10, 12, 13, 14, 17, 19, 22, 24, 27, 30, 32	4

ITEM NO.	CONTENTS	(SET)
Satin		
GPAX1601	16 7, 8, 9, 10, 11, 12, 13, 14, 15, 17, 19, 22, 24, 27, 30, 32	4
GPAX2601	26 6, 7, 8, 9, 10, 11, 12, 13, 14, 15, 16, 17, 18, 19, 20, 21, 22, 23, 24, 25, 26, 27, 28, 29, 30, 32	3

POUCH BAG - BLACK
15° Offset Super-Torque Combination Wrench Set



ITEM NO.	CONTENTS	(SET)
Satin		
GPAW0801	8 10, 11, 12, 13, 14, 15, 17, 19	20
GPAW1202	12 6, 7, 8, 10, 11, 12, 13, 14, 15, 17, 19, 22	10
GPAW1403	12 6, 7, 8, 10, 12, 13, 14, 17, 19, 22, 24, 27, 30, 32	4

ITEM NO.	CONTENTS	(SET)
Satin		
GPAW1601	16 7, 8, 9, 10, 11, 12, 13, 14, 15, 17, 19, 22, 24, 27, 30, 32	4
GPAW2601	26 6, 7, 8, 9, 10, 11, 12, 13, 14, 15, 16, 17, 18, 19, 20, 21, 22, 23, 24, 25, 26, 27, 28, 29, 30, 32	3
GPBW1601	16 1/4", 5/16", 3/8", 7/16", 1/2", 9/16", 5/8", 11/16", 3/4", 13/16", 7/8", 15/16", 1", 1-1/16", 1-1/8", 1-1/4"	4

METAL BOX 16PCS
15° Offset Hi-Performance Combination Wrench Set



ITEM NO.	CONTENTS
Satin	
GAAD1603	16 6, 7, 8, 9, 10, 11, 12, 13, 14, 15, 16, 17, 18, 19, 22, 24

METAL CASE: W445 x D188 x H50 (mm)

METAL BOX 16PCS
15° Offset Super-Torque Combination Wrench Set



ITEM NO.	CONTENTS
Satin	
GAAD1604	16 6, 7, 8, 9, 10, 11, 12, 13, 14, 15, 16, 17, 18, 19, 22, 24

METAL CASE: W445 x D188 x H50 (mm)

Wrenches & Torque Wrenches

- Heavy Duty Wrenches Series -



■ Slogging Ring Wrench

- Chrome-Molybdenum Alloy Steel
- Manganese Phosphate Finished



METRIC

■ Single Open End Wrench

- Chrome-Molybdenum Alloy Steel
- Manganese Phosphate Finished



ITEM NO. Black Phosphate	SIZE(mm)	L(mm)		
AAAR2121	21	162	8	96
AAAR2222	22	162	8	96
AAAR2323	23	162	8	96
AAAR2424	24	162	8	96
AAAR2525	25	162	8	96
AAAR2626	26	179	5	60
AAAR2727	27	179	5	60
AAAR2828	28	179	5	60
AAAR2929	29	189	5	60
AAAR3030	30	189	5	60
AAAR3232	32	189	5	60
AAAR3333	33	189	5	60
AAAR3434	34	204	4	32
AAAR3535	35	204	4	32
AAAR3636	36	204	4	32
AAAR3838	38	204	4	32
AAAR4040	40	229	3	24
AAAR4141	41	229	3	24
AAAR4242	42	229	3	24
AAAR4343	43	229	3	24
AAAR4444	44	240	2	16
AAAR4545	45	240	2	16
AAAR4646	46	240	2	16
AAAR4747	47	240	2	16
AAAR4848	48	253	2	16
AAAR5050	50	253	2	16
AAAR5252	52	253	2	16
AAAR5555	55	271	2	12
AAAR6060	60	281	2	12
AAAR6565	65	281	2	12
AAAR7070	70	335	1	6
AAAR7575	75	335	1	6
AAAR8080	80	365	1	4
AAAR8585	85	365	1	4
AAAR9090	90	400	1	2
AAAR9595	95	400	1	2
AAARA0A0	100	435	1	2
AAARA5A5	105	435	1	2

Black Phosphate Finished

ITEM NO. Black Phosphate	SIZE(mm)	L(mm)		
AAAT1616	16	161	10	160
AAAT1717	17	161	10	160
AAAT1818	18	161	10	160
AAAT1919	19	177	10	160
AAAT2020	20	177	10	160
AAAT2121	21	177	10	160
AAAT2222	22	197	6	96
AAAT2323	23	197	6	96
AAAT2424	24	197	6	96
AAAT2525	25	216	6	48
AAAT2626	26	216	6	48
AAAT2727	27	216	6	48
AAAT2828	28	243	6	48
AAAT2929	29	243	6	48
AAAT3030	30	243	6	48
AAAT3232	32	273	5	40
AAAT3333	33	273	5	40
AAAT3434	34	273	5	40
AAAT3535	35	299	5	30
AAAT3636	36	299	5	30
AAAT3838	38	299	5	30
AAAT4141	41	337	4	24
AAAT4242	42	337	4	24
AAAT4343	43	337	4	24
AAAT4444	44	374	3	18
AAAT4545	45	374	3	18
AAAT4646	46	374	3	18
AAAT4848	48	417	3	12
AAAT5050	50	417	3	12
AAAT5555	55	496	2	8
AAAT5858	58	496	2	8
AAAT6060	60	496	2	8

- Heavy Duty Wrenches Series -



Standard Combination Wrench 15° Offset

- Chrome Vanadium Steel Material
- High torque performance as over 1.6 times as ANSI & DIN standard
- Professional quality for maximum durability and corrosion resistance



METRIC

ITEM NO. Satin	SIZE(mm)	L(mm)	Satin Chrome Finished	
AAEB0606	6	109	10	320
AAEB0707	7	119	10	320
AAEB0808	8	129	10	320
AAEB0909	9	139	10	320
AAEB1010	10	149	10	320
AAEB1111	11	159	10	240
AAEB1212	12	169	10	120
AAEB1313	13	179	10	120
AAEB1414	14	189	10	120
AAEB1515	15	199	10	80
AAEB1616	16	209	10	80
AAEB1717	17	219	10	80
AAEB1818	18	229	10	80
AAEB1919	19	239	10	80
AAEB2020	20	249	10	80
AAEB2121	21	259	10	80
AAEB2222	22	269	5	40
AAEB2323	23	279	5	40
AAEB2424	24	289	5	40
AAEB2525	25	299	5	40
AAEB2626	26	309	5	30
AAEB2727	27	319	5	30
AAEB2828	28	329	5	30
AAEB2929	29	339	5	30
AAEB3030	30	349	5	30
AAEB3232	32	369	5	20
AAEB3333	33	409	5	20
AAEB3434	34	409	5	20
AAEB3535	35	409	5	20
AAEB3636	36	439	5	10
AAEB3838	38	439	5	10
AAEB4040	40	479	2	8
AAEB4141	41	479	2	8
AAEB4343	43	479	2	8

Standard Combination Wrench 15° Offset (Jumbo)

- Chrome Vanadium Steel Material
- High torque performance as over 1.6 times as ANSI & DIN standard
- Professional quality for maximum durability and corrosion resistance



METRIC

ITEM NO. Satin	SIZE(mm)	L(mm)	Satin Chrome Finished	
AAEB4545	45	549	2	4
AAEB4646	46	549	2	4
AAEB4848	48	549	2	4
AAEB5050	50	549	2	4
AAEB5555	55	609	2	4
AAEB6060	60	699	1	2
AAEB6565	65	699	1	2
AAEB7070	70	680	1	2
AAEB7575	75	720	1	2
AAEB8080	80	720	1	2

STORAGE RACK

11PCS

15° Offset Standard Combination Wrench Set



Satin Chrome Finished

ITEM NO. Satin	CONTENTS		5 (SET)
GAAC1103	11 8, 10, 11, 12, 13, 14, 15, 16, 17, 18, 19		

Extra Long Combination Wrench 15° Offset

- Chrome Vanadium Steel Material
- Extra long shank for reaching fasteners easily in deep space
- Professional quality for maximum durability and corrosion resistance



Satin Chrome Finished

ITEM NO. Satin	SIZE(mm)	L(mm)		
AAEL1010	10	187	10	120
AAEL1111	11	205	10	80
AAEL1212	12	223	10	80
AAEL1313	13	241	10	80
AAEL1414	14	259	10	80
AAEL1515	15	277	10	80
AAEL1616	16	295	10	80
AAEL1717	17	312	10	60
AAEL1818	18	331	10	60
AAEL1919	19	347	10	60

TRAY

10PCS

15° Offset Extra Long Combination Wrench Set



Satin Chrome Finished

ITEM NO. Satin	CONTENTS		10 (SET)
GAAF1008	10 10, 11, 12, 13, 14, 15, 16, 17, 18, 19		

Wrenches & Torque Wrenches

Standard Combination Wrench 15° Offset

- Chrome Vanadium Steel Material
- High torque performance as over 1.6 times as ANSI & DIN standard
- Professional quality for maximum durability and corrosion resistance



ITEM NO.	SIZE(inch)	L(mm)	Satin Chrome Finished	
ACEB0808	1/4	109	10	320
ACEB1010	5/16	129	10	320
ACEB1111	11/32	139	10	320
ACEB1212	3/8	149	10	320
ACEB1414	7/16	159	10	240
ACEB1616	1/2	179	10	240
ACEB1818	9/16	189	10	120
ACEB2020	5/8	209	10	80
ACEB2222	11/16	219	10	80
ACEB2424	3/4	239	10	80
ACEB2626	13/16	259	10	80
ACEB2828	7/8	269	5	40
ACEB3030	15/16	289	5	40
ACEB3232	1	299	5	40
ACEB3434	1-1/16	319	5	30
ACEB3636	1-1/8	339	5	30
ACEB4040	1-1/4	369	5	20
ACEB4242	1-5/16	409	5	20
ACEB4444	1-3/8	409	5	20
ACEB4646	1-7/16	439	5	10
ACEB4848	1-1/2	439	5	10
ACEB5252	1-5/8	479	2	8
ACEB5454	1-11/16	479	2	8
ACEB5656	1-3/4	549	2	4
ACEB5858	1-13/16	549	2	4
ACEB6060	1-7/8	549	2	4
ACEB6464	2	549	2	4
ACEB6868	2-1/8	609	2	4
ACEB7070	2-3/16	609	2	4
ACEB7272	2-1/4	609	2	4
ACEB7676	2-3/8	699	1	2
ACEB8080	2-1/2	699	1	2

POUCH BAG - BLACK

15° Offset Standard Combination Wrench Set



GPAB1602

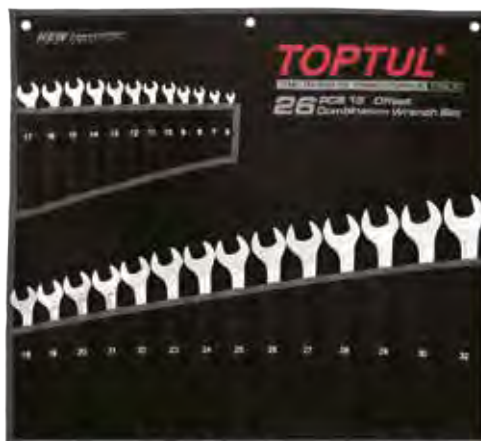

GPAB2602



Mirror Polished

GPBB1601



TOPTUL
Standard Combination Wrench
15° Offset

Satin Chrome/ Mirror Finished

ITEM NO.	CONTENTS	(SET)
GPAB1602 16	7, 8, 9, 10, 11, 12, 13, 14, 15, 17, 19, 22, 24, 27, 30, 32	4
GPAB2602 26	6, 7, 8, 9, 10, 11, 12, 13, 14, 15, 16, 17, 18, 19, 20, 21, 3, 22, 23, 24, 25, 26, 27, 28, 29, 30, 32	4
GPBB1602 16	1/4", 5/16", 3/8", 7/16", 1/2", 9/16", 5/8", 11/16", 3/4", 13/16", 7/8", 15/16", 1", 1-1/16", 1-1/8", 1-1/4"	4

Double Ring Wrench 75° Offset

- Chrome Vanadium Steel Material
- 75° offset ring end in design for convenient operation in recess
- High torque performance as over 1.6 times as ANSI & DIN standard



METRIC

ITEM NO. Satin	SIZE(mm)	L(mm)	Satin Chrome Finished	
AAEI0607	6x7	167	10	120
AAEI0809	8x9	182	10	120
AAEI1011	10x11	197	10	80
AAEI1213	12x13	218	10	80
AAEI1415	14x15	238	10	80
AAEI1617	16x17	258	5	40
AAEI1819	18x19	290	5	40
AAEI2022	20x22	316	5	30
AAEI2123	21x23	316	5	30
AAEI2427	24x27	328	5	30
AAEI2528	25x28	345	5	30
AAEI3032	30x32	360	2	12

POUCH BAG - BLACK

12PCS

75° Offset Double Ring Wrench Set



Satin Chrome Finished

ITEM NO. Satin	CONTENTS	
GPAI1202	12 6x7, 8x9, 10x11, 12x13, 14x15, 16x17, 18x19, 20x22, 21x23, 24x27, 25x28, 30x32	6 (SET)

Double Ring Wrench 45° Offset

- Chrome Vanadium Steel Material
- 45° offset ring end in design for convenient operation in recess
- Professional quality for maximum durability and corrosion resistance



Mirror Polished

ITEM NO. Mirror	SIZE(inch)	L(mm)	Mirror Polished	
ACAH0810	1/4x5/16	165	10	240
ACAH1012	5/16x3/8	170	10	240
ACAH1214	3/8x7/16	180	10	120
ACAH1416	7/16x1/2	206	10	80
ACAH1618	1/2x9/16	206	10	80
ACAH1820	9/16x5/8	232	10	80
ACAH2022	5/8x11/16	237	10	80
ACAH2224	11/16x3/4	270	10	80
ACAH2428	3/4x7/8	292	5	30
ACAH2628	13/16x7/8	292	5	30
ACAH2830	7/8x15/16	327	5	30
ACAH3032	15/16x1	363	5	30
ACAH3236	1x1-1/8	372	5	30
ACAH3436	1-1/16x1-1/8	372	5	30
ACAH3440	1-1/16x1-1/4	392	2	12
ACAH3640	1-1/8x1-1/4	392	2	12
ACAH4046	1-1/4x1-7/16	402	2	12
ACAH4248	1-5/16x1-1/2	440	2	12
ACAH4652	1-7/16x1-5/8	440	2	12
ACAH5258	1-5/8x1-13/16	470	2	8
ACAH5460	1-11/16x1-7/8	470	2	8
ACAH5864	1-13/16x2	510	2	8
ACAH7076	2-3/16x2-3/8	610	2	4
ACAH7278	2-1/4x2-7/16	610	2	4

POUCH BAG - GREEN

8PCS

75° Offset Double Ring Wrench Set

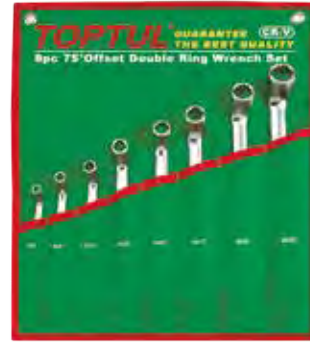

Satin Chrome Finished

ITEM NO. Satin	CONTENTS	
GAAA0810	8 6x7, 8x9, 10x11, 12x13, 14x15, 16x17, 18x19, 20x22	6 (SET)



TOPTUL
DOUBLE RING WRENCHES

Wrenches & Torque Wrenches

▣ Midget Double Ring Wrench 45° Offset

- Chrome Vanadium Steel Material
- Short shank allows convenient operation in confined area
- Professional quality for maximum durability and corrosion resistance



ITEM NO. Mirror	SIZE(mm)	L(mm)	Mirror Polished	
AAAK1011	10x11	116	10	320
AAAK1213	12x13	141	10	160
AAAK1415	14x15	141	10	160
AAAK1617	16x17	158	10	120
AAAK1819	18x19	158	10	120

▣ Midget Combination Wrench 15° Offset

- Chrome Vanadium Steel Material
- Short shank in design for convenient operation in confined area
- Professional quality for maximum durability and corrosion resistance



ITEM NO. Mirror	SIZE(mm)	L(mm)	Mirror Polished	
AAAF0707	7	86	10	320
AAAF0808	8	86	10	320
AAAF0909	9	95	10	320

▣ Midget Combination Wrench 15° Offset

- Chrome Vanadium Steel Material
- Short shank in design for convenient operation in confined area
- Professional quality for maximum durability and corrosion resistance



ITEM NO. Mirror	SIZE(inch)	L(mm)	Mirror Polished	
ACAF1010	5/16	86	10	320
ACAF1111	11/32	95	10	320
ACAF1212	3/8	95	10	320
ACAF1414	7/16	99	10	320
ACAF1616	1/2	107	10	320
ACAF1818	9/16	113	10	160
ACAF2020	5/8	121	10	160
ACAF2222	11/16	127	10	120
ACAF2424	3/4	137	10	120

▣ POUCH BAG - GREEN

15° Offset Midget Combination Wrench Set

10PCS

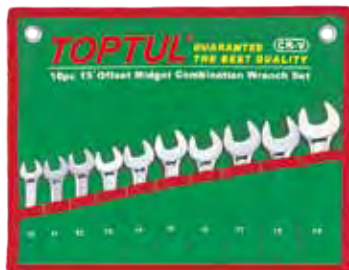

ITEM NO. Mirror	CONTENTS	Mirror Polished
GAAA1001	10 10, 11, 12, 13, 14, 15, 16, 17, 18, 19	20 (SET)

▣ Flat Type Extra-Long Double Ring Wrench

- Chrome Molybdenum Steel Material
- Professional quality for maximum durability and corrosion resistance
- Long shank and thin wall ring end design for reaching bolts easily in deep restricted space



ITEM NO. Mirror	SIZE(mm)	L(mm)	Mirror Polished	
AAAP0810	8x10	230	15	120
AAAP1012	10x12	300	15	90
AAAP1214	12x14	333	10	60
AAAP1417	14x17	365	10	60
AAAP1719	17x19	400	5	30
AAAP2224	22x24	430	5	30

▣ Double Open End Wrench

- Chrome Vanadium Steel Material
- Professional quality for maximum durability and corrosion resistance



ITEM NO. Satin	SIZE(mm)	L(mm)	Satin Chrome Finished	
AAEJ0607	6x7	127	10	320
AAEJ0809	8x9	145	10	320
AAEJ1011	10x11	161	10	240
AAEJ1213	12x13	174	10	120
AAEJ1415	14x15	190	10	120
AAEJ1617	16x17	210	10	80
AAEJ1819	18x19	223	10	80
AAEJ2022	20x22	236	10	80
AAEJ2123	21x23	246	10	60
AAEJ2427	24x27	267	5	40
AAEJ2528	25x28	267	5	40
AAEJ3032	30x32	294	5	40

▣ POUCH BAG - GREEN

Double Open End Wrench Set

12PCS



ITEM NO. Satin	CONTENTS	Satin Chrome Finished
GAAA1206	12 6x7, 8x9, 10x11, 12x13, 14x15, 16x17, 18x19, 20x22, 21x23, 24x27, 25x28, 30x32	6 (SET)

▣ COLOR BOX

75° Offset Standard Combination Wrench Set

8PCS



ITEM NO. Satin	CONTENTS	Satin Chrome Finished
GAAE0811	8 8, 10, 12, 13, 14, 17, 19, 22	10 (SET)

Standard Combination Wrench 75° Offset

- Chrome Vanadium Steel Material
- Professional quality for maximum durability and corrosion resistance
- 75° offset ring end in design for operating easily in recess



ITEM NO. Satin	SIZE(mm)	L(mm)	Satin Chrome Finished	
AAEN0606	6	110	10	320
AAEN0707	7	120	10	320
AAEN0808	8	130	10	320
AAEN0909	9	140	10	320
AAEN1010	10	150	10	160
AAEN1111	11	160	10	240
AAEN1212	12	170	10	160
AAEN1313	13	180	10	120
AAEN1414	14	190	10	120
AAEN1515	15	205	10	80
AAEN1616	16	215	10	80
AAEN1717	17	225	10	80
AAEN1818	18	235	10	80
AAEN1919	19	255	5	40
AAEN2020	20	255	5	40
AAEN2121	21	285	5	40
AAEN2222	22	285	5	40
AAEN2323	23	315	5	30
AAEN2424	24	315	5	30

Star Wrench

- Chrome Vanadium Steel Material
- Useful for removing E-Torx fasteners
- Professional quality for maximum durability and corrosion resistance



ITEM NO. Satin	SIZE	L(mm)	Satin Chrome Finished	
AAEE0608	E6xE8	113	10	320
AAEE1012	E10xE12	142	10	320
AAEE1418	E14xE18	181	10	240
AAEE2024	E20xE24	224	5	40

Half-Moon Ring Wrench

- Chrome Vanadium Steel Material
- Special purpose tool for hard to reach starter bolts
- Professional quality for maximum durability and corrosion resistance



ITEM NO. Mirror	SIZE(mm)	L(mm)	Mirror Polished	
AAAC1012	10x12	142	10	160
AAAC1113	11x13	166	5	80
AAAC1417	14x17	190	5	80
AAAC1618	16x18	220	5	40
AAAC1922	19x22	256	5	40

POUCH BAG - BLACK

75° Offset Standard Combination Wrench Set

12PCS



ITEM NO. Satin	CONTENTS	Satin Chrome Finished
GPA1201	128, 10, 11, 12, 13, 14, 16, 17, 18, 19, 21, 22	6 (SET)

6PT - Flare Nut Wrench

- Chrome Vanadium Steel Material
- Thick head feature ensures a strong grip on the nut and avoids damages
- Useful for tightening and loosening flare nuts at line connections
- Specially designed for use with nuts fitted in hydraulic, oil and compressed air systems



METRIC

ITEM NO. Satin	SIZE(mm)	L(mm)	Satin Chrome Finished	
AAEA0809	8x9	130	15	240
AAEA1011	10x11	150	10	160
AAEA1213	12x13	170	10	120

POUCH BAG - BLACK

Flare Nut Wrench Set

5PCS



ITEM NO. Satin	CONTENTS	Satin Chrome Finished
GPAQ0502	5 8x10, 11x13, 12x14, 17x19, 22x24	10 (SET)

12PT - Flare Nut Wrench

- Chrome Vanadium Steel Material
- Thick head feature ensures a strong grip on the nut and avoids damages
- Useful for tightening and loosening flare nuts at line connections
- Specially designed for use with nuts fitted in hydraulic, oil and compressed air systems



METRIC

ITEM NO. Satin	SIZE(mm)	L(mm)	Satin Chrome Finished	
AAEA1417	14x17	190	5	60
AAEA1922	19x22	230	5	40
AAEA2427	24x27	265	5	40

Wrenches & Torque Wrenches

Pro-Series

Reversible Ratchet Combination Wrench

- Chrome Vanadium Steel Material
- Two-way reversible gear design for quick and easy fastening and loosening works
- 72 teeth ratchet mechanism, 5° increments
- High torque & durable ratcheting performance
- Stain chrome plated finish



ITEM NO.	SIZE(mm)	L(mm)	Satin Chrome Finished	
ABAF0808	8	140	10	320
ABAF0909	9	149	10	320
ABAF1010	10	158	10	160
ABAF1111	11	165	10	120
ABAF1212	12	171	10	120
ABAF1313	13	178	10	120
ABAF1414	14	190	10	120
ABAF1515	15	199	10	80
ABAF1616	16	208	10	80
ABAF1717	17	225	10	80
ABAF1818	18	236	10	80
ABAF1919	19	247	10	80

Reversible Ratchet Combination Wrench

- Chrome Vanadium Steel Material
- Two-way reversible gear design for quick and easy fastening and loosening works
- 72 teeth gear construction for optimum fastening efficiency with only 5° increment of a turn



ITEM NO.	SIZE(inch)	L(mm)	Satin Chrome Finished	
ADEA1010	5/16	135	10	320
ADEA1212	3/8	155	10	160
ADEA1414	7/16	165	10	120
ADEA1616	1/2	185	10	120
ADEA1818	9/16	195	10	120
ADEA2020	5/8	215	10	80
ADEA2222	11/16	225	10	80
ADEA2424	3/4	245	10	80

METAL BOX

Pro-Series Reversible Ratchet Combination Wrench Set

12PCS



ITEM NO.	CONTENTS	Satin Chrome Finished
Satin		4 (SET)

GAAD1205 128, 9, 10, 11, 12, 13, 14, 15, 16, 17, 18, 19

METAL CASE: W370 x D154 x H50 (mm)

Socket Adaptor With Quick Release (For Ratchet Wrench)

CR-V DIN3123



ITEM NO.	DRIVE	L(mm)	Mirror Polished	
CANA0810	■ 1/4" x ● 10mm	20		
CANA1213	■ 3/8" x ● 13mm	24	10	180
CANA1619	■ 1/2" x ● 19mm	32	10	180

1/4" Square Drive & Bit Holder Swivel Wrench

- Chrome Vanadium Steel Material
- Swivel head design for working in areas with restricted access



Quick Change 1/4" (Hex) Bit Holder



1/4" Drive Socket Adaptor

ITEM NO.	SIZE	L(mm)	Dual Finished	
Dual				
AREA0808	■ 1/4" Dr. x ◻ 1/4"	185	10	80



TOPTUL
REVERSIBLE RATCHET COMBINATION WRENCH

▣ Ratchet Combination Wrench

Chrome Vanadium Steel Material
72 Teeth Ratchet Mechanism



ITEM NO. Satin	SIZE(mm)	L(mm)	Satin Chrome Finished	
AOAA0808	8	135	10	320
AOAA0909	9	158	10	160
AOAA1010	10	158	10	160
AOAA1111	11	164	10	120
AOAA1212	12	167	10	120
AOAA1313	13	176	10	120
AOAA1414	14	190	10	120
AOAA1515	15	199	10	80
AOAA1616	16	205	10	80
AOAA1717	17	223	10	80
AOAA1818	18	235	10	80
AOAA1919	19	245	10	80
AOAA2222	22	278	5	40
AOAA2424	24	308	5	40

▣ Stubby Ratchet Combination Wrench

Chrome Vanadium Steel Material
72 Teeth Ratchet Mechanism



ITEM NO. Satin	SIZE(mm)	L(mm)	Satin Chrome Finished	
AOAB0909	9	95	10	320
AOAB1010	10	95	10	320
AOAB1111	11	105	10	320
AOAB1212	12	105	10	320
AOAB1313	13	106	10	320
AOAB1414	14	115	10	160
AOAB1515	15	122	10	160
AOAB1616	16	122	10	160
AOAB1717	17	125	10	120
AOAB1818	18	138	10	120
AOAB1919	19	138	10	120

▣ Ratchet Double E-Star Ring Wrench

Chrome Vanadium Steel Material
Useful for removing external E-star fasteners quickly
72 teeth ratcheting mechanism for optimum fastening efficiency



ITEM NO. Satin	SIZE	L(mm)	Satin Chrome Finished	
AOAC0608	E6xE8	130	10	160
AOAC1012	E10xE12	144	10	160
AOAC1418	E14xE18	181	10	80
AOAC2024	E20xE24	224	10	80

▣ Flexible Ratchet Combination Wrench

Chrome Vanadium Steel Material
72 Teeth Ratchet Mechanism (5° increments)
Satin Chrome Finished
The pivoting flexible ratchet ring head allows for 180 degree operation in confined spaces
Compact ring head enables to work in tight spaces where a ratchet and socket would not fit
Ideal for applications that present problems in terms of congestion, visibility and accessibility



ITEM NO. Satin	SIZE(mm)	L(mm)	Satin Chrome Finished	
AOAD0808	8	136	10	320
AOAD0909	9	158	10	320
AOAD1010	10	158	10	320
AOAD1111	11	175	10	120
AOAD1212	12	175	10	120
AOAD1313	13	185	10	120
AOAD1414	14	193	10	120
AOAD1515	15	213	10	80
AOAD1616	16	213	10	80
AOAD1717	17	231	10	80
AOAD1818	18	249	10	80
AOAD1919	19	249	10	80

▣ Ratchet Double Ring Wrench

Chrome Vanadium Steel and special heat treatments provides thin walls for strength
72 teeth ratcheting system provides high torque and 5 degrees of operation in tight areas



ITEM NO. Satin	SIZE(mm)	L(mm)	Satin Chrome Finished	
AEAR0809	8x9	131	10	320
AEAR1011	10x11	144	10	160
AEAR1213	12x13	166	10	160
AEAR1415	14x15	181	10	120
AEAR1618	16x18	206	10	80
AEAR1719	17x19	224	10	80

▣ POUCH BAG - BLACK

Ratchet Combination Wrench Set

12PCS



ITEM NO. Satin	CONTENTS	Satin Chrome Finished
GPAQ1202	12 8, 9, 10, 11, 12, 13, 14, 15, 16, 17, 18, 19	10 (SET)

Wrenches & Torque Wrenches

Pipe Wrench

Cast iron body
Chrome molybdenum jaw



ITEM NO.	SIZE/LENGTH (inch)	JAW OPENING CAPACITY Ø (inch)		
DDAB1A08	8	1	5	40
DDAB1A10	10	1-1/2	5	20
DDAB1A12	12	2	2	12
DDAB1A14	14	2	2	8
DDAB1A18	18	2-1/2	2	4
DDAB1A24	24	3	2	4
DDAB1A36	36	5	1	2
DDAB1A48	48	6	1	1

Aluminum Alloy Pipe Wrench

Aluminum alloy body
Chrome molybdenum jaw
Extra hardened jaw and deep milled teeth provide maximum strength at stress point
Balanced for proper weight distribution



ITEM NO.	SIZE/LENGTH (inch)	JAW OPENING CAPACITY Ø (inch)		
DDAC1A14	14	2	2	8
DDAC1A18	18	2-1/2	2	4
DDAC1A24	24	3	2	4
DDAC1A36	36	5	1	2
DDAC1A48	48	6	1	1

Adjustable Hook Spanner Wrench

Made of Chrome Vanadium Alloy Steel
Ideal for adjusting collars, lock nut rings and bearings
Five sizes cover the full range of conventional fixed wrenches

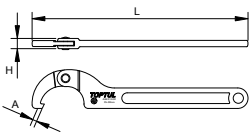

Satin Finished

ITEM NO.	Diameter Capacity (mm)	Hook Depth (A) (mm)	Hook Thickness (H) (mm)	Overall Length (L) (mm)		
AEEX1A35	13-35	3.5	9	170	5	60
AEEX1A50	35-50	4.5	10	215	5	40
AEEX1A80	50-80	5.5	12	285	5	40
AEEX1AA2	80-120	6.0	13	345	5	30
AEEX1AA8	120-180	8.0	15	465	2	8

Paw Adjustable Wrench

Chrome Vanadium Steel Material
Millimeter graduation head for quick adjustment
Handle weight less by 10% and over 18% wider jaw opening increase torsional rigidity and useful range of fastener sizes
Rubber (TPR) cushion handle provides a comfortable and strong grip



ITEM NO.	SIZE (inch/mm)	MAXIMUM JAW OPENING WIDTH (mm)	L (mm)		
AMAA2415	6"(150mm)	23.9	165	5	90
AMAA2920	8"(200mm)	28.6	210	5	90
AMAA3325	10"(250mm)	32.8	260	5	30
AMAA3830	12"(300mm)	38.1	310	5	30

Heavy Duty Adjustable Wrench

Chrome Vanadium Steel Material
Millimeter graduation head for quick adjustment
Industrial-grade quality for maximum durability and corrosion resistance



ITEM NO.	SIZE (inch/mm)	MAXIMUM JAW OPENING WIDTH (mm)	L (mm)		
AMAB1710	4"(100mm)	17.0	110	10	60
AMAB2415	6"(150mm)	23.9	160	10	60
AMAB2920	8"(200mm)	28.6	205	10	40
AMAB3325	10"(250mm)	32.8	255	10	30
AMAB3830	12"(300mm)	38.1	305	5	20
AMAB5038	15"(375mm)	50.0	380	2	4
AMAB6045	18"(450mm)	60.0	460	2	4

Open-End Ratcheting Wrench

Chrome Molybdenum Steel Open-End
Chrome Vanadium Steel Handle
Special purpose tool for hard to reach starter bolts
Professional quality for maximum durability and corrosion resistance



Satin Finished

ITEM NO.	SIZE (mm)	L (mm)		
AEAT1010	10	156	10	160
AEAT1111	11	156	10	160
AEAT1313	13	156	10	160
AEAT1717	17	210	10	80
AEAT1919	19	212	10	80
AEAT2222	22	220	10	80

4-Way Wheel Nut Wrench

Chrome Vanadium Steel Material
Specially designed handle for quick removal of wheel bolts



ITEM NO.	SIZE	L(inch)	Dual Finished	
Dual				
AEAL1616	17 x 19 x 21mm x 1/2" Dr.	16	5	15

Flexible Drivers with Sliding T-Handle

Made of Chrome Vanadium Steel Material
Easy to use T-handle tools
Use 1/4", 3/8" or 1/2" square drive attachments such as sockets, hex drives, crow's foot or swivels

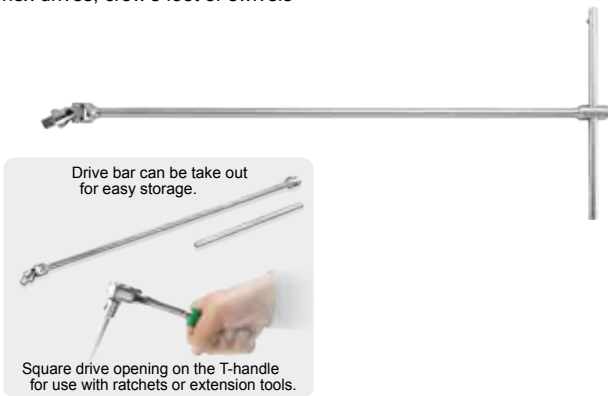

ITEM NO.	DRIVE	Extension Drive	L1 (mm)	L (mm)	Satin Chrome Finished	
Satin						
CTLA0840	1/4"	1/4"	160	400	10	40
CTLA1245	3/8"	3/8"	200	450	10	40
CTLA1650	1/2"	1/2"	230	500	10	20

Hex Nut Driver T-Handle

Chrome Vanadium Steel Material

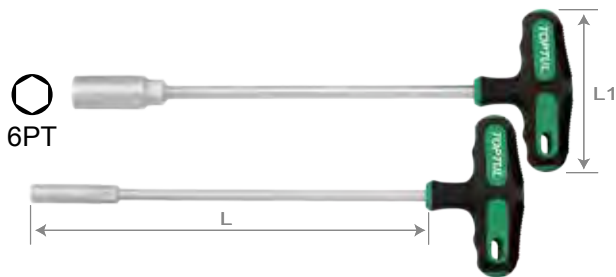

ITEM NO.	SIZE(mm)	L1(mm)	L(mm)	Satin Chrome Finished	
Satin					
CTJA0523	5	95	230	5	30
CTJA0623	6	95	230	5	30
CTJA0723	7	95	230	5	30
CTJA0823	8	95	230	5	30
CTJA0923	9	95	230	5	30
CTJA1023	10	95	230	5	30
CTJA1123	11	95	230	5	30
CTJA1223	12	95	230	5	30
CTJA1323	13	95	230	5	30
CTJA1423	14	95	230	5	30

Foldable Cross Rim Wrench

Chrome Vanadium Steel Material

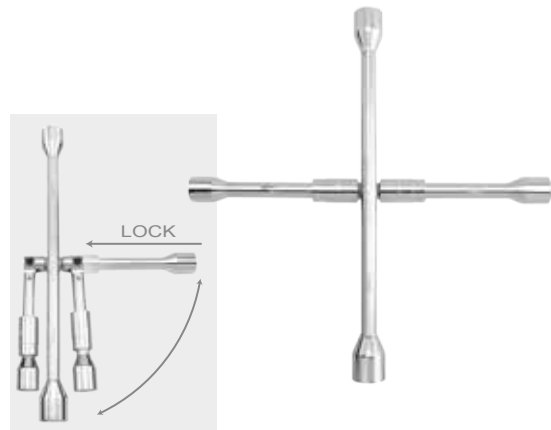

ITEM NO.	SIZE(mm)	L(inch)	Mirror Polished	
Mirror				
AEAQ2214	17 x 19 x 21 x 22	14	4	16

Sliding T-Handle Socket Wrench



ITEM NO.	SIZE (mm)	L1 (mm)	L (mm)	Mirror Polished	
Mirror					
CTDA0831	8	200	310	10	40
CTDA0931	9	200	310	10	40
CTDA1031	10	200	310	10	40
CTDA1131	11	200	310	10	40
CTDA1231	12	200	310	10	40
CTDA1331	13	200	310	10	40
CTDA1431	14	200	310	10	40
CTDA1731	17	200	310	10	40
CTDA1931	19	200	310	10	40

8PCS

Hex Nut Driver T-Handle Set



ITEM NO.	GZC0802	
CONTENTS	5 (SET)	
8 CTJA0723-CTJA1423	Hex Nut Driver T-Handle	
	7, 8, 9, 10, 11, 12, 13, 14 mm	
	PLASTIC BOX: W373 x D289 x H56 (mm)	

Wrenches & Torque Wrenches

8PCS

3/8" Dr. 6PT Flare Nut Crowfoot Wrench Set (SAE)



Satin Finished
10 (SET)

ITEM NO. CONTENTS

GBAR0801 8 AFAV1212~1228
3/8", 7/16", 1/2", 9/16", 5/8", 11/16", 3/4", 7/8"

10PCS

3/8" Dr. 6PT Flare Nut Crowfoot Wrench Set (METRIC)



Satin Finished
10 (SET)

ITEM NO. CONTENTS

GAAR1001 10 AEA1210~1219
10, 11, 12, 13, 14, 15, 16, 17, 18, 19 mm

Ratchet Head

CR-MO Steel Ratchet Head
24 teeth



ITEM NO.	HEAD SIZE	DRIVE	L(mm)		
ANAL0412	9x12	3/8"	56	25	100
ANAL0216	14x18	1/2"	78	10	40
ANAL0116	14x18	1/2"	94	10	40

3/8" Dr. 6PT Flare Nut Crowfoot Wrench

Made of drop forged Chrome Molybdenum Alloy Steel
Designed to provide access to the hard to reach fasteners
Oversized wrench surfaces grip multiple sides to reduce rounding
Chrome plated for maximum durability and corrosion resistance
Ideal for use on soft fittings in aluminum, copper and brass

CR-MO



ITEM NO.	SIZE(mm)	L(mm)	Satin Finished	
AEAV1210	10	36	40	400
AEAV1211	11	38	40	400
AEAV1212	12	38	40	400
AEAV1213	13	43	30	300
AEAV1214	14	43	30	300
AEAV1215	15	44	30	300
AEAV1216	16	44	30	300
AEAV1217	17	48	30	300
AEAV1218	18	48	30	300
AEAV1219	19	49	30	300

Spanner Head

CR-V Steel Head



ITEM NO.	HEAD SIZE	SIZE(mm)	L(mm)		
ANAK0113	14x18	13	63	20	80
ANAK0114	14x18	14	63	20	80
ANAK0115	14x18	15	64	20	80
ANAK0116	14x18	16	64	20	80
ANAK0117	14x18	17	64	20	80
ANAK0119	14x18	19	65	20	80
ANAK0122	14x18	22	66	10	40
ANAK0124	14x18	24	67	10	40
ANAK0127	14x18	27	70	10	40
ANAK0130	14x18	30	74	10	40
ANAK0132	14x18	32	77	10	40

2PCS

1/4" Hex Drive Torque Screwdriver Set

Reduced weight and size specifically designed for low torque application
Clockwise operation device
Easy to read window scale
1/4" female hexagon drive for use with 1/4" hexagon bits
Ease of use, additional 1/4" female square drive on the handle accommodates T-handle, ratchet handle and etc.
Micrometer scale graduation: 0.1 Nm
Actuation accuracy: ±6% tolerance of the set scale value
Test certificate in accordance with DIN EN ISO 6789 national standard



ITEM NO. CONTENTS

GCAI0202 1 ANBD0808
1/4" Hex Drive Torque Screwdriver
1.5~8 Nm (L=162mm)
1 CTCK0811
1/4" Dr. Sliding T-Handle (L=115mm)

30 (SET)

BLOW CASE: W200 x D68 x H57 (mm)



TOPTUL
MICRO ADJUSTABLE TORQUE WRENCH

Wrenches & Torque Wrenches

TOPTUL

MICRO ADJUSTABLE TORQUE WRENCH

▣ Micrometer Adjustable Torque Wrench (Window Display)

- Chrome Vanadium Steel Ratchet Head
- Flip reverse ratchet action
- Spring ball socket retention and push-button quick release
- Push to lock / pull to unlock scale setting feature
- Large digits for exact and easy-to-read torque setting
- Convex display simplifies reading
- Ergonomically designed, Nylon material anti-slip handle
- Tolerance of torque accuracy $\pm 3\%$



ITEM NO.	DRIVE	CAPACITY	L(mm)	45 Gears
ANAM0803	1/4"	1-25Nm	290	10
ANAM1205	3/8"	5-50Nm	360	10
ANAM1610	1/2"	10-100Nm	405	10
ANAM1620	1/2"	20-200Nm	500	10
ANAM1630	1/2"	60-300Nm	595	10
ANAM1640	1/2"	80-400Nm	680	10

▣ Torque Wrench

- CR-MO Steel Ratchet Head
- Equip flip reverse ratchet action function
- Unique push to lock/pull to unlock scale setting feature
- Tolerance of torque accuracy $\pm 4\%$



Torque Wrench
- ANAA2470 (140-700Nm)

ITEM NO.	DRIVE	CAPACITY	L(mm)	24 Gears
ANAA2470	3/4"	140-700Nm	1092	4
ANAA3298	1"	140-980Nm	1230	2

▣ 11PCS

1/2" DR. Head-Interchangeable Spanner Torque Wrench Set



ITEM NO.	CONTENTS	4 (SET)
GAAI1101	<ul style="list-style-type: none"> 1 ANAH0121 14x18 Head Size Interchangeable Torque Handle (40-210Nm) 1 ANAL0116 1/2" Dr. Ratchet Head 9 ANAK0113~0130 Spanner Head 13, 14, 15, 17, 19, 22, 24, 27, 30 mm 	

BLOW CASE: W545 x D146 x H55 (mm)

▣ Torque Wrench

- CR-V/CR-MO Steel Ratchet Head
- Equip flip reverse ratchet action function
- Unique push to lock/pull to unlock scale setting feature
- Ergonomically designed, TPR material anti-slip handle
- Tolerance of torque accuracy $\pm 4\%$



ITEM NO.	DRIVE	CAPACITY	L(mm)	24 Gears
ANAF0803	1/4"	6-30Nm	350	20
ANAF1211	3/8"	19-110Nm	385	12
ANAF1621	1/2"	40-210Nm	535	10
ANAF1635	1/2"	70-350Nm	645	6
ANAF2450	3/4"	100-500Nm	865	4

▣ Interchangeable Torque Handle



ITEM NO.	HEAD SIZE	CAPACITY	L(mm)	10
ANAH0121	14x18	40-210Nm	509	

▣ Interchangeable Torque Handle (Window Display)



ITEM NO.	HEAD SIZE	CAPACITY	L(mm)	6
ANAJ0130	14x18	60-300Nm	575	

▣ 11PCS

1/2" DR. Torque Wrench Set



ITEM NO.	CONTENTS	6 (SET)
GAAI1102	<ul style="list-style-type: none"> 1 ANAF1621 1/2" Dr. Torque Wrench (40-210Nm) 6 BAEA1617~1627 1/2" Dr. 6PT Flank Sockets 17, 19, 21, 22, 24, 27 mm 4 BCDA1606~1612 1/2" Dr. Hex Bit Sockets 6, 8, 10, 12 mm 	

BLOW CASE: W588 x D80 x H74 (mm)



Hand Sockets, Bit Sockets & Accessories Series Full

range of flank sockets with maxi-drive. Available in 1/4", 3/8", 1/2", 3/4" & 1".

HAND SOCKETS, BIT SOCKETS & ACCESSORIES SERIES



Hand Sockets, Bit Sockets & Accessories

6PT Sockets

CR-V DIN3124



METRIC

DRIVE	ITEM NO.		SIZE(mm)	L(mm)	Mirror / Satin Chrome Finished	
	Mirror	Satin				
1/4" 6.35mm sq.		BAEA0804	4	25	30	540
		BAEA084E	4.5	25	30	540
		BAEA0805	5	25	30	540
		BAEA085E	5.5	25	30	540
		BAEA0806	6	25	30	540
		BAEA0807	7	25	30	540
		BAEA0808	8	25	20	360
		BAEA0809	9	25	20	360
		BAEA0810	10	25	20	360
		BAEA0811	11	25	10	180
		BAEA0812	12	25	10	180
		BAEA0813	13	25	10	180
		BAEA0814	14	25	10	180
	3/8" 9.5mm sq.		BAEA1206	6	28	15
		BAEA1207	7	28	15	270
		BAEA1208	8	28	15	270
		BAEA1209	9	28	15	270
		BAEA1210	10	28	15	270
		BAEA1211	11	28	15	270
		BAEA1212	12	28	15	270
		BAEA1213	13	28	10	180
		BAEA1214	14	28	10	180
		BAEA1215	15	28	10	160
		BAEA1216	16	28	10	160
		BAEA1217	17	30	10	160
		BAEA1218	18	30	10	160
		BAEA1219	19	30	10	160
		BAEA1220	20	30	10	160
		BAEA1221	21	30	10	160
		BAEA1222	22	30	10	160
		BAEA1224	24	30	10	160
1/2" 12.7mm sq.		BAEA1608	8	38	15	240
		BAEA1609	9	38	15	240
		BAEA1610	10	38	15	240
		BAEA1611	11	38	15	240
		BAEA1612	12	38	15	240
		BAEA1613	13	38	15	240
		BAEA1614	14	38	15	240
		BAEA1615	15	38	15	240
		BAEA1616	16	38	15	240
		BAEA1617	17	38	10	160
		BAEA1618	18	38	10	160
		BAEA1619	19	38	10	160
		BAEA1620	20	38	10	160
		BAEA1621	21	38	10	160
		BAEA1622	22	40	10	160
		BAEA1623	23	40	10	160
		BAEA1624	24	40	10	100
		BAEA1625	25	42	10	100
	BAEA1626	26	42	10	100	
	BAEA1627	27	44	10	100	
	BAEA1628	28	44	10	100	
	BAEA1629	29	44	10	100	
	BAEA1630	30	45	10	100	
	BAEA1631	31	45	10	100	
	BAEA1632	32	45	10	100	

Satin Chrome Finished

DRIVE	ITEM NO. Satin	SIZE(mm)	L(mm)		
3/4" 19.0mm sq.	BAEA2419	19	50	5	80
	BAEA2421	21	50	5	80
	BAEA2422	22	50	5	80
	BAEA2423	23	50	5	80
	BAEA2424	24	50	5	80
	BAEA2426	26	52	5	80
	BAEA2427	27	52	5	80
	BAEA2428	28	52	5	40
	BAEA2429	29	52	5	40
	BAEA2430	30	54	5	40
	BAEA2432	32	56	5	40
	BAEA2433	33	56	5	40
	BAEA2434	34	56	5	40
	BAEA2435	35	58	5	40
	BAEA2436	36	58	5	40
	BAEA2437	37	60	5	40
	BAEA2438	38	60	5	40
	BAEA2439	39	62	5	40
	BAEA2440	40	62	2	16
	BAEA2441	41	64	2	16
	BAEA2442	42	64	2	16
	BAEA2443	43	65	2	16
	BAEA2444	44	66	2	16
	BAEA2445	45	66	2	16
	BAEA2446	46	68	2	16
	BAEA2448	48	70	2	16
	BAEA2450	50	72	2	16
	BAEA2451	51	72	2	16
	BAEA2452	52	72	2	16
	BAEA2454	54	74	2	16
	BAEA2455	55	76	2	16
	BAEA2456	56	76	2	16
BAEA2457	57	76	2	16	
BAEA2458	58	78	2	16	
BAEA2460	60	78	2	16	
BAEA2465	65	82	2	8	
BAEA2470	70	86	2	8	
1" 25.4mm sq.	BAEA3236	36	65	3	24
	BAEA3238	38	65	3	24
	BAEA3241	41	70	3	24
	BAEA3246	46	75	2	16
	BAEA3250	50	75	2	16
	BAEA3254	54	80	2	16
	BAEA3255	55	80	2	16
	BAEA3258	58	80	2	16
	BAEA3260	60	84	2	8
	BAEA3263	63	87	2	8
	BAEA3265	65	87	2	8
	BAEA3267	67	90	2	8
	BAEA3270	70	93	2	8
	BAEA3271	71	93	2	8
	BAEA3275	75	97	2	8
	BAEA3277	77	103	2	8
	BAEA3280	80	103	2	8

10PCS

1/2" DR. 6PT Socket Rail Set



Satin Chrome Finished

ITEM NO. Satin	CONTENTS		
GAAG1007	9 BAEA1608-1622 8, 10, 12, 13, 14, 17, 19, 21, 22 1 AFAN1610 1/2" Dr. L-Handle (90° Offset) - 10" (L)	8	(SET)

13PCS

1/4" DR. 6PT Socket Rail Set



Satin Chrome Finished

ITEM NO.	CONTENTS
Satin	10 (SET)
GAAQ1308	13 BAEA0804-0814 4, 4.5, 5, 5.5, 6, 7, 8, 9, 10, 11, 12, 13, 14

13PCS

3/8" DR. 6PT Socket Rail Set



Satin Chrome Finished

ITEM NO.	CONTENTS
Satin	10 (SET)
GAAQ1310	13 BAEA1207-1221 7, 8, 9, 10, 11, 12, 13, 14, 15, 16, 17, 19, 21

11PCS

1/2" DR. 6PT Socket Rail Set



Satin Chrome Finished

ITEM NO.	CONTENTS
Satin	10 (SET)
GAAQ1103	11 BAEA1610-1622 10, 11, 12, 13, 14, 15, 16, 17, 19, 21, 22

37PCS

1/4", 3/8" & 1/2" DR. 6PT Socket Rail Set



Satin Chrome Finished

ITEM NO.	CONTENTS
Satin	5 (SET)
GAAQ3704	13 BAEA0804-0814 1/4" Dr. - 4, 4.5, 5, 5.5, 6, 7, 8, 9, 10, 11, 12, 13, 14
	13 BAEA1207-1221 3/8" Dr. - 7, 8, 9, 10, 11, 12, 13, 14, 15, 16, 17, 19, 21
	11 BAEA1610-1622 1/2" Dr. - 10, 11, 12, 13, 14, 15, 16, 17, 19, 21, 22

6PT Sockets

CR-V DIN3124



SAE

Mirror Polished

DRIVE	ITEM NO.	SIZE(inch)	L(mm)			
1/4" 6.35mm sq.	Mirror					
	BBEA0805	5/32	25	30	540	
	BBEA0806	3/16	25	30	540	
	BBEA0807	7/32	25	30	540	
	BBEA0808	1/4	25	30	540	
	BBEA0809	9/32	25	30	540	
	BBEA0810	5/16	25	20	360	
	BBEA0811	11/32	25	20	360	
	BBEA0812	3/8	25	20	360	
	BBEA0814	7/16	25	10	180	
	BBEA0816	1/2	25	10	180	
	BBEA0818	9/16	25	10	180	
	3/8" 9.5mm sq.	BBEA1208	1/4	28	15	270
		BBEA1210	5/16	28	15	270
		BBEA1211	11/32	28	15	270
		BBEA1212	3/8	28	15	270
		BBEA1214	7/16	28	15	270
		BBEA1216	1/2	28	10	180
BBEA1218		9/16	28	10	180	
BBEA1219		19/32	28	10	160	
BBEA1220		5/8	30	10	160	
BBEA1222		11/16	30	10	160	
BBEA1224		3/4	30	10	160	
BBEA1225		25/32	30	10	160	
BBEA1226	13/16	30	10	160		
BBEA1228	7/8	30	10	160		
1/2" 12.7mm sq.	BBEA1610	5/16	38	15	240	
	BBEA1612	3/8	38	15	240	
	BBEA1614	7/16	38	15	240	
	BBEA1616	1/2	38	15	240	
	BBEA1618	9/16	38	15	240	
	BBEA1619	19/32	38	15	240	
	BBEA1620	5/8	38	15	240	
	BBEA1622	11/16	38	10	160	
	BBEA1624	3/4	38	10	160	
	BBEA1625	25/32	38	10	160	
	BBEA1626	13/16	38	10	160	
	BBEA1628	7/8	40	10	160	
BBEA1630	15/16	40	10	100		
BBEA1632	1	42	10	100		
BBEA1634	1-1/16	44	10	100		
BBEA1636	1-1/8	44	10	100		
BBEA1638	1-3/16	45	10	100		
BBEA1640	1-1/4	45	10	100		

Hand Sockets, Bit Sockets & Accessories

6PT Deep Sockets

CR-V DIN3124



13PCS

1/4" DR. 6PT Deep Socket Rail Set



Satin Chrome Finished

ITEM NO.	CONTENTS
Satin	10 (SET)
GAAQ1309 13	BAEE0804-0814 4, 4.5, 5, 5.5, 6, 7, 8, 9, 10, 11, 12, 13, 14



METRIC

Satin Chrome Finished

DRIVE	ITEM NO. Satin	SIZE(mm)	L(mm)		
1/4" 6.35mm sq.	BAEE0804	4	50	20	360
	BAEE084E	4.5	50	20	360
	BAEE0805	5	50	20	360
	BAEE085E	5.5	50	20	360
	BAEE0806	6	50	20	360
	BAEE0807	7	50	20	360
	BAEE0808	8	50	20	360
	BAEE0809	9	50	20	320
	BAEE0810	10	50	20	320
	BAEE0811	11	50	20	320
	BAEE0812	12	50	20	320
	BAEE0813	13	50	20	320
	BAEE0814	14	50	20	320
	3/8" 9.5mm sq.	BAEE1206	6	63	20
BAEE1207		7	63	20	320
BAEE1208		8	63	20	320
BAEE1209		9	63	10	160
BAEE1210		10	63	10	160
BAEE1211		11	63	10	160
BAEE1212		12	63	10	160
BAEE1213		13	63	10	160
BAEE1214		14	63	10	160
BAEE1215		15	63	10	160
BAEE1216		16	63	10	160
BAEE1217		17	63	10	100
BAEE1218		18	63	10	100
BAEE1219		19	63	10	100
1/2" 12.7mm sq.	BAEE1608	8	77	10	160
	BAEE1609	9	77	10	160
	BAEE1610	10	77	10	160
	BAEE1611	11	77	10	160
	BAEE1612	12	77	10	160
	BAEE1613	13	77	10	160
	BAEE1614	14	77	10	160
	BAEE1615	15	77	10	100
	BAEE1616	16	77	10	100
	BAEE1617	17	77	10	100
	BAEE1618	18	77	10	100
	BAEE1619	19	77	10	100
	BAEE1620	20	77	5	80
	BAEE1621	21	77	5	80
BAEE1622	22	77	5	80	
BAEE1623	23	77	5	50	
BAEE1624	24	77	5	50	
BAEE1625	25	77	5	50	
BAEE1626	26	77	5	50	
BAEE1627	27	77	5	50	
BAEE1628	28	77	5	50	
BAEE1629	29	77	5	50	
BAEE1630	30	77	5	40	
BAEE1632	32	77	5	40	

13PCS

3/8" DR. 6PT Deep Socket Rail Set



Satin Chrome Finished

ITEM NO.	CONTENTS
Satin	5 (SET)
GAAQ1311 13	BAEE1207-1221 7, 8, 9, 10, 11, 12, 13, 14, 15, 16, 17, 19, 21

11PCS

1/2" DR. 6PT Deep Socket Rail Set



Satin Chrome Finished

ITEM NO.	CONTENTS
Satin	5 (SET)
GAAQ1106 11	BAEE1610-1622 10, 11, 12, 13, 14, 15, 16, 17, 19, 21, 22

6PT Deep Sockets

CR-V DIN3124



37PCS

1/4", 3/8" & 1/2" DR. 6PT Deep Socket Rail Set



Satin Chrome Finished

ITEM NO.	CONTENTS
Satin	2 (SET)
GAAQ3703	13 BAEE0804~0814 1/4" Dr. - 4, 4.5, 5, 5.5, 6, 7, 8, 9, 10, 11, 12, 13, 14 13 BAEE1207~1221 3/8" Dr. - 7, 8, 9, 10, 11, 12, 13, 14, 15, 16, 17, 19, 21 11 BAEE1610~1622 1/2" Dr. - 10, 11, 12, 13, 14, 15, 16, 17, 19, 21, 22

DRIVE	ITEM NO.	SIZE(inch)	L(mm)	Mirror Polished
1/4" 6.35mm sq.	BBEE0805	5/32	50	360
	BBEE0806	3/16	50	360
	BBEE0807	7/32	50	360
	BBEE0808	1/4	50	360
	BBEE0809	9/32	50	360
	BBEE0810	5/16	50	360
	BBEE0811	11/32	50	320
	BBEE0812	3/8	50	320
	BBEE0814	7/16	50	320
	BBEE0816	1/2	50	320
	BBEE0818	9/16	50	320
	BBEE1210	5/16	63	320
	BBEE1212	3/8	63	160
	BBEE1214	7/16	63	160
	BBEE1216	1/2	63	160
	BBEE1218	9/16	63	160
	BBEE1220	5/8	63	160
	BBEE1222	11/16	63	100
BBEE1224	3/4	63	100	
BBEE1226	13/16	63	100	
3/8" 9.5mm sq.	BBEE1612	3/8	77	160
	BBEE1614	7/16	77	160
	BBEE1616	1/2	77	160
	BBEE1618	9/16	77	160
	BBEE1620	5/8	77	100
	BBEE1622	11/16	77	100
	BBEE1624	3/4	77	100
	BBEE1626	13/16	77	80
	BBEE1628	7/8	77	80
	BBEE1630	15/16	77	50
	BBEE1632	1	77	50
	BBEE1634	1-1/16	77	50
	BBEE1636	1-1/8	77	50
	BBEE1638	1-3/16	77	50
	BBEE1640	1-1/4	77	50

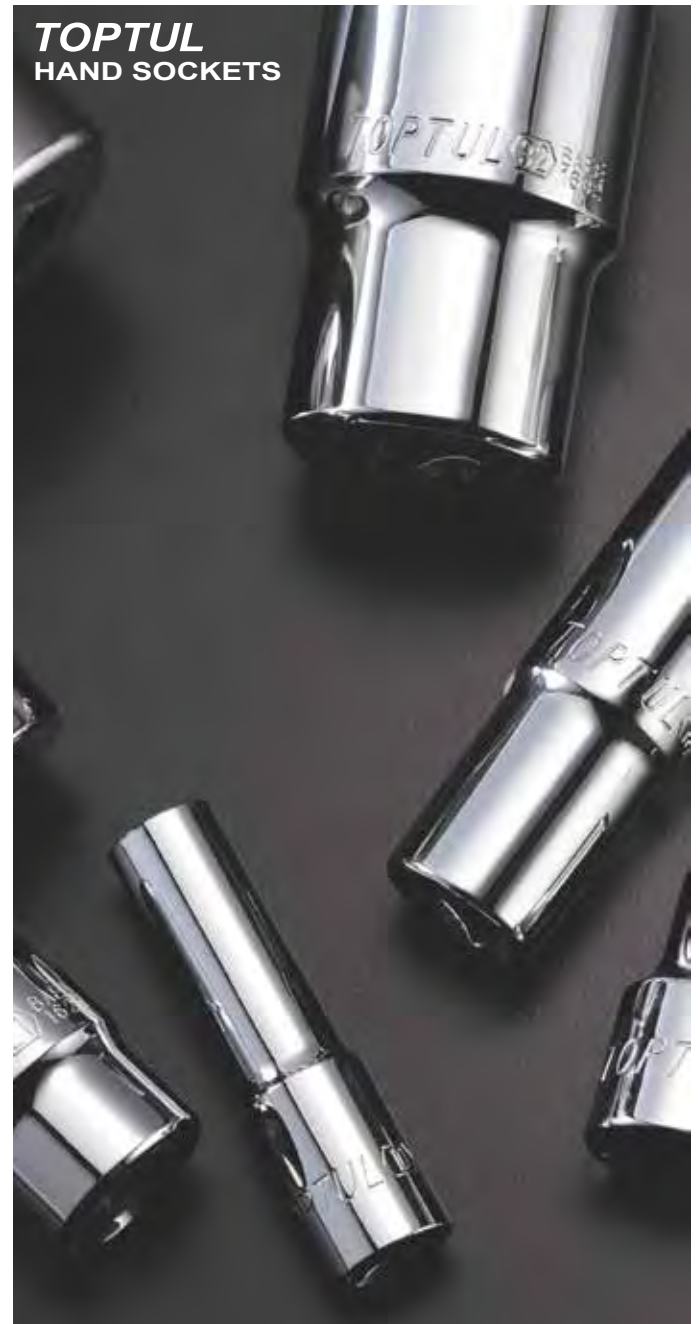

Hand Sockets, Bit Sockets & Accessories

12PT Sockets

CR-V DIN3124



METRIC		Satin Chrome Finished			
DRIVE	ITEM NO. Satin	SIZE(mm)	L(mm)		
 6.35mm sq.	BAEB0804	4	25	30	540
	BAEB084E	4.5	25	30	540
	BAEB0805	5	25	30	540
	BAEB085E	5.5	25	30	540
	BAEB0806	6	25	30	540
	BAEB0807	7	25	30	540
	BAEB0808	8	25	20	360
	BAEB0809	9	25	20	360
	BAEB0810	10	25	20	360
	BAEB0811	11	25	10	180
	BAEB0812	12	25	10	180
	BAEB0813	13	25	10	180
	BAEB0814	14	25	10	180
	 9.5mm sq.	BAEB1206	6	28	15
BAEB1207		7	28	15	270
BAEB1208		8	28	15	270
BAEB1209		9	28	15	270
BAEB1210		10	28	15	270
BAEB1211		11	28	15	270
BAEB1212		12	28	15	270
BAEB1213		13	28	10	180
BAEB1214		14	28	10	180
BAEB1215		15	28	10	160
BAEB1216		16	30	10	160
BAEB1217		17	30	10	160
BAEB1218		18	30	10	160
BAEB1219		19	30	10	160
 12.7mm sq.	BAEB1608	8	38	15	240
	BAEB1609	9	38	15	240
	BAEB1610	10	38	15	240
	BAEB1611	11	38	15	240
	BAEB1612	12	38	15	240
	BAEB1613	13	38	15	240
	BAEB1614	14	38	15	240
	BAEB1615	15	38	15	240
	BAEB1616	16	38	15	240
	BAEB1617	17	38	10	160
	BAEB1618	18	38	10	160
	BAEB1619	19	38	10	160
	BAEB1620	20	38	10	160
	BAEB1621	21	38	10	160
BAEB1622	22	40	10	160	
BAEB1623	23	40	10	160	
BAEB1624	24	40	10	100	
BAEB1625	25	42	10	100	
BAEB1626	26	42	10	100	
BAEB1627	27	44	10	100	
BAEB1628	28	44	10	100	
BAEB1629	29	44	10	100	
BAEB1630	30	45	10	100	
BAEB1632	32	45	10	100	

DRIVE	ITEM NO.	SIZE(mm)	L(mm)	Satin Chrome Finished	
	Satin				
 19.0mm sq.	BAEB2419	19	50	5	80
	BAEB2421	21	50	5	80
	BAEB2422	22	50	5	80
	BAEB2423	23	50	5	80
	BAEB2424	24	50	5	80
	BAEB2426	26	52	5	80
	BAEB2427	27	52	5	80
	BAEB2428	28	52	5	40
	BAEB2429	29	52	5	40
	BAEB2430	30	54	5	40
	BAEB2432	32	56	5	40
	BAEB2433	33	56	5	40
	BAEB2434	34	56	5	40
	BAEB2435	35	58	5	40
	BAEB2436	36	58	5	40
	BAEB2438	38	60	5	40
	BAEB2441	41	64	2	16
	BAEB2446	46	68	2	16
	BAEB2450	50	72	2	16
	BAEB2455	55	76	2	16
	BAEB2460	60	78	2	16
	BAEB2465	65	82	2	8
	BAEB2470	70	86	2	8

11PCS 1/2" DR. 12PT Socket Rail Set



ITEM NO.	CONTENTS	Satin Chrome Finished
GAAQ1102	11 BAEB1610-1622 10, 11, 12, 13, 14, 15, 16, 17, 19, 21, 22	10 (SET)

13PCS 3/8" DR. 12PT Socket Rail Set



ITEM NO.	CONTENTS	Satin Chrome Finished
GAAQ1312	13 BAEB1207-1221 7, 8, 9, 10, 11, 12, 13, 14, 15, 16, 17, 19, 21	10 (SET)

12PT Sockets

CR-V DIN3124



DRIVE	ITEM NO.	SIZE (inch)	L (mm)	Mirror Polished	
	Mirror				
1/4" 6.35mm sq.	BBEB0806	3/16	25	30	540
	BBEB0807	7/32	25	30	540
	BBEB0808	1/4	25	30	540
	BBEB0809	9/32	25	30	540
	BBEB0810	5/16	25	20	360
	BBEB0811	11/32	25	20	360
	BBEB0812	3/8	25	20	360
	BBEB0814	7/16	25	10	180
	BBEB0816	1/2	25	10	180
	BBEB0818	9/16	25	10	180
3/8" 9.5mm sq.	BBEB1208	1/4	28	15	270
	BBEB1210	5/16	28	15	270
	BBEB1211	11/32	28	15	270
	BBEB1212	3/8	28	15	270
	BBEB1214	7/16	28	15	270
	BBEB1216	1/2	28	10	180
	BBEB1218	9/16	28	10	180
	BBEB1219	19/32	28	10	160
	BBEB1220	5/8	30	10	160
	BBEB1222	11/16	30	10	160
	BBEB1224	3/4	30	10	160
	BBEB1226	13/16	30	10	160
	BBEB1228	7/8	30	10	160
	BBEB1610	5/16	38	15	240
BBEB1612	3/8	38	15	240	
BBEB1614	7/16	38	15	240	
BBEB1616	1/2	38	15	240	
BBEB1618	9/16	38	15	240	
BBEB1619	19/32	38	15	240	
BBEB1620	5/8	38	15	240	
BBEB1622	11/16	38	10	160	
BBEB1624	3/4	38	10	160	
BBEB1625	25/32	38	10	160	
BBEB1626	13/16	38	10	160	
BBEB1628	7/8	40	10	160	
BBEB1630	15/16	40	10	100	
BBEB1632	1	42	10	100	
BBEB1634	1-1/16	44	10	100	
BBEB1636	1-1/8	44	10	100	
BBEB1638	1-3/16	45	10	100	
BBEB1640	1-1/4	45	10	100	
BBEB2424	3/4	50	5	80	
BBEB2426	13/16	50	5	80	
BBEB2428	7/8	50	5	80	
BBEB2430	15/16	51	5	80	
BBEB2432	1	52	5	40	
BBEB2434	1-1/16	52	5	40	
BBEB2436	1-1/8	52	5	40	
BBEB2438	1-3/16	54	5	40	
BBEB2440	1-1/4	56	5	40	
BBEB2442	1-5/16	56	5	40	
BBEB2444	1-3/8	58	5	40	
BBEB2446	1-7/16	58	5	40	
BBEB2448	1-1/2	60	5	40	
BBEB2452	1-5/8	64	2	16	
BBEB2454	1-11/16	64	2	16	
BBEB2456	1-3/4	66	2	16	
BBEB2460	1-7/8	70	2	16	
BBEB2464	2	72	2	16	

11PCS

1/2" DR. 12PT Socket Rail Set



Mirror Polished

ITEM NO.	CONTENTS
Mirror	10 (SET)
GBAQ1102 11	BBEB1612-1632 3/8", 7/16", 1/2", 9/16", 5/8", 11/16", 3/4", 13/16", 7/8", 15/16", 1"

13PCS

3/8" DR. 12PT Socket Rail Set



Mirror Polished

ITEM NO.	CONTENTS
Mirror	10 (SET)
GBAQ1301 13	BBEB1208-1228 1/4", 5/16", 11/32", 3/8", 7/16", 1/2", 9/16", 19/32", 5/8", 11/16", 3/4", 13/16", 7/8"



TOPTUL
HAND SOCKETS & ACCESSORIES

Hand Sockets, Bit Sockets & Accessories

12PT Deep Sockets

CR-V DIN3124



METRIC

Satin Chrome Finished

DRIVE	ITEM NO. Satin	SIZE(mm)	L(mm)		
1/4" 6.35mm sq.	BAEF0806	6	50	20	360
	BAEF0807	7	50	20	360
	BAEF0808	8	50	20	360
	BAEF0809	9	50	20	320
	BAEF0810	10	50	20	320
	BAEF0811	11	50	20	320
	BAEF0812	12	50	20	320
	BAEF0813	13	50	20	320
	BAEF1206	6	63	20	320
	BAEF1207	7	63	20	320
	BAEF1208	8	63	20	320
	BAEF1209	9	63	10	160
	BAEF1210	10	63	10	160
3/8" 9.5mm sq.	BAEF1211	11	63	10	160
	BAEF1212	12	63	10	160
	BAEF1213	13	63	10	160
	BAEF1214	14	63	10	160
	BAEF1215	15	63	10	160
	BAEF1216	16	63	10	160
	BAEF1217	17	63	10	100
	BAEF1218	18	63	10	100
	BAEF1219	19	63	10	100
	BAEF1220	20	63	10	100
	BAEF1221	21	63	10	100
	BAEF1222	22	63	10	100
	1/2" 12.7mm sq.	BAEF1608	8	77	10
BAEF1609		9	77	10	160
BAEF1610		10	77	10	160
BAEF1611		11	77	10	160
BAEF1612		12	77	10	160
BAEF1613		13	77	10	160
BAEF1614		14	77	10	160
BAEF1615		15	77	10	100
BAEF1616		16	77	10	100
BAEF1617		17	77	10	100
BAEF1618		18	77	10	100
BAEF1619		19	77	10	100
BAEF1620		20	77	5	80
BAEF1621	21	77	5	80	
BAEF1622	22	77	5	80	
BAEF1623	23	77	5	50	
BAEF1624	24	77	5	50	
BAEF1625	25	77	5	50	
BAEF1626	26	77	5	50	
BAEF1627	27	77	5	50	
BAEF1628	28	77	5	50	
BAEF1629	29	77	5	50	
BAEF1630	30	77	5	40	
BAEF1632	32	77	5	40	

12PT Deep Sockets

CR-V DIN3124



SAE

Mirror Polished

DRIVE	ITEM NO. Mirror	SIZE(inch)	L(mm)		
1/4" 6.35mm sq.	BBEF0806	3/16	50	20	360
	BBEF0807	7/32	50	20	360
	BBEF0808	1/4	50	20	360
	BBEF0809	9/32	50	20	360
	BBEF0810	5/16	50	20	360
	BBEF0811	11/32	50	20	320
	BBEF0812	3/8	50	20	320
	BBEF0814	7/16	50	20	320
	BBEF0816	1/2	50	20	320
	BBEF0818	9/16	50	20	320
	BBEF1208	1/4	63	20	320
	BBEF1210	5/16	63	20	320
	BBEF1212	3/8	63	10	160
3/8" 9.5mm sq.	BBEF1214	7/16	63	10	160
	BBEF1216	1/2	63	10	160
	BBEF1218	9/16	63	10	160
	BBEF1220	5/8	63	10	160
	BBEF1222	11/16	63	10	100
	BBEF1224	3/4	63	10	100
	BBEF1226	13/16	63	10	100
	BBEF1228	7/8	63	10	100

10PCS

1/4" DR. 12PT Deep Socket Rail Set



Mirror Polished

ITEM NO.	CONTENTS	
GBAR1001	10 BBEF0806-0818 3/16", 7/32", 1/4", 9/32", 5/16", 11/32", 3/8", 7/16", 1/2", 9/16"	10 (SET)

11PCS

3/8" DR. 12PT Deep Socket Rail Set



Mirror Polished

ITEM NO.	CONTENTS	
GBAQ1101	11 BBEF1208-1228 1/4", 5/16", 3/8", 7/16", 1/2", 9/16", 5/8", 11/16", 3/4", 13/16", 7/8"	5 (SET)

13PCS

3/8" DR. 12PT Deep Socket Rail Set



Satin Chrome Finished

ITEM NO.	CONTENTS	
GAAQ1313	13 BAEF1207-1221 7, 8, 9, 10, 11, 12, 13, 14, 15, 16, 17, 19, 21	5 (SET)

11PCS

1/2" DR. 12PT Deep Socket Rail Set



Satin Chrome Finished

ITEM NO.	CONTENTS	
GAAQ1105	11 BAEF1610-1622 10, 11, 12, 13, 14, 15, 16, 17, 19, 21, 22	5 (SET)

Star Sockets

CR-V DIN3120



DRIVE	ITEM NO. Satin	SIZE	L(mm)	Satin Chrome Finished	
1/4" 6.35mm sq.	BAED0804	E4	25	30	540
	BAED0805	E5	25	30	540
	BAED0806	E6	25	30	540
	BAED0807	E7	25	30	540
	BAED0808	E8	25	30	540
3/8" 9.5mm sq.	BAED0810	E10	25	20	360
	BAED1208	E8	28	15	270
	BAED1210	E10	28	15	270
	BAED1211	E11	28	15	270
	BAED1212	E12	28	15	270
	BAED1214	E14	28	10	180
	BAED1216	E16	28	10	180
	BAED1218	E18	28	10	160
1/2" 12.7mm sq.	BAED1220	E20	28	10	160
	BAED1610	E10	38	15	240
	BAED1611	E11	38	15	240
	BAED1612	E12	38	15	240
	BAED1614	E14	38	15	240
	BAED1616	E16	38	15	240
	BAED1618	E18	38	15	240
	BAED1620	E20	38	15	240
BAED1622	E22	38	10	160	
BAED1624	E24	38	10	160	

8PCS

3/8" DR. Star Socket Rail Set



ITEM NO. Satin	CONTENTS	Satin Chrome Finished
GAAG0802	8 BAED1208~1220 E8, E10, E11, E12, E14, E16, E18, E20	15 (SET)

7PCS

1/2" DR. Star Socket Rail Set



ITEM NO. Satin	CONTENTS	Satin Chrome Finished
GAAG0704	7 BAED1610~1624 E10, E12, E14, E16, E18, E20, E24	10 (SET)

9PCS

1/2" DR. Star Socket Rail Set



ITEM NO. Satin	CONTENTS	Satin Chrome Finished
GAAG0901	9 BAED1610~1624 E10, E11, E12, E14, E16, E18, E20, E22, E24	10 (SET)

14PCS

1/4", 3/8" & 1/2" DR. Star Socket Rail Set



ITEM NO. Satin	CONTENTS	Satin Chrome Finished
GAAR1402	5 BAED0804~0808 1/4" Dr. - E4, E5, E6, E7, E8 4 BAED1210~1214 3/8" Dr. - E10, E11, E12, E14 5 BAED1616~1624 1/2" Dr. - E16, E18, E20, E22, E24	10 (SET)

Deep Star Sockets

CR-V DIN3120



DRIVE	ITEM NO. Satin	SIZE	L(mm)	Satin Chrome Finished	
1/2" 12.7mm sq.	BAEH1610	E10	77	10	160
	BAEH1612	E12	77	10	160
	BAEH1614	E14	77	10	160
	BAEH1616	E16	77	10	100
	BAEH1618	E18	77	10	100
	BAEH1620	E20	77	5	80

Hand Sockets, Bit Sockets & Accessories

1/2" DR. Damaged Bolt Remover Sockets

Made of Chrome Molybdenum Alloy Steel
For easy removal of rounded-off, rusted tight or painted-over bolts and nuts

CR-MO DIN3120



A unique, reverse spiral flute design provides a positive grip to remove rounded or damaged bolts and nuts



METRIC

Black Phosphate Finished

DRIVE	ITEM NO.	SIZE(mm)	L(mm)		
1/2" 12.7mm sq.	BAAK1610	10	34	20	320
	BAAK1611	11	34	20	320
	BAAK1612	12	34	20	320
	BAAK1613	13	34	20	320
	BAAK1614	14	34	15	240
	BAAK1615	15	34	15	240
	BAAK1616	16	34	15	240
	BAAK1617	17	34	15	240
	BAAK1618	18	34	10	160
	BAAK1619	19	34	10	160

9PCS

1/2" DR. Damaged Bolt Remover Socket Rail Set



Black Phosphate Finished

ITEM NO.	CONTENTS		
GAAG0903	9 BAAK1610~1619 10, 11, 12, 13, 14, 15, 16, 17, 19 mm	10 (SET)	

3/8" DR. Flexible Universal Sockets

CR-V ANSI / ASME 107.1 DIN3124



Satin Chrome Finished

ITEM NO.	SIZE(mm)	L(mm)		
BAAL1210	10	50	10	160
BAAL1211	11	51	10	160
BAAL1212	12	51	10	160
BAAL1213	13	52	10	160
BAAL1214	14	52	10	160
BAAL1215	15	55	10	160
BAAL1216	16	55	10	160
BAAL1217	17	56	10	100
BAAL1218	18	56	10	100
BAAL1219	19	58	10	100

ITEM NO.	SIZE(inch)	L(mm)		
BBAL1212	3/8	50	10	160
BBAL1214	7/16	51	10	160
BBAL1216	1/2	52	10	160
BBAL1218	9/16	52	10	160
BBAL1220	5/8	55	10	160
BBAL1222	11/16	56	10	100
BBAL1224	3/4	58	10	100

10PCS

3/8" DR. Flexible Universal Socket Rail Set



Satin Chrome Finished

ITEM NO.	CONTENTS		
GAAG1004	10 BAAL1210~1219 10, 11, 12, 13, 14, 15, 16, 17, 18, 19 mm	10 (SET)	

7PCS

3/8" DR. Flexible Universal Socket Rail Set



Satin Chrome Finished

ITEM NO.	CONTENTS		
GBAG0701	7 BBAL1212~1224 3/8", 7/16", 1/2", 9/16", 5/8", 11/16", 3/4"	15 (SET)	



TOPTUL
Flexible Universal Sockets

Ratchet Unit

CR-MO DIN 3120



72 Gears / Satin Chrome Finished

DRIVE	ITEM NO. Satin	L(mm)		
3/8"	CAQA1255	56	10	80
1/2"	CAQA1660	60	10	80

Adapter

CR-V DIN3123



Mirror / Satin Chrome Finished

ITEM NO.	DRIVE	L(mm)		
CAEA0812	○ 1/4"(F) x ■ 3/8"(M)	26	10	180
CAEA1208	○ 3/8"(F) x ■ 1/4"(M)	25	10	180
CAEA1216	○ 3/8"(F) x ■ 1/2"(M)	36	10	180
CAEA1612	○ 1/2"(F) x ■ 3/8"(M)	36	10	180

Satin Chrome Finished

ITEM NO.	DRIVE	L(mm)		
CAEA1624	○ 1/2"(F) x ■ 3/4"(M)	51	10	80
CAEA2416	○ 3/4"(F) x ■ 1/2"(M)	57	10	80

Magnetic Spark Plug Sockets

CR-V DIN3120



Magnetic

Dual Finished

DRIVE	ITEM NO. Dual	SIZE(mm)	L(mm)		
3/8"	BAAT1216	16	65	10	160
	BAAT1221	21	67	10	80
1/2"	BAAT1616	16	65	10	160
	BAAT1621	21	67	10	80

Universal Joint

CR-V DIN3123



Mirror / Satin Chrome Finished

DRIVE	ITEM NO.	L(mm)		
1/4"	CAHA0840	39	10	180
3/8"	CAHA1254	54	10	160
1/2"	CAHA1678	71	10	100

Satin Chrome Finished

DRIVE	ITEM NO.	L(mm)		
3/4"	CAHA24A0	111	5	40

3/8" DR. Spark Plug Socket (Leaf Spring)

CR-V DIN 3120



Special leaf spring design to retain/clip the spark plug

Satin Finished

DRIVE	ITEM NO. Satin	SIZE(mm)	L(mm)		
3/8"	BAAX1214	14	63	10	160

Magnetic Aluminum Socket Rail

Portable socket holder
Anodized aluminum rail construction
Super strong magnet for solid placement
Holds both standard and deep sockets
Removable fasteners



▶ 1/4" Drive



▶ 3/8" Drive



▶ 1/2" Drive

ITEM NO.	DRIVE	Fastener	L(mm)		
PBKB2R2414	1/4"	14 pcs	240	6	72
PBKB3R2412	3/8"	12 pcs	240	6	72
PBKB4R2410	1/2"	10 pcs	240	6	72



Hand Sockets, Bit Sockets & Accessories

Standard

Star Bit Sockets

CR-V+S2



DRIVE	ITEM NO. Satin	SIZE	L(mm)		
1/4" 6.35mm sq.	BCFA0808	T8	37	30	540
	BCFA0810	T10	37	30	540
	BCFA0815	T15	37	30	540
	BCFA0820	T20	37	30	540
	BCFA0825	T25	37	30	540
	BCFA0827	T27	37	30	540
	BCFA0830	T30	37	30	540
	BCFA0840	T40	37	20	360
3/8" 9.5mm sq.	BCFA1215	T15	48	10	180
	BCFA1220	T20	48	10	180
	BCFA1225	T25	48	10	180
	BCFA1227	T27	48	10	180
	BCFA1230	T30	48	10	180
	BCFA1240	T40	48	10	180
	BCFA1245	T45	48	10	180
	BCFA1250	T50	48	10	180
1/2" 12.7mm sq.	BCFA1620	T20	55	10	160
	BCFA1625	T25	55	10	160
	BCFA1627	T27	55	10	160
	BCFA1630	T30	55	10	160
	BCFA1640	T40	55	10	160
	BCFA1645	T45	55	10	160
	BCFA1650	T50	55	10	160
	BCFA1655	T55	55	10	160
BCFA1660	T60	55	10	160	
BCFA1670	T70	55	10	160	

Spline Bit Sockets

CR-V+S2 DIN 2324



DRIVE	ITEM NO. Satin	SIZE	L(mm)		
1/2" 12.7mm sq.	BCHA1605	M5	55	15	240
	BCHA1606	M6	55	15	240
	BCHA1608	M8	55	15	240
	BCHA1610	M10	55	15	240
	BCHA1612	M12	55	15	240
	BCHA1614	M14	55	10	100
	BCHA1616	M16	55	10	100

Pentacle Bit Sockets

CR-V+S2



DRIVE	ITEM NO. Satin	SIZE	L(mm)		
1/4" 6.35mm sq.	BCNA0808	T8	37	30	360
	BCNA0810	T10	37	30	360
	BCNA0815	T15	37	30	360
	BCNA0820	T20	37	30	360
	BCNA0825	T25	37	30	360
	BCNA0827	T27	37	30	360
	BCNA0830	T30	37	30	360
	BCNA0840	T40	37	30	360
1/2" 12.7mm sq.	BCNA1620	T20	55	10	160
	BCNA1625	T25	55	10	160
	BCNA1627	T27	55	10	160
	BCNA1630	T30	55	10	160
	BCNA1640	T40	55	10	160
	BCNA1645	T45	55	10	160
	BCNA1650	T50	55	10	160
	BCNA1655	T55	55	10	160

Star Tamperproof Bit Sockets

CR-V+S2



DRIVE	ITEM NO. Satin	SIZE	L(mm)		
1/4" 6.35mm sq.	BCLA0808	T8	37	30	360
	BCLA0810	T10	37	30	360
	BCLA0815	T15	37	30	360
	BCLA0820	T20	37	30	360
	BCLA0825	T25	37	30	360
	BCLA0827	T27	37	30	360
	BCLA0830	T30	37	30	360
	BCLA0840	T40	37	30	360
1/2" 12.7mm sq.	BCLA1620	T20	55	10	160
	BCLA1625	T25	55	10	160
	BCLA1627	T27	55	10	160
	BCLA1630	T30	55	10	160
	BCLA1640	T40	55	10	160
	BCLA1645	T45	55	10	160
	BCLA1650	T50	55	10	160
	BCLA1655	T55	55	10	160
BCLA1660	T60	55	10	160	

Ribe Bit Sockets

CR-V+S2



DRIVE	ITEM NO. Satin	SIZE	L(mm)		
1/2" 12.7mm sq.	BCQA1605	M5	55	15	240
	BCQA1606	M6	55	15	240
	BCQA1607	M7	55	15	240
	BCQA1608	M8	55	15	240
	BCQA1609	M9	55	15	240
	BCQA1610	M10	55	15	240
	BCQA1612	M12	55	15	240
	BCQA1613	M13	55	10	100
	BCQA1614	M14	55	10	100
	BCQA1616	M16	55	10	100

Standard

Hex Bit Sockets

CR-V+S2 DIN 7422



DRIVE	ITEM NO. Satin	SIZE(mm)	L(mm)		
1/4" 6.35mm sq.	BCDA082E	2.5	37	30	540
	BCDA0803	3	37	30	540
	BCDA0804	4	37	30	540
	BCDA0805	5	37	30	540
	BCDA0806	6	37	30	540
	BCDA0807	7	37	30	540
	BCDA0808	8	37	30	540
	3/8" 9.5mm sq.	BCDA1203	3	48	10
BCDA1204		4	48	10	180
BCDA1205		5	48	10	180
BCDA1206		6	48	10	180
BCDA1207		7	48	10	180
BCDA1208		8	48	10	180
BCDA1210		10	48	10	180
1/2" 12.7mm sq.		BCDA1604	4	55	15
	BCDA1605	5	55	15	240
	BCDA1606	6	55	15	240
	BCDA1607	7	55	15	240
	BCDA1608	8	55	15	240
	BCDA1610	10	55	10	160
	BCDA1612	12	55	10	160
	BCDA1614	14	55	10	100
	BCDA1617	17	55	10	100
	BCDA1619	19	55	10	100

DRIVE	ITEM NO. Satin	SIZE(inch)	L(mm)		
1/4" 6.35mm sq.	BDDA0804	1/8	37	30	540
	BDDA0805	5/32	37	30	540
	BDDA0806	3/16	37	30	540
	BDDA0807	7/32	37	30	540
	BDDA0808	1/4	37	30	540
3/8" 9.5mm sq.	BDDA1204	1/8	48	10	180
	BDDA1205	5/32	48	10	180
	BDDA1206	3/16	48	10	180
	BDDA1207	7/32	48	10	180
	BDDA1208	1/4	48	10	180
1/2" 12.7mm sq.	BDDA1210	5/16	48	10	180
	BDDA1212	3/8	48	10	180
	BDDA1608	1/4	55	15	240
	BDDA1610	5/16	55	15	240
	BDDA1612	3/8	55	10	160
	BDDA1614	7/16	55	10	160
	BDDA1616	1/2	55	10	100
	BDDA1618	9/16	55	10	100
	BDDA1620	5/8	55	10	100
	BDDA1624	3/4	55	10	100

Pozi Bit Sockets

CR-V+S2 DIN ISO 8764-1



DRIVE	ITEM NO. Satin	SIZE	L(mm)		
1/4" 6.35mm sq.	BCBA08P0	PZ0	37	30	540
	BCBA08P1	PZ1	37	30	540
	BCBA08P2	PZ2	37	30	540
	BCBA08P3	PZ3	37	30	540
3/8" 9.5mm sq.	BCBA12P1	PZ1	48	10	180
	BCBA12P2	PZ2	48	10	180
	BCBA12P3	PZ3	48	10	180
	BCBA12P4	PZ4	48	10	180

Slotted Bit Sockets

CR-V+S2 DIN ISO 2380-1



DRIVE	ITEM NO. Satin	SIZE(mm)	L(mm)		
1/4" 6.35mm sq.	BCCA0803	3	37	30	540
	BCCA0804	4	37	30	540
	BCCA084E	4.5	37	30	540
	BCCA085E	5.5	37	30	540
	BCCA086E	6.5	37	30	540
	BCCA0808	8	37	30	540
	BCCA125E	5.5	48	10	180
	BCCA126E	6.5	48	10	180
3/8" 9.5mm sq.	BCCA1208	8	48	10	180
	BCCA1210	10	48	10	180
	BCCA1608	8	55	10	160
	BCCA1610	10	55	10	160
1/2" 12.7mm sq.	BCCA1612	12	55	10	160
	BCCA1614	14	55	10	160
	BCCA1616	16	55	10	160

Phillips Bit Sockets

CR-V+S2 DIN ISO 8764-1



DRIVE	ITEM NO. Satin	SIZE	L(mm)		
1/4" 6.35mm sq.	BCAA08P0	PH0	37	30	540
	BCAA08P1	PH1	37	30	540
	BCAA08P2	PH2	37	30	540
	BCAA08P3	PH3	37	30	540
3/8" 9.5mm sq.	BCAA08P4	PH4	37	30	540
	BCAA12P1	PH1	48	10	180
	BCAA12P2	PH2	48	10	180
	BCAA12P3	PH3	48	10	180
1/2" 12.7mm sq.	BCAA12P4	PH4	48	10	180
	BCAA16P2	PH2	55	10	160
	BCAA16P3	PH3	55	10	160
	BCAA16P4	PH4	55	10	160

10PCS

1/2" DR. Star Bit Socket Rail Set



ITEM NO. Satin	CONTENTS	
GAAG1006	10 BCFA1620-1670 1/2" Dr. Star Bit Sockets (55mmL) T20, T25, T27, T30, T40, T45, T50, T55, T60, T70	10 (SET)

Hand Sockets, Bit Sockets & Accessories

Standard

7PCS

3/8" DR. Hex Bit Socket Rail Set



ITEM NO.	CONTENTS	
Satin		15 (SET)
GAAG0702 7	BCDA1203~1210 3/8" Dr. Hex Bit Sockets (48mmL) 3, 4, 5, 6, 7, 8, 10 mm	

Satin Chrome Finished

10PCS

1/2" DR. Hex Bit Socket Rail Set



ITEM NO.	CONTENTS	
Satin		10 (SET)
GAAG1005 10	BCDA1604~1619 1/2" Dr. Hex Bit Sockets (55mmL) 4, 5, 6, 7, 8, 10, 12, 14, 17, 19 mm	

Satin Chrome Finished

7PCS

3/8" DR. Hex Bit Socket Rail Set



ITEM NO.	CONTENTS	
Satin		10 (SET)
GBAG0702 7	BDDA1204~1212 3/8" Dr. Hex Bit Sockets (48mmL) 1/8", 5/32", 3/16", 7/32", 1/4", 5/16", 3/8"	

Satin Chrome Finished

8PCS

1/2" DR. Hex Bit Socket Rail Set



ITEM NO.	CONTENTS	
Satin		10 (SET)
GBAG0801 8	BDDA1608~1624 1/2" Dr. Hex Bit Sockets (55mmL) 1/4", 5/16", 3/8", 7/16", 1/2", 9/16", 5/8", 3/4"	

Satin Chrome Finished

8PCS

1/4" DR. Star Bit Socket Rail Set



ITEM NO.	CONTENTS	
Satin		15 (SET)
GAAG0808 8	BCFA0808-0840 1/4" Dr. Star Bit Sockets (37mmL) T8, T10, T15, T20, T25, T27, T30, T40	

Satin Chrome Finished

8PCS

3/8" DR. Star Bit Socket Rail Set



ITEM NO.	CONTENTS	
Satin		15 (SET)
GAAG0804 8	BCFA1215~1250 3/8" Dr. Star Bit Sockets (48mmL) T15, T20, T25, T27, T30, T40, T45, T50	

Satin Chrome Finished

Standard

8PCS
1/4" DR. Star Tamperproof Bit Socket Rail Set



 Satin Chrome Finished

ITEM NO.	CONTENTS
Satin	15 (SET)

GAAG0809 8 BCLA0808-0840
1/4" Dr. Star Tamperproof Bit Sockets (37mmL)
T8, T10, T15, T20, T25, T27, T30, T40

8PCS
1/4" DR. Pentacle Bit Socket Rail Set



 Satin Chrome Finished

ITEM NO.	CONTENTS
Satin	15 (SET)

GAAG0805 8 BCNA0808-0840
1/4 " Dr. Pentacle Bit Sockets (37mmL)
T8, T10, T15, T20, T25, T27, T30, T40

7PCS
1/2" DR. Spline Bit Socket Rail Set



 Satin Chrome Finished

ITEM NO.	CONTENTS
Satin	8 (SET)

GAAG0703 7 BCHA1605-1616
1/2" Dr. Spline Bit Sockets (55mmL)
M5, M6, M8, M10, M12, M14, M16

8PCS
1/2" DR. Pentacle Bit Socket Rail Set

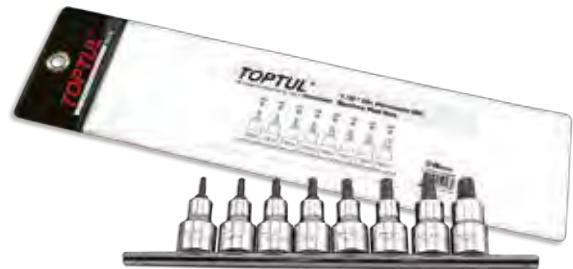

 Satin Chrome Finished

ITEM NO.	CONTENTS
Satin	10 (SET)

GAAG0806 8 BCNA1620-1655
1/2" Dr. Pentacle Bit Sockets (55mmL)
T20, T25, T27, T30, T40, T45, T50, T55

10PCS
1/2" DR. Ribe Bit Socket Rail Set



 Satin Chrome Finished

ITEM NO.	CONTENTS
Satin	10 (SET)

GAAG1002 10 BCQA1605-1616
1/2 " Dr. Ribe Bit Sockets (55mmL)
M5, M6, M7, M8, M9, M10, M12, M13, M14, M16

TOPTUL
Standard Bit Sockets



Hand Sockets, Bit Sockets & Accessories

Long

Hex Bit Sockets

CR-V+S2 DIN 7422



DRIVE	ITEM NO. Satin	SIZE(mm)	L(mm)	Satin Chrome Finished	
 1/2" 12.7mm sq.	BCEA1605	5	100	10	160
	BCEA1606	6	100	10	160
	BCEA1607	7	100	10	160
	BCEA1608	8	100	10	160

Star Bit Sockets

CR-V+S2



DRIVE	ITEM NO. Satin	SIZE	L(mm)	Satin Chrome Finished	
 1/2" 12.7mm sq.	BCXA1620	T20	80	20	160
	BCXA1625	T25	80	20	160
	BCXA1627	T27	80	20	160
	BCXA1630	T30	80	20	160
	BCXA1640	T40	80	20	160
	BCXA1645	T45	80	20	160
	BCXA1650	T50	80	20	160
	BCXA1655	T55	80	20	160
	BCXA1660	T60	80	20	160

9PCS

1/2" DR. Long Hex Bit Socket Rail Set



ITEM NO. Satin	CONTENTS	Satin Chrome Finished
GAAG0902	BCWA1604-1617 1/2" Dr. Long Hex Bit Sockets (80mmL) 4, 5, 6, 7, 8, 10, 12, 14, 17 mm	10 (SET)

8PCS

1/2" DR. Long Pentacle Bit Socket Rail Set



ITEM NO. Satin	CONTENTS	Satin Chrome Finished
GAAG0807	BCOA1620-1655 1/2" Dr. Long Pentacle Bit Sockets (100mmL) T20, T25, T27, T30, T40, T45, T50, T55	10 (SET)

10PCS

1/2" DR. Long Ribe Bit Socket Rail Set

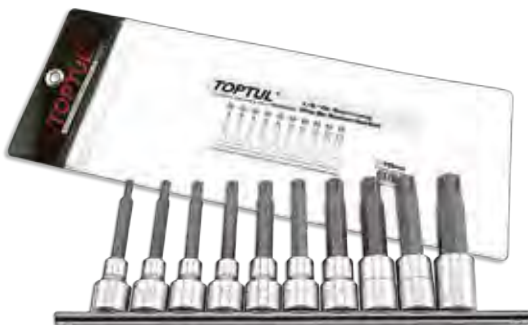

ITEM NO. Satin	CONTENTS	Satin Chrome Finished
GAAG1003	BCRA1605-1616 1/2" Dr. Long Ribe Bit Sockets (100mmL) M5, M6, M7, M8, M9, M10, M12, M13, M14, M16	8 (SET)



TOPTUL
Long & Extra Long
Bit Sockets



**19.5 MM
SHORT LENGTH**

**12.9 MM
DIAMETER**



One-Piece Stubby Bit Sockets

Made of high quality SNCM+V Alloy Steel
Precision machined one-piece construction
High torque performance

Manganese phosphate finished
Stubby model for working in confined spaces
Hand-operated tool

One-Piece Stubby Phillips Bit Sockets

(SNCM+V)



DRIVE	ITEM NO.	SIZE	L(mm)	D(mm)		
 1/4" 6.35mm sq.	BCAB08P1	PH1	19.5	12.9	50	900
	BCAB08P2	PH2	19.5	12.9	50	900
	BCAB08P3	PH3	19.5	12.9	50	900
	Black Phosphate Finished					

One-Piece Stubby Slotted Bit Sockets

(SNCM+V)



DRIVE	ITEM NO.	SIZE(mm)	L(mm)	D(mm)		
 1/4" 6.35mm sq.	BCCB0803	3	19.5	12.9	50	900
	BCCB084E	4.5	19.5	12.9	50	900
	BCCB086E	6.5	19.5	12.9	50	900
	BCCB0808	8	19.5	12.9	50	900
Black Phosphate Finished						

One-Piece Stubby Hex Bit Sockets

(SNCM+V)



DRIVE	ITEM NO.	SIZE(mm)	L(mm)	D(mm)		
 1/4" 6.35mm sq.	BCDB0803	3	19.5	12.9	50	900
	BCDB0804	4	19.5	12.9	50	900
	BCDB0805	5	19.5	12.9	50	900
	BCDB0806	6	19.5	12.9	50	900
	BCDB0807	7	19.5	12.9	50	900
	BCDB0808	8	19.5	12.9	50	900
	Black Phosphate Finished					

One-Piece Stubby Star Bit Sockets

(SNCM+V)



DRIVE	ITEM NO.	SIZE	L(mm)	D(mm)		
 1/4" 6.35mm sq.	BCFB0808	T8	19.5	12.9	50	900
	BCFB0810	T10	19.5	12.9	50	900
	BCFB0815	T15	19.5	12.9	50	900
	BCFB0820	T20	19.5	12.9	50	900
	BCFB0825	T25	19.5	12.9	50	900
	BCFB0827	T27	19.5	12.9	50	900
	BCFB0830	T30	19.5	12.9	50	900
	BCFB0840	T40	19.5	12.9	50	900
Black Phosphate Finished						

Hand Sockets, Bit Sockets & Accessories

Mini Reversible Ratchet & Bit Ratchet Handle

1/4" DR. Flexible Head Mini Reversible Ratchet Handle with Quick Release

-NEW
DIN 3122

- Chrome Vanadium Steel Material
- Fine 60 teeth ratcheting mechanism with hard-wearing construction
- Low back-torque design allows faster turning and removal of fastener
- Flex head for accessing hard to reach fasteners
- Anti-slip bi-component PP+TPR plastic soft grip handle
- Ideal for use in confined spaces



60 Gears / Mirror Finished

DRIVE	ITEM NO. Mirror	L(mm)		
1/4"	CJHU0811	113	10	120

1/4" (H) Flexible Head Mini Reversible Bit Ratchet Handle

-NEW

- Chrome Vanadium Steel Material
- Fine 60 teeth ratcheting mechanism with hard-wearing construction
- Low back-torque design allows faster turning and removal of fastener
- Flex head for accessing hard to reach fastener
- Anti-slip bi-component PP+TPR plastic soft grip handle
- Ideal for use in confined spaces



60 Gears / Satin Chrome Finished

HEX	ITEM NO. Satin	L(mm)		
1/4"	CJHV0811	113	10	120

Mini Reversible Ratchet Handle with Quick Release

DIN 3122

- Chrome Vanadium Steel Material
- Fine 60 teeth ratcheting mechanism with hard-wearing construction
- Low back-torque design allows faster turning and removal of fastener
- Curved handle for easy and comfort grip
- Ideal for use in confined spaces



60 Gears / Mirror Finished

DRIVE	ITEM NO. Mirror	L(mm)		
1/4"	CHDU0809	90	15	180

Mini Reversible Bit Ratchet Handle

- Chrome Vanadium Steel Material
- Fine 60 teeth ratcheting mechanism with hard-wearing construction
- Low back-torque design allows faster turning and removal of fastener
- Curved handle for easy and comfort grip
- Ideal for use in confined spaces



60 Gears / Mirror Finished

HEX	ITEM NO. Mirror	L(mm)		
1/4"	CHDV0809	90	15	180

1/4" DR. Flexible Head Mini Reversible Ratchet Handle with Quick Release

DIN 3122

- Chrome Vanadium Steel Material
- Fine 60 teeth ratcheting mechanism with hard-wearing construction
- Low back-torque design allows faster turning and removal of fastener
- Flex head for accessing hard to reach fasteners
- Curved handle for easy and comfort grip
- Ideal for use in confined spaces



60 Gears / Mirror Finished

DRIVE	ITEM NO. Mirror	L(mm)		
1/4"	CHKU0811	105	10	120

1/4" (H) Flexible Head Mini Reversible Bit Ratchet Handle

- Chrome Vanadium Steel Material
- Fine 60 teeth ratcheting mechanism with hard-wearing construction
- Low back-torque design allows faster turning and removal of fastener
- Flex head for accessing hard to reach fasteners
- Curved handle for easy and comfort grip
- Ideal for use in confined spaces



60 Gears / Mirror Finished

HEX	ITEM NO. Mirror	L(mm)		
1/4"	CHKV0811	105	10	120

1/4" DR. Reversible Ratchet Handle with Quick Release

- Anti-slip grip handle design
- Improved PP+soft PP material plastic handle for better anti-alkali, acid and corrosion effect

DIN 3122

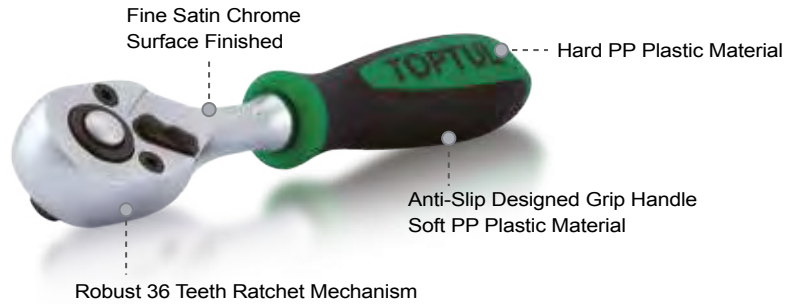

Stubby Swivel-Head Ratchet with Bit Drives

DIN 3122



72 Gears / Satin Chrome Finished

DRIVE	ITEM NO. Satin	L(mm)		
3/8" x 1/4" (H)	CJOM1216	160	2	32



36 Gears / Satin Chrome Finished

DRIVE	ITEM NO. Satin	L(mm)		
1/4"	S135	135	10	100

Stubby Swivel-Head Ratchet

DIN 3122



72 Gears / Satin Chrome Finished

DRIVE	ITEM NO. Satin	L(mm)		
1/2"	CJNM1616	160	2	32

Stubby Reversible Ratchet Handle with Quick Release

DIN 3122



45 Gears / Satin Chrome Finished

DRIVE	ITEM NO. Satin	L(mm)		
1/4"	CJDI0812	115	10	80
3/8"	CJDI1215	145	5	40

Stubby Swivel-Head Ratchet with Dual Drives

DIN 3122



72 Gears / Satin Chrome Finished

DRIVE	ITEM NO. Satin	L(mm)		
3/8" x 1/4"	CJMM1216	160	2	32
1/2" x 1/4"	CJMM1616	160	2	32

Stubby Reversible Ratchet Handle with Quick Release

DIN 3122



45 Gears / Mirror Polished

DRIVE	ITEM NO. Mirror	L(mm)		
1/4"	CHDI0809	90	10	80
3/8"	CHDI1211	110	5	40
1/2"	CHDI1613	130	5	40

Hand Sockets, Bit Sockets & Accessories

TOPTUL HIGH PERFORMANCE RATCHETS



Reversible Ratchet Handle with Quick Release

DIN 3122



36 Gears / Satin Chrome Finished

DRIVE	ITEM NO. Satin	L(mm)		
1/4"	CJBG0815	150	10	100
3/8"	CJBG1220	200	5	40
1/2"	CJBG1627	270	5	30

Reversible Ratchet Handle with Quick Release

DIN 3122



36 Gears / Mirror Polished

DRIVE	ITEM NO. Mirror	L(mm)		
1/4"	CHAG0813	131	10	100
3/8"	CHAG1218	180	5	40
1/2"	CHAG1626	255	5	30

Gearless Reversible Ratchet Handle with Quick Release

DIN 3122



Mirror Polished

DRIVE	ITEM NO. Mirror	L(mm)		
1/4"	CJBT0816	155	10	100
3/8"	CJBT1220	200	5	40
1/2"	CJBT1627	265	5	30

Reversible Ratchet Handle with Quick Release

DIN 3122



45 Gears / Satin Chrome Finished

DRIVE	ITEM NO. Satin	L(mm)		
1/4"	CJPI0815	145	10	100
3/8"	CJPI1220	200	5	40
1/2"	CJPI1627	265	5	30

Reversible Ratchet Handle with Quick Release

DIN 3122



72 Gears / Satin Chrome Finished

DRIVE	ITEM NO. Satin	L(mm)		
1/4"	CJBM0815	145	10	100
3/8"	CJBM1220	200	5	40
1/2"	CJBM1627	265	5	30

Curved Reversible Compact-Head Ratchet Handle with Quick Release

DIN 3122



72 Gears / Satin Chrome Finished

DRIVE	ITEM NO. Satin	L(mm)		
1/4"	CHJM0815	145	10	100
3/8"	CHJM1220	200	5	40
1/2"	CHJM1625	250	5	30

Compact Head Reversible Ratchet Handle with Quick Release

DIN 3122



60 Gears / Satin Chrome Finished

DRIVE	ITEM NO. Satin	L(mm)		
1/4"	CJSU0815	145	10	100
3/8"	CJSU1220	202	5	40
1/2"	CJSU1626	262	5	30

Reversible Ratchet Handle with Quick Release

DIN 3122



72 Gears / Satin Chrome Finished

DRIVE	ITEM NO. Satin	L(mm)		
1/4"	CJRM0815	145	10	100
3/8"	CJRM1220	202	5	40
1/2"	CJRM1626	262	5	30

Flexible Reversible Ratchet Handle with Quick Release

DIN 3122



72 Gears / Satin Chrome Finished

DRIVE	ITEM NO. Satin	L(mm)		
1/4"	CJHM0814	140	10	100
3/8"	CJHM1228	280	5	40
1/2"	CJHM1631	310	5	30

Extra Long Reversible Ratchet Handle with Quick Release

DIN 3122



48 Gears / Satin Chrome Finished

DRIVE	ITEM NO. Satin	L(mm)		
1/4"	CJCK0819	195	5	60
3/8"	CJCK1228	320	5	30
1/2"	CJCK1640	400	3	18

Swivel Head Reversible Ratchet Handle

DIN 3122



72 Gears / Satin Chrome Finished

DRIVE	ITEM NO. Satin	L(mm)		
1/4"	CJLN0816	155	10	100
3/8"	CJLN1224	240	5	40
1/2"	CJLN1632	315	5	30

Reversible Ratchet Handle with Quick Release

DIN 3122



72 Gears / Mirror Polished

DRIVE	ITEM NO. Mirror	L(mm)		
1/4"	CHAM0813	130	10	100
3/8"	CHAM1220	198	5	40
1/2"	CHAM1625	250	5	30

Swivel Head Reversible Ratchet Handle

DIN 3122



72 Gears / Mirror Polished

DRIVE	ITEM NO. Mirror	L(mm)		
1/4"	CYAN0815	153	10	100
3/8"	CYAN1222	230	5	40
1/2"	CYAN1629	285	5	30

Super Long Flex-Head Ratchet Handle

DIN 3122



72 Gears / Satin Chrome Finished

DRIVE	ITEM NO. Satin	L(mm)		
1/4"	CJKN0818	180	5	60
1/2"	CJKN1643	430	2	12

Hand Sockets, Bit Sockets & Accessories

▣ Ratchet with Adjustable Handle



ITEM NO.	CONTENTS	6 (SET)
	1 CHAG1636	
	1/2" Dr. Reversible Ratchet Handle with Quick Release	
GBAE0201	1 COAI1633	
	1/2" Dr. Adjustable Handle (turn-lock) Design	

▣ Reversible Ratchet Handle with Quick Release

DIN 3122



DRIVE	ITEM NO.	L(inch)	2	8
3/4"	CHFS2451	20		

43 Gears / Satin Chrome Finished

▣ Reversible Ratchet with Adjustable Tube Handle (Quick-Release)

DIN 3122

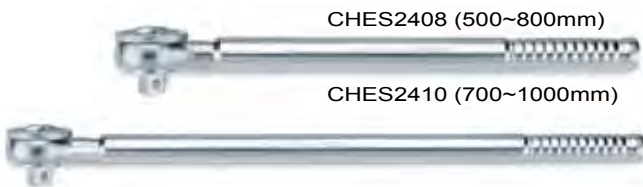

DRIVE	ITEM NO.	L(mm)	1	4
3/4"	CHES2408	500~800		
	CHES2410	700~1000		

43 Gears / Satin Chrome Finished

▣ Swivel Handle with Adjustable Tube Handle

(Quick-Release)

CR-V DIN 3122

CFDC2408 (500~800mm)



DRIVE	ITEM NO.	L(mm)	2	8
3/4"	CFDC2408	500~800		

Satin Chrome Finished

▣ Reversible Ratchet with Tube Handle (Quick-Release)

DIN 3122



DRIVE	ITEM NO.	L(inch)	3	6
3/4"	CHNC2420	20		

24 Gears / Dual Finished

▣ Reversible Ratchet with Tube Handle

DIN 3122



DRIVE	ITEM NO.	L(inch)	5	5
1"	CHND3226	26		

24 Gears / Dual Finished

▣ Reversible Ratchet with Tube Handle

DIN 3122



DRIVE	ITEM NO.	L(inch)	1	4
1"	CHNC3232	32		

24 Gears / Dual Finished

▣ Extra Long Swivel Handle

DIN 3122



DRIVE	ITEM NO.	L(inch)	5	30
3/8"	CFBC1215	15		
	CFBC1618	18		
1/2"	CFBC1624	24		
	CFBC1630	30		
3/4"	CFBC2440	40		
1"	CFBC3240	40		

Mirror Polished

▣ Swivel Handle

DIN 3122



DRIVE	ITEM NO.	L(inch)	10	80
1/4"	CFKA0806	6		
3/8"	CFKA1208	8		
	CFKA1210	10		
	CFKA1615	15		
1/2"	CFKA1618	18		
	CFKA1624	24		

Satin Chrome Finished

Sliding T-Handle

CR-V DIN 3122



Mirror / Satin Chrome Finished

DRIVE	ITEM NO.		L(mm)		
	Mirror	Satin			
1/4"	CTCK0811		115	15	240
3/8"	CTCK1220		200	5	40
1/2"	CTCK1625		250	5	40
	CTCK1630		305	5	40

Extension Bar

CR-V DIN 3123



Satin Chrome Finished

DRIVE	ITEM NO.		L(inch)		
	Mirror	Satin			
3/4"	CAAO2404		4	5	40
	CAAO2408		8	2	24
	CAAO2416		16	2	12
1"	CAAO3208		8	2	16
	CAAO3216		16	2	8

Extension Bar

CR-V DIN 3123



Satin Chrome Finished

DRIVE	ITEM NO.	L(inch)		
1/4"	CAAH0809	9	10	100

Extension Bar

CR-V DIN 3123



Extension Bar

CR-V DIN 3123



Mirror Polished

DRIVE	ITEM NO.		L(inch)		
	Mirror	Satin			
1/4"	CAAF0802		2	30	540
	CAAF0803		3	30	480
	CAAF0804		4	30	480
	CAAF0806		6	30	300
3/8"	CAAF1203		3	25	200
	CAAF1206		6	15	120
	CAAF1209		9	10	80
1/2"	CAAF1602		2	10	160
	CAAF1605		5	10	80
	CAAF1610		10	5	40

Mirror / Satin Chrome Finished

DRIVE	ITEM NO.		L(inch)		
	Mirror	Satin			
1/4"	CAAA0802		2	30	480
	CAAA0803		3	30	480
	CAAA0804		4	30	480
	CAAA0806		6	30	300
3/8"	CAAA1203		3	25	200
	CAAA1206		6	15	120
1/2"	CAAA1210		10	10	80
	CAAA1603		3	10	80
	CAAA1605		5	10	80
	CAAA1610		10	5	40

Extra Long Extension Bar

CR-V DIN 3123



Satin Chrome Finished

DRIVE	ITEM NO.	L(inch)		
1/2"	CAAJ1615	15	10	20
	CAAJ1624	24	10	20

Extension Bar with Quick Release

CR-V DIN 3123



The locked-on design mechanism adds to lock the socket in place. Sockets will not be dropped out or removed unless the quick-release mechanism is released.

Satin Chrome Finished

DRIVE	ITEM NO.	L(inch)		
3/4"	CABA2408	8	2	24
	CABA2416	16	2	12

Extra Long Flexible Extension Bar



Mirror Polished

DRIVE	ITEM NO.	L(inch)		
1/4"	CASA0818	18	10	60

Flexible Extension Bar



Mirror Polished

DRIVE	ITEM NO.	L(inch)		
1/4"	CASA0806	6	30	300

Hand Sockets, Bit Sockets & Accessories

Speed Brace

DIN 3122



DRIVE	ITEM NO.	L(mm)	Mirror Polished	
	Mirror			
1/4"	CADC0840	400	5	20
3/8"	CADC1240	400	5	20
1/2"	CADC1642	420	5	10

L-Handle with Adjustable Handle

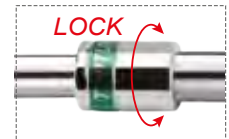

ITEM NO.	CONTENTS	
	6 (SET)	
GBAE0202	1 AFAS1612 1/2" Dr. L-Handle 1 COAI1633 1/2" Dr. Adjustable Handle (turn-lock) Design	

Adaptor



ITEM NO.	SIZE	L(mm)	Satin Chrome Finished	
Satin				
CAEC1216	3/8"(F) x 1/2"(M)	30	15	240

28PCS Professional Grade

1/2" DR. Flank Socket Set

1/2"



ITEM NO.	Special 1/2" Dr. socket set includes one LED lighting adaptor	
6PT	Satin GCA12802	4 (SET)
CONTENTS		
19 BAEA1608-1632	1/2" Dr. 6PT Flank Sockets 8, 9, 10, 11, 12, 13, 14, 15, 16, 17, 18, 19, 21, 22, 23, 24, 27, 30, 32 mm	
2 CAAA1605 & 1610	1/2" Dr. Extension Bar - 5" & 10" (L)	
1 CAHA1678	1/2" Dr. Universal Joint	
1 CJBG1627	1/2" Dr. 36 Teeth Reversible Ratchet Handle with Quick Release	
1 CTCK1625	1/2" Dr. Sliding T-Handle - 10" (L)	
1 CAED1616	1/2" Dr. LED Lighting Adaptor	
3 ALDA1205	LED Battery (LR44)	

BLOW CASE: W392 x D210 x H88 (mm)



Socket Sets & General Tool Sets Professional

Socket sets in 3/8", 1/2", 3/4" & 1" and general tool sets.

SOCKET SETS & GENERAL TOOL SETS

the choice of professionals



Socket Sets & General Tool Sets

6
PT

41
PCS

Professional Grade 1/4" DR. Flank Socket Set

- Bit holder rail swivel upwards for easy access
- EVA form + PP inner tool tray
- Robust, high quality and light weight ABS+TPU material plastic storage tool box

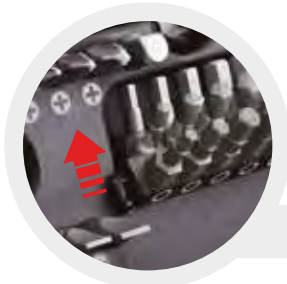

Swivel Mechanism Bit Holder

1/4"
DRIVE



Professional Grade 1/4" DR. Flank Socket Set

6PT Satin GADW4101

CONTENTS 20 (SET)

- 13 BAEA0804-0814
1/4" Dr. 6PT Flank Sockets
4, 4.5, 5, 5.5, 6, 7, 8, 9, 10, 11, 12, 13, 14 mm

- 2 CAAA0802 & 0804
1/4" Dr. Extension Bar - 2" & 4" (L)

- 1 CAHA0840
1/4" Dr. Universal Joint
- 1 CAIP0814
1/4" Dr. Spinner Handle

- 1 S135
1/4" Dr. 36 Teeth Reversible Ratchet Handle with Quick Release

- 1 FTAB0808
1/4" Dr. x 1/4" (H) Quick Change Bit Holder (25mmL)

- 1 FSKA0808
1/4" (H) x 1/4" Dr. Socket Adaptor (25mmL)

- 3 FSBA0801-0803
1/4" Hex Shank Phillips Insert Bits (25mmL)
PH1, PH2, PH3

- 3 FSCA0801-0803
1/4" Hex Shank Pozi Insert Bits (25mmL)
PZ1, PZ2, PZ3

- 3 FSAA0804E-0808
1/4" Hex Shank Slotted Insert Bits (25mmL)
4.5, 6.5, 8 mm

- 5 FSDA0803-0808
1/4" Hex Shank Hexagon Insert Bits (25mmL)
3, 4, 5, 6, 8 mm

- 7 FSGA0810-0840
1/4" Hex Shank Star Tamperproof Insert Bits (25mmL)
T10, T15, T20, T25, T27, T30, T40

PLASTIC BOX: W172 x D105 x H48 (mm)



6 SETS

1/4" DR. Mini Ratchet Socket & Bit Set W/Display Box

1/4"



NEW

6 SETS

1/4" DR. Mini Ratchet Socket & Bit Set W/Display Box

1/4"



Protective PC+ABS Plastic Box
EVA Form Inner Tool Tray
6 Sets Packed in Each Display Color Box



Protective PC+ABS Plastic Box
EVA Form Inner Tool Tray
6 Sets Packed in Each Display Color Box



ITEM NO.

6PT Satin **GABW4301S**

CONTENTS 4 (SET)

6 GABW4301
43PCS 1/4" DR. Mini Ratchet Socket & Bit Set

Per Set Contents:

- BAEA085E-0813**
1/4" Dr. 6PT Flank Sockets
5.5, 6, 7, 8, 10, 11, 12, 13 mm
- FSAA0804-0808**
1/4" Hex Shank Slotted Insert Bits
4, 5.5, 6.5, 8 mm
- FSBA0801-0803**
1/4" Hex Shank Phillips Insert Bits
PH1, PH2x2pcs, PH3
- FSCA0801-0803**
1/4" Hex Shank Pozi Insert Bits
PZ1, PZ2, PZ3
- FSDA0803-0808**
1/4" Hex Shank Hexagon Insert Bits
3, 4, 5, 6, 8 mm
- FSEA0810-0840**
1/4" Hex Shank Star Insert Bits
T10, T15, T20, T25, T27, T30, T40
- FSGA0810-0840**
1/4" Hex Shank Star Tamperproof Insert Bits
T10, T15, T20, T25, T27, T30, T40
- FSHA0802**
1/4" Hex Shank Square Insert Bits
SQ2
- FSKA0808**
1/4" (H) x 1/4" Dr. Socket Adapter
- FTDC0808**
1/4" x 1/4" Magnetic Power Bit Holder
- CAAA0802**
1/4" Dr. Extension Bar - 2" (L)
- CJHV0811**
1/4" (H) 60 Teeth Flexible Head Mini Reversible Bit Ratchet Handle

PLASTIC BOX: W133 x D97 x H39 (mm)

ITEM NO.

6PT Mirror **GABW4101S**

CONTENTS 4 (SET)

6 GABW4101
41PCS 1/4" DR. Mini Ratchet Socket & Bit Set

Per Set Contents:

- BAEA085E-0813**
1/4" Dr. 6PT Flank Sockets
5.5, 6, 7, 8, 10, 11, 12, 13 mm
- FSAA0804-086E**
1/4" Hex Shank Slotted Insert Bits
4, 5.5, 6.5 mm
- FSBA0801-0803**
1/4" Hex Shank Phillips Insert Bits
PH1, PH2x2pcs, PH3
- FSCA0801-0803**
1/4" Hex Shank Pozi Insert Bits
PZ1, PZ2, PZ3
- FSDA0803-0806**
1/4" Hex Shank Hexagon Insert Bits
3, 4, 5, 6 mm
- FSEA0810-0840**
1/4" Hex Shank Star Insert Bits
T10, T15, T20, T25, T27, T30, T40
- FSGA0810-0840**
1/4" Hex Shank Star Tamperproof Insert Bits
T10, T15, T20, T25, T27, T30, T40
- FSHA0801 & 0802**
1/4" Hex Shank Square Insert Bits
SQ1 & SQ2
- FTAB0808**
1/4" Dr. x 1/4" (H) Quick Change Bit Holder
- CAAA0803**
1/4" Dr. Extension Bar - 3" (L)
- CJHU0811**
1/4" Dr. 60 Teeth Flexible Head Mini Reversible Ratchet Handle with Quick Release

PLASTIC BOX: W133 x D97 x H39 (mm)

Socket Sets & General Tool Sets

13PCS

1/4" DR. Mini Ratchet Socket Set

1/4"



• 1/4" Square Drive Mini Ratchet, Fine 60 tooth ratcheting mechanism. Ideal for use in confined spaces. Low back-torque design enables fast operation. Curved ergonomic handle gives a comfortable grip. Manufactured from Chrome Vanadium Alloy Steel, Overall Length: 3-1/2"

ITEM NO.

6PT Mirror GABW1301

CONTENTS

30 (SET)

12 BAEA0804-0813

1/4" Dr. 6PT Flank Sockets
4, 4.5, 5, 5.5, 6, 7, 8, 9, 10, 11, 12, 13 mm

1 CHDU0809

1/4" Dr. 60 Teeth Mini Reversible Ratchet Handle with Quick Release

PLASTIC BOX: W115 x D85 x H37 (mm)

30PCS

1/4" DR. Mini Ratchet Socket & Bit Set

1/4"



• 1/4" Hex Mini Bit Ratchet, Fine 60 tooth ratcheting mechanism. Ideal for use in confined spaces. Low back-torque design enables fast operation. Curved ergonomic handle gives a comfortable grip. Manufactured from Chrome Vanadium Alloy Steel, Overall Length: 3-1/2"

ITEM NO.

6PT Mirror GABW3001

CONTENTS

30 (SET)

7 BAEA0804-0808

1/4" Dr. 6PT Flank Sockets
4, 4.5, 5, 5.5, 6, 7, 8 mm

3 FSAA0804-086E

1/4" Hex Shank Slotted Insert Bits
4, 5, 5.5, 6.5 mm

4 FSBA0801-0803

1/4" Hex Shank Phillips Insert Bits
PH1, PH2x2pcs, PH3

3 FSCA0801-0803

1/4" Hex Shank Pozi Insert Bits
PZ1, PZ2, PZ3

4 FSDA0803-0806

1/4" Hex Shank Hexagon Insert Bits
3, 4, 5, 6 mm

7 FSEA0810-0840

1/4" Hex Shank Star Insert Bits
T10, T15, T20, T25, T27, T30, T40

1 FSKA0808

1/4" (H) x 1/4" Dr. Socket Adaptor

1 CHDV0809

1/4" (H) 60 Teeth Mini Reversible Bit Ratchet Handle

PLASTIC BOX: W115 x D85 x H37 (mm)

30PCS

1/4" DR. Mini Ratchet Socket & Bit Set

1/4"



ITEM NO.

6PT Mirror GABW3103

CONTENTS

30 (SET)

3 FSAA0804-086E

1/4" Hex Shank Slotted Insert Bits
4, 5.5, 6.5 mm

4 FSBA0801-0803

1/4" Hex Shank Phillips Insert Bits
PH1, PH2, PH3

3 FSCA0801-0803

1/4" Hex Shank Pozi Insert Bits
PZ1, PZ2, PZ3

4 FSDA0803-0806

1/4" Hex Shank Hexagon Insert Bits
3, 4, 5, 6 mm

7 FSEA0810-0840

1/4" Hex Shank Star Insert Bits
T10, T15, T20, T25, T27, T30, T40

7 FSGA0810-0840

1/4" Hex Shank Star Tamperproof Insert Bits
T10, T15, T20, T25, T27, T30, T40

2 FSHA0801-0802

1/4" Hex Shank Square Insert Bits
SQ1, SQ2

1 FSKA0808

1/4" (H) x 1/4" Dr. Socket Adaptor

1 CHDV0809

1/4" (H) 60 Teeth Mini Reversible Bit Ratchet Handle

PLASTIC BOX: W115 x D85 x H37 (mm)

41PCS Professional Grade

1/4" DR. Flank Socket Set

1/4"



ITEM NO.

6PT Satin GCAI4102

CONTENTS

10 (SET)

13 BAEA0804-0814

1/4" Dr. 6PT Flank Sockets
4, 4.5, 5, 5.5, 6, 7, 8, 9, 10, 11, 12, 13, 14 mm

3 FSAA0804-086E

1/4" Hex Shank Slotted Insert Bits
4, 5, 5.5, 6.5 mm

5 FSDA0803-0808

1/4" Hex Shank Hexagon Insert Bits
3, 4, 5, 6, 8 mm

6 FSEA0810-0840

1/4" Hex Shank Star Insert Bits
T10, T15, T20, T25, T30, T40

3 FSBA0801-0803

1/4" Hex Shank Phillips Insert Bits
PH1, PH2, PH3

3 FSCA0801-0803

1/4" Hex Shank Pozi Insert Bits
PZ1, PZ2, PZ3

1 CJBG0815

1/4" Dr. 36 Teeth Reversible Ratchet Handle with Quick Release

1 CAHA0840

1/4" Dr. Universal Joint

2 CAAA0802 & 0806

1/4" Dr. Extension Bar - 2" & 6" (L)

1 CAIP0816

1/4" Dr. Spinner Handle

1 CAGA1208

3/8" (F) x 1/4" (M) Dr. 3-Way Adaptor

1 CAEE0820

1/4" Dr. Magnetic Socket Pick-Up

1 FTAB0808

1/4" Dr. x 1/4" (H) Quick Change Bit Holder

BLOW CASE: W245 x D160 x H66 (mm)

24PCS Professional Grade

1/4" DR. Flank Socket Set

1/4"



ITEM NO.	6PT	Satin	GCAI2403
CONTENTS	📦 10 (SET)		
11 BAEA0804-0813	1/4" Dr. 6PT Flank Sockets 4, 5, 5.5, 6, 7, 8, 9, 10, 11, 12, 13 mm		
9 BAEE0805-0813	1/4" Dr. 6PT Flank Deep Sockets 5, 6, 7, 8, 9, 10, 11, 12, 13 mm		
1 CJBG0815	1/4" Dr. 36 Teeth Reversible Ratchet Handle with Quick Release		
1 CAIP0816	1/4" Dr. Spinner Handle		
2 CAAA0802 & 0806	1/4" Dr. Extension Bar - 2" & 6" (L)		
BLOW CASE: W245 x D160 x H66 (mm)			

51PCS Professional Grade

1/4" DR. Flank Socket Wrench Set

1/4"



ITEM NO.	6PT	Satin	GCAI5102
CONTENTS	📦 10 (SET)		
13 BAEA0804-0814	1/4" Dr. 6PT Flank Sockets 4, 4.5, 5, 5.5, 6, 7, 8, 9, 10, 11, 12, 13, 14 mm		
6 BCDA0803-0808	1/4" Dr. Hex Bit Sockets 3, 4, 5, 6, 7, 8 mm		
3 BCCA0804-086E	1/4" Dr. Slotted Bit Sockets 4, 5.5, 6.5 mm		
3 BCAA08P1-08P3	1/4" Dr. Phillips Bit Sockets PH1, PH2, PH3		
3 BCBA08P1-08P3	1/4" Dr. Pozi Bit Sockets PZ1, PZ2, PZ3		
7 BCFA0810-0840	1/4" Dr. Star Bit Sockets T10, T15, T20, T25, T27, T30, T40		
1 CASA0806	1/4" Dr. Flexible Extension Bar - 6" (L)		
1 CJBG0815	1/4" Dr. 36 Teeth Reversible Ratchet Handle with Quick Release		
1 CAIP0816	1/4" Dr. Spinner Handle		
1 CAHA0840	1/4" Dr. Universal Joint		
2 CAAA0802 & 0804	1/4" Dr. Extension Bar - 2" & 4" (L)		
1 CTCK0811	1/4" Dr. Sliding T-Handle		
9 GAAL0910	Short Type Hex Key Wrench Set 1.5, 2, 2.5, 3, 4, 5, 6, 8, 10 mm		
BLOW CASE: W245 x D160 x H66 (mm)			

46PCS Professional Grade

1/4" DR. Flank Socket Set

1/4"



ITEM NO.	6PT	Satin	GCAI4601
CONTENTS	📦 10 (SET)		
11 BAEA0804-0813	1/4" Dr. 6PT Flank Sockets 4, 5, 5.5, 6, 7, 8, 9, 10, 11, 12, 13 mm		
9 BAEE0805-0813	1/4" Dr. 6PT Flank Deep Sockets 5, 6, 7, 8, 9, 10, 11, 12, 13 mm		
1 CJBG0815	1/4" Dr. 36 Teeth Reversible Ratchet Handle with Quick Release		
1 CAIP0816	1/4" Dr. Spinner Handle		
2 CAAA0802 & 0806	1/4" Dr. Extension Bar - 2" & 6" (L)		
6 BCDA0803-0808	1/4" Dr. Hex Bit Sockets 3, 4, 5, 6, 7, 8 mm		
3 BCCA0804-086E	1/4" Dr. Slotted Bit Sockets 4, 5.5, 6.5 mm		
3 BCAA08P1-08P3	1/4" Dr. Phillips Bit Sockets PH1, PH2, PH3		
3 BCBA08P1-08P3	1/4" Dr. Pozi Bit Sockets PZ1, PZ2, PZ3		
7 BCFA0810-0840	1/4" Dr. Star Bit Sockets T10, T15, T20, T25, T27, T30, T40		
BLOW CASE: W245 x D160 x H66 (mm)			

26PCS Professional Grade

3/8" DR. Flank Socket Set

3/8"



ITEM NO.	6PT	Satin	GCAI2601
CONTENTS	📦 10 (SET)		
14 BAEA1208-1224	3/8" Dr. 6PT Flank Sockets 8, 10, 11, 12, 13, 14, 15, 16, 17, 18, 19, 21, 22, 24 mm		
8 BAEE1208-1219	3/8" Dr. 6PT Flank Deep Sockets 8, 10, 11, 12, 13, 14, 17, 19 mm		
1 CJBG1220	3/8" Dr. 36 Teeth Reversible Ratchet Handle with Quick Release		
2 CAAA1203 & 1206	3/8" Dr. Extension Bar - 3" & 6" (L)		
1 CAHA1254	3/8" Dr. Universal Joint		
BLOW CASE: W245 x D160 x H66 (mm)			

Socket Sets & General Tool Sets

35PCS Professional Grade

3/8" DR. Flank Socket Set (METRIC & SAE)

3/8"



ITEM NO.	6PT	Mirror	GCAI3501
CONTENTS			4 (SET)
16 BAEA1206~1222			
3/8" Dr. 6PT Flank Sockets			
6, 7, 8, 9, 10, 11, 12, 13, 14, 15, 16, 17, 18, 19, 21, 22 mm			
11 BBEA1208~1228			
3/8" Dr. 6PT Flank Sockets			
1/4", 5/16", 3/8", 7/16", 1/2", 9/16", 5/8", 11/16", 3/4", 13/16", 7/8"			
2 CAAA1203 & 1206			
3/8" Dr. Extension Bar - 3" & 6" (L)			
1 CAHA1254			
3/8" Dr. Universal Joint			
1 CJBG1220			
3/8" Dr. 36 Teeth Reversible Ratchet Handle with Quick Release			
1 CTCK1220			
3/8" Dr. Sliding T-Handle			
1 CFKA1210			
3/8" Dr. Swivel Handle			
2 BAAT1216 & 1221			
3/8" Dr. Magnetic Spark Plug Socket - 16 & 21 mm			
BLOW CASE: W392 x D210 x H88 (mm)			

60PCS Professional Grade

3/8" DR. Flank Socket Set

3/8"



ITEM NO.	6PT	Satin	GCAI6001
CONTENTS			6 (SET)
18 BAEA1206~1224			
3/8" Dr. 6PT Flank Sockets			
6, 7, 8, 9, 10, 11, 12, 13, 14, 15, 16, 17, 18, 19, 20, 21, 22, 24 mm			
10 BAEE1208~1219			
3/8" Dr. 6PT Flank Deep Sockets			
8, 9, 10, 11, 12, 13, 14, 15, 17, 19 mm			
3 BCAA12P1~12P3			
3/8" Dr. Phillips Bit Sockets			
PH1, PH2, PH3			
3 BCBA12P1~12P3			
3/8" Dr. Pozi Bit Sockets			
PZ1, PZ2, PZ3			
3 BCCA125E~1208			
3/8" Dr. Slotted Bit Sockets			
5.5, 6.5, 8 mm			
7 BCDA1203~1210			
3/8" Dr. Hex Bit Sockets			
3, 4, 5, 6, 7, 8, 10 mm			
9 BCFA1215~1255			
3/8" Dr. Star Bit Sockets			
T15, T20, T25, T27, T30, T40, T45, T50, T55			
2 CAAA1203 & 1210			
3/8" Dr. Extension Bar - 3" & 10" (L)			
2 BAAR1216 & 1221			
3/8" Dr. Spark Plug Sockets - 16 & 21 mm			
1 CJBG1220			
3/8" Dr. 36 Teeth Reversible Ratchet Handle with Quick Release			
1 CAHA1254			
3/8" Dr. Universal Joint			
1 CAGA1612			
1/2"(F) X 3/8"(M) Dr. 3-Way Adaptor			
BLOW CASE: W300 x D220 x H70 (mm)			

31PCS Professional Grade

1/2" DR. Flank Socket Set

1/2"



ITEM NO.	6PT	Satin	GAAI3104
CONTENTS			3 (SET)
24 BAEA1608~1632			
1/2" Dr. 6PT Flank Sockets			
8, 9, 10, 11, 12, 13, 14, 15, 16, 17, 18, 19, 20, 21, 22, 23, 24, 25, 26, 27, 28, 29, 30, 32 mm			
2 CAAA1605 & 1610			
1/2" Dr. Extension Bar - 5" & 10" (L)			
1 CTCK1625			
1/2" Dr. Sliding T-Handle - 10" (L)			
1 CJBG1627			
1/2" Dr. 36 Teeth Reversible Ratchet Handle with Quick Release			
1 CAHA1678			
1/2" Dr. Universal Joint			
2 BAAT1616 & 1621			
1/2" Dr. Magnetic Spark Plug Sockets - 16 & 21 mm			
BLOW CASE: W478 x D234 x H100 (mm)			

55PCS Professional Grade

1/2" DR. Flank Socket Set

1/2"



ITEM NO.	6PT	Satin	GAAI5502
CONTENTS			3 (SET)
17 BAEA1610~1632			
1/2" Dr. 6PT Flank Sockets			
10, 11, 12, 13, 14, 15, 16, 17, 18, 19, 20, 21, 22, 24, 27, 30, 32 mm			
10 BAEE1610~1622			
1/2" Dr. 6PT Flank Deep Sockets			
10, 11, 12, 13, 14, 15, 16, 17, 19, 22 mm			
7 BCDA1604~1614			
1/2" Dr. Hex Bit Sockets			
4, 5, 6, 8, 10, 12, 14 mm			
3 BCCA1608~1612			
1/2" Dr. Slotted Bit Sockets			
8, 10, 12 mm			
3 BCAA16P2~16P4			
1/2" Dr. Phillips Bit Sockets			
PH2, PH3, PH4			
8 BCDA1620~1655			
1/2" Dr. Star Tamperproof Bit Sockets			
T20, T25, T27, T30, T40, T45, T50, T55			
1 CJBG1627			
1/2" Dr. 36 Teeth Reversible Ratchet Handle with Quick Release			
2 BAAT1616 & 1621			
1/2" Dr. Magnetic Spark Plug Sockets - 16 & 21 mm			
2 CAAA1605 & 1610			
1/2" Dr. Extension Bar - 5" & 10" (L)			
1 CAHA1678			
1/2" Dr. Universal Joint			
1 CAGA1216			
3/8" (F) x 1/2" (M) Dr. 3-Way Adaptor			
BLOW CASE: W478 x D234 x H100 (mm)			

42PCS Professional Grade
1/4" & 1/2" DR. Flank Socket Wrench Set

1/4"

1/2"



ITEM NO.

6PT	Satin	GAAI4201
CONTENTS  3 (SET)		
10 BAEA0805-0813 1/4" Dr. 6PT Flank Sockets 5, 5.5, 6, 7, 8, 9, 10, 11, 12, 13 mm		
13 BAEA1610-1624 1/2" Dr. 6PT Flank Sockets 10, 11, 12, 13, 14, 15, 16, 17, 18, 19, 21, 22, 24 mm		
1 CAAA0804 1/4" Dr. Extension Bar - 4" (L)		
2 CAAA1605 & 1610 1/2" Dr. Extension Bar - 5" & 10" (L)		
2 CAHA0840 & 1678 1/4" & 1/2" Dr. Universal Joint		
2 CJBG0815 & 1627 1/4" & 1/2" Dr. 36 Teeth Reversible Ratchet Handle with Quick Release		
1 CAGA1216 3/8" (F) x 1/2" (M) Dr. 3-Way Adaptor		
11 AAEX0808-2222 15° Offset Hi-Performance Combination Wrenches 8, 9, 10, 11, 12, 13, 14, 17, 19, 21, 22 mm		
BLOW CASE: W478 x D234 x H100 (mm)		

24PCS Professional Grade
1/2" DR. Flank Socket Set

1/2"

Magnetic Spark Plug Socket

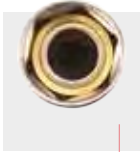

30PCS Professional Grade
Home Repairs & Maintenance Tool Set



ITEM NO.

6PT	Mirror	GCAI2401
CONTENTS  4 (SET)		
18 BAEA1608-1632 1/2" Dr. 6PT Flank Sockets 8, 9, 10, 11, 12, 13, 14, 15, 16, 17, 18, 19, 21, 22, 24, 27, 30, 32 mm		
2 CAAA1605 & 1610 1/2" Dr. Extension Bar - 5" & 10" (L)		
1 CAHA1678 1/2" Dr. Universal Joint		
1 CJBG1627 1/2" Dr. 36 Teeth Reversible Ratchet Handle with Quick Release		
1 CTCK1625 1/2" Dr. Sliding T-Handle - 10" (L)		
1 BAAT1621 1/2" Dr. Magnetic Spark Plug Socket - 21 mm		
BLOW CASE: W380 x D275 x H75 (mm)		

ITEM NO.

Satin	GAAI3001
CONTENTS  3 (SET)	
8 AAEJ0607-2022 Double Open End Wrenches 6x7, 8x9, 10x11, 12x13, 14x15, 16x17, 18x19, 20x22 mm	
9 GAAL0910 Hex Key Wrench Set (Short Type) 1.5, 2, 2.5, 3, 4, 5, 6, 8, 10 mm	
1 DBAA1209 High-Leverage Combination Pliers - 9" (L)	
1 DDAA1210 Groove-Joint Water Pump Pliers - 10" (L)	
1 HAAA0330 Engineers Hammer (300g)	
1 IAAA0005 Measuring Tape - 5M	
1 SCAA2017 Heavy Duty Utility Knife with Spare Blade - 165 mm (L)	
1 SBAA0414 Electricians Scissors - 138 mm (L)	
3 FBAB0006-0210 Phillips Anti-Slip Screwdrivers PH0, PH1, PH2	
4 FAAB0308-6E15 Slotted Anti-Slip Screwdrivers 3, 4, 5.5, 6.5 mm	
BLOW CASE: W478 x D234 x H100 (mm)	

Socket Sets & General Tool Sets

80PCS Professional Grade

1/4" & 1/2" DR. Tool Kit

1/4"
1/2"



ITEM NO.	GPT	Satin	GCAI8002
CONTENTS 2 (SET)			
9			AAEW0808-1919 15° Offset Super-Torque Combination Wrenches 8, 10, 12, 13, 14, 15, 17, 18, 19 mm
10			BAEA0804-0813 1/4" Dr. 6PT Flank Sockets 4, 5, 6, 7, 8, 9, 10, 11, 12, 13 mm
3			BAEE0808-0812 1/4" Dr. 6PT Flank Deep Sockets 8, 10, 12 mm
11			BAEA1614-1632 1/2" Dr. 6PT Flank Sockets 14, 15, 17, 18, 19, 21, 22, 24, 27, 30, 32 mm
3			BAEE1614-1619 1/2" Dr. 6PT Flank Deep Sockets 14, 17, 19 mm
2			BAAR1616 & 1621 1/2" Dr. Spark Plug Sockets - 16 & 21 mm
1			CAAA0804 1/4" Dr. Extension Bar - 4" (L)
2			CAAA1605 & 1610 1/2" Dr. Extension Bar - 5" & 10" (L)
1			CTCK0811 1/4" Dr. Sliding T-Handle
1			CTCK1625 1/2" Dr. Sliding T-Handle - 10" (L)
2			CAHA0840 & 1678 1/4" & 1/2" Dr. Universal Joint
1			CAIA0815 1/4" Dr. Spinner Handle
1			CASA0806 1/4" Dr. Flexible Extension Bar - 6" (L)
2			CJBG0815 & 1627 1/4" & 1/2" Dr. 36 Teeth Reversible Ratchet Handle with Quick Release
1			DDBA2210 Box-Joint Water Pump Pliers - 10" (L)
1			DFBB2208 Long Nose Pliers - 8" (L)
1			DBBB2207 Combination Pliers - 7" (L)
1			FTAB0808 1/4" Dr. x 1/4" (H) Quick Change Bit Holder
3			FBAB0108-0315 Phillips Anti-Slip Screwdrivers PH1x80, PH2x100, PH3x150
2			FAAB5E10 & 6E10 Slotted Anti-Slip Screwdrivers 5.5x100 & 6.5x100 mm
7			GAAV0704 1/4" Hex Shank Slotted Insert Bits FSAA0804-086E - 4, 5.5, 6.5 mm 1/4" Hex Shank Phillips Insert Bits FSBA0801-0802 - PH1 & PH2 1/4" Hex Shank Pozzi Insert Bits FSCA0801-0802 - PZ1 & PZ2
7			GAAV0702 1/4" Hex Shank Star Insert Bits FSEA0810-0840 - T10, T15, T20, T25, T27, T30, T40
7			GAAV0701 1/4" Hex Shank Hexagon Insert Bits FSDA0802-0808 - 2, 2.5, 3, 4, 5, 6, 8 mm
1			HAAA0330 Engineers Hammer (300g)

BLOW CASE: W473 x D345 x H82 (mm)

96PCS

1/4" & 1/2" DR. Tool Kit

1/4"
1/2"



ITEM NO.	GPT	Satin	GCAI9601
CONTENTS 2 (SET)			
9			BAEA0804-0810 1/4" Dr. 6PT Flank Sockets 4, 4.5, 5, 5.5, 6, 7, 8, 9, 10 mm
6			BAED0804-0810 1/4" Dr. Star Sockets E4, E5, E6, E7, E8, E10
1			CAAA0803 1/4" Dr. Extension Bar - 3" (L)
1			CASA0806 1/4" Dr. Flexible Extension Bar - 6" (L)
1			CAHA0840 1/4" Dr. Universal Joint
1			CTCK0811 1/4" Dr. Sliding T-Handle
1			CJBG0815 1/4" Dr. 36 Teeth Reversible Ratchet Handle with Quick Release
1			FTAB0808 1/4" Dr. x 1/4" (H) Quick Change Bit Holder
1			CAIP0816 1/4" Dr. Spinner Handle
10			FSDA0802-0812 1/4" Hex Shank Hexagon Insert Bits 2, 2.5, 3, 4, 5, 6, 7, 8, 10, 12 mm
10			FSEA0808-0850 1/4" Hex Shank Star Insert Bits T8, T10, T15, T20, T25, T27, T30, T40, T45, T50
20			BAEA1608-1632 1/2" Dr. 6PT Flank Sockets 8, 9, 10, 11, 12, 13, 14, 15, 16, 17, 18, 19, 20, 21, 22, 23, 24, 27, 30, 32 mm
6			BAED1611-1620 1/2" Dr. Star Sockets E11, E12, E14, E16, E18, E20
2			BAAR1616 & 1621 1/2" Dr. Spark Plug Sockets - 16 & 21 mm
2			CAAA1605 & 1610 1/2" Dr. Extension Bar - 5" & 10" (L)
1			CAHA1678 1/2" Dr. Universal Joint
1			CTCK1625 1/2" Dr. Sliding T-Handle
1			CJBG1627 1/2" Dr. 36 Teeth Reversible Ratchet Handle with Quick Release
11			AAEX0808-1919 15° Offset High Performance Combination Wrenches 8, 10, 11, 12, 13, 14, 15, 16, 17, 18, 19 mm
4			AEAA0810-1719 Flare Nut Wrenches 8x10, 11x13, 12x14, 17x19 mm
1			AMAC2420 Adjustable Wrench - 8" (L)
1			DBBB2207 Combination Pliers - 7" (L)
2			FBAB0108 & 0210 Phillips Anti-Slip Screwdrivers PH1x80 & PH2x100
2			FAAB5E10 & 6E15 Slotted Anti-Slip Screwdrivers 5.5x100 & 6.5x150

BLOW CASE: W473 x D345 x H82 (mm)

TOPTUL
BLOW CASE TOOL SET

97PCS

1/4" & 1/2" DR. Tool Kit

- 1/4"
- 1/2"



ITEM NO.	Satin	GCAI9701
CONTENTS 2 (SET)		
12	BAEA0804-0813	1/4" Dr. 6PT Flank Sockets 4, 4.5, 5, 5.5, 6, 7, 8, 9, 10, 11, 12, 13 mm
10	BAEE0804-0813	1/4" Dr. 6PT Flank Deep Sockets 4, 5, 6, 7, 8, 9, 10, 11, 12, 13 mm
1	CAHA0840	1/4" Dr. Universal Joint
1	CAAA0803	1/4" Dr. Extension Bar - 3" (L)
1	CASA0806	1/4" Dr. Flexible Extension Bar - 6" (L)
1	CTCK0811	1/4" Dr. Sliding T-Handle
1	CFAC0806	1/4" Dr. Swivel Handle - 6" (L)
1	FTAB0808	1/4" Dr. x 1/4 (H) Quick Change Bit Holder
7	GAAV0702	1/4" Hex Shank Star Insert Bits FSEA0810-0840 - T10, T15, T20, T25, T27, T30, T40
7	GAAV0704	1/4" Hex Shank Slotted Insert Bits FSAA0804-086E - 4, 5.5, 6.5 mm 1/4" Hex Shank Phillips Insert Bits FSBA0801 & 0802 - PH1 & PH2 1/4" Hex Shank Pozi Insert Bits FSCA0801 & 0802 - PZ1 & PZ2
1	CAIP0816	1/4" Dr. Spinner Handle
1	CJBG0815	1/4" Dr. 36 Teeth Reversible Ratchet Handle with Quick Release
18	BAEA1610-1632	1/2" Dr. 6PT Flank Sockets 10, 11, 12, 13, 14, 15, 16, 17, 18, 19, 20, 21, 22, 23, 24, 27, 30, 32 mm
10	BAEE1610-1624	1/2" Dr. 6PT Flank Deep Sockets 10, 12, 13, 14, 16, 17, 19, 21, 22, 24 mm
1	CAHA1678	1/2" Dr. Universal Joint
2	BAAR1616 & 1621	1/2" Dr. Spark Plug Sockets - 16 & 21 mm
2	CAAA1605 & 1610	1/2" Dr. Extension Bar - 5" & 10" (L)
1	CTCK1625	1/2" Dr. Sliding T-Handle
1	CFAC1615	1/2" Dr. Swivel Handle - 15" (L)
1	CJBG1627	1/2" Dr. 36 Teeth Reversible Ratchet Handle with Quick Release
9	GAAL0910	Short Type Hex Key Wrench Set 1.5, 2, 2.5, 3, 4, 5, 6, 8, 10 mm
1	FBBB0203	Stubby Phillips Anti-Slip Screwdriver PH2x25
2	FBAB0210 & 0315	Phillips Anti-Slip Screwdrivers PH2x100 & PH3x150
1	FABB6E03	Stubby Slotted Anti-Slip Screwdriver 6.5x25
1	FAAB5E10	Slotted Anti-Slip Screwdriver 5.5x100
1	DEBB2206	Diagonal Cutting Pliers - 6" (L)
1	DBBB2207	Combination Pliers - 7" (L)
1	AMAC2420	Adjustable Wrench - 8" (L)
BLOW CASE: W473 x D345 x H82 (mm)		

106PCS Professional Grade

1/4" & 1/2" DR. Flank Socket Wrench Set

- 1/4"
- 1/2"



ITEM NO.	6PT	Satin	GCAI106B
CONTENTS 2 (SET)			
13	BAEA0804-0814	1/4" Dr. 6PT Flank Sockets 4, 4.5, 5, 5.5, 6, 7, 8, 9, 10, 11, 12, 13, 14 mm	
3	BAEE0808-0812	1/4" Dr. 6PT Flank Deep Sockets 8, 10, 12 mm	
12	BAEA1615-1632	1/2" Dr. 6PT Flank Sockets 15, 16, 17, 18, 19, 20, 21, 22, 23, 24, 27, 32 mm	
3	BAEE1614-1619	1/2" Dr. 6PT Flank Deep Sockets 14, 17, 19 mm	
1	CAAA0804	1/4" Dr. Extension Bar - 4" (L)	
2	CAAA1605 & 1610	1/2" Dr. Extension Bar - 5" & 10" (L)	
1	CTCK0811	1/4" Dr. Sliding T-Handle	
1	CTCK1625	1/2" Dr. Sliding T-Handle - 10" (L)	
2	CAHA0840 & 1678	1/4" & 1/2" Dr. Universal Joint	
2	BAAR1616 & 1621	1/2" Dr. Spark Plug Sockets - 16 & 21 mm	
2	CJBG0815 & 1627	1/4" & 1/2" Dr. 36 Teeth Reversible Ratchet Handle with Quick Release	
1	CAIA0815	1/4" Dr. Spinner Handle	
1	FTBA0824	1/4" Dr. Magnetic Bit Holder with Handle	
2	FTAB0808 & 1610	1/4" Dr. x 1/4" (H) & 1/2" Dr. x 5/16" (H) Quick Change Bit Holder	
3	FSAA1008-1012	5/16" Hex Shank Slotted Insert Bits 8, 10, 12 mm	
2	FSBA1003 & 1004	5/16" Hex Shank Phillips Insert Bits PH3 & PH4	
2	FSCA1003 & 1004	5/16" Hex Shank Pozi Insert Bits PZ3 & PZ4	
3	FSEA1045-1055	5/16" Hex Shank Star Insert Bits T45, T50, T55	
4	FSDA1008-1014	5/16" Hex Shank Hexagon Insert Bits 8, 10, 12, 14 mm	
31	GAAW3101 - 31PCS Screwdriver Bit Set	FSBA: PH0, PH1x2pcs, PH2x2pcs, PH3 FSCA: PZ0, PZ1x2pcs, PZ2x2pcs, PZ3 FSAA: 4x0.5, 5.5x1, 6.5x1.2 mm FSDA: 3, 4, 5, 6 mm FSEA: T6, T7, T8, T9, T10, T15, T20, T25, T27, T30, T40 1/4" Dr. x 1/4" (H) Magnetic Bit Holder	
15	AAEW0606-2222	15" Offset Super-Torque Combination Wrenches 6, 7, 8, 9, 10, 11, 12, 13, 14, 15, 16, 17, 18, 19, 22 mm	
BLOW CASE: W473 x D345 x H82 (mm)			

Socket Sets & General Tool Sets

130PCS Professional Grade

1/4", 3/8" & 1/2" DR. Flank Socket Wrench Set
(METRIC & SAE)

1/4"

3/8"

1/2"

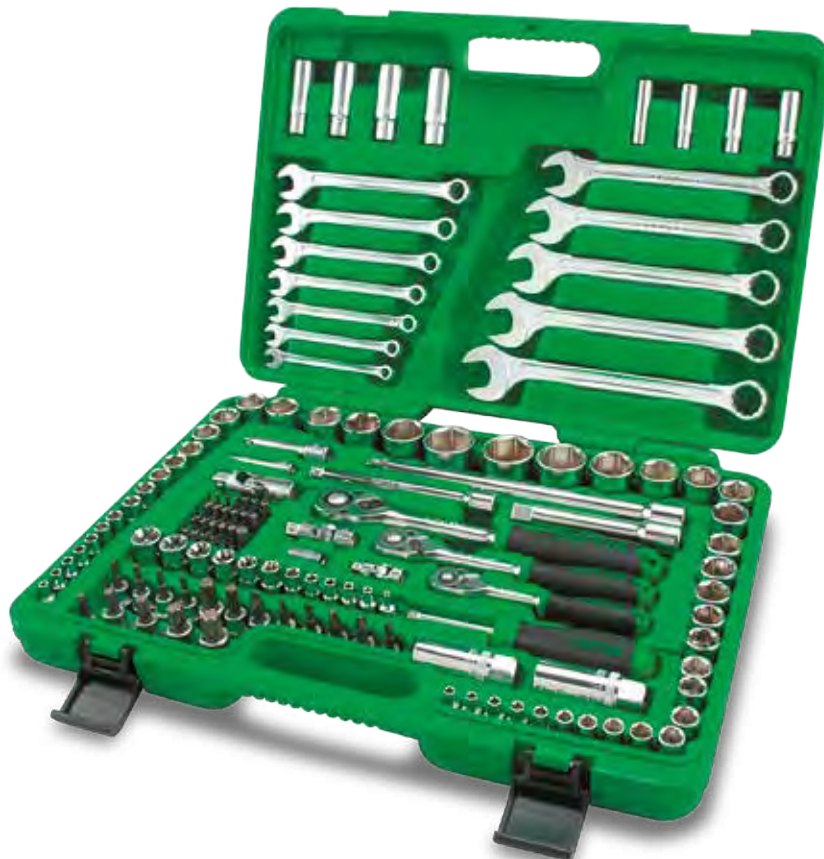

ITEM NO.

6PT	Satin	GCAI130B
-----	-------	----------

CONTENTS

2 (SET)

- | | |
|--|---|
| <p>6 BAED0804-0810
1/4" Dr. Star Sockets
E4, E5, E6, E7, E8, E10</p> <p>4 BAEE0808-0812
1/4" Dr. 6PT Flank Deep Sockets
8, 9, 10, 12 mm</p> <p>11 BAEA0804-0812
1/4" Dr. 6PT Flank Sockets
4, 4.5, 5, 5.5, 6, 7, 8, 9, 10, 11, 12 mm</p> <p>7 BBEA0805-0811
1/4" Dr. 6PT Flank Sockets
5/32", 3/16", 7/32", 1/4", 9/32", 5/16", 11/32"</p> <p>6 BAED1211-1220
3/8" Dr. Star Sockets
E11, E12, E14, E16, E18, E20</p> <p>4 BAEE1213-1217
3/8" Dr. 6PT Flank Deep Sockets
13, 14, 15, 17 mm</p> <p>7 BAEA1213-1219
3/8" Dr. 6PT Flank Sockets
13, 14, 15, 16, 17, 18, 19 mm</p> <p>9 BBEA1212-1228
3/8" Dr. 6PT Flank Sockets
3/8", 7/16", 1/2", 9/16", 5/8", 11/16", 3/4", 13/16", 7/8"</p> <p>7 BAEA1620-1632
1/2" Dr. 6PT Flank Sockets
20, 21, 22, 24, 27, 30, 32 mm</p> <p>4 BBEA1630-1640
1/2" Dr. 6PT Flank Sockets
15/16", 1", 1-1/16", 1-1/4"</p> <p>4 BCFA1645-1660
1/2" Dr. Star Bit Sockets
T45, T50, T55, T60</p> <p>5 BCFA1220-1240
3/8" Dr. Star Bit Sockets
T20, T25, T27, T30, T40</p> <p>2 BCDA1208 & 1210
3/8" Dr. Hex Bit Sockets - 8 & 10 mm</p> | <p>3 BCCA125E-1208
3/8" Dr. Slotted Bit Sockets
5.5, 6.5, 8 mm</p> <p>3 BCAA12P2-12P4
3/8" Dr. Phillips Bit Sockets - PH2, PH3, PH4</p> <p>7 GAAV0703
1/4" Hex Shank Star Tamperproof Insert Bits
FSGA0810-0840 - T10, T15, T20, T25, T27, T30, T40</p> <p>7 GAAV0702
1/4" Hex Shank Star Insert Bits
FSEA0810-0840 - T10, T15, T20, T25, T27, T30, T40</p> <p>7 GAAV0701
1/4" Hex Shank Hexagon Insert Bits
FSDA0802-0808 - 2, 2.5, 3, 4, 5, 6, 8 mm</p> <p>3 CAHA0840-1678
1/4", 3/8" & 1/2" Dr. Universal Joint</p> <p>3 CJBG0815-1627
1/4", 3/8" & 1/2" Dr. 36 Teeth Reversible Ratchet Handle with Quick Release</p> <p>1 FTAB0808
1/4" Dr. x 1/4" (H) Quick Change Bit Holder</p> <p>1 CAAA0802
1/4" Dr. Extension Bar - 2" (L)</p> <p>1 CAIP0816
1/4" Dr. Spinner Handle</p> <p>2 CAAA1203 & 1206
3/8" Dr. Extension Bar - 3" & 6" (L)</p> <p>2 BAAR1616 & 1621
1/2" Dr. Spark Plug Sockets - 16 & 21 mm</p> <p>2 CAAA1605 & 1610
1/2" Dr. Extension Bar - 5" & 10" (L)</p> <p>12 AAEW0808-2222
15° Offset Super-Torque Combination Wrenches
8, 9, 10, 11, 12, 13, 14, 17, 18, 19, 21, 22 mm</p> |
|--|---|

BLOW CASE: W473 x D345 x H82 (mm)

150PCS

1/4" & 1/2" DR. Tool Kit

1/4"

1/2"

Professional quality meets or exceeds both ANSI & DIN standards



Rugged blow molded case for perfect tool protection and storage



ITEM NO.

6PT	Satin	GCAI150R
12PT	Satin	GCAI150R1

CONTENTS 2 (SET)

- 12 BAEA0804-0813**
1/4" Dr. 6PT Flank Sockets - 4, 4.5, 5, 5.5, 6, 7, 8, 9, 10, 11, 12, 13 mm
- 8 BAEE0806-0813**
1/4" Dr. 6PT Flank Deep Sockets - 6, 7, 8, 9, 10, 11, 12, 13 mm
- 5 BAED0804-0808**
1/4" Dr. Star Sockets - E4, E5, E6, E7, E8
- 2 CAAA0802 & 0804**
1/4" Dr. Extension Bar - 2" & 4" (L)
- 1 CASA0806**
1/4" Dr. Flexible Extension Bar - 6" (L)
- 1 CTCK0811**
1/4" Dr. Sliding T-Handle
- 1 CAHA0840**
1/4" Dr. Universal Joint
- 1 FTAB0808**
1/4" Dr. x 1/4 (H) Quick Change Bit Holder
- 7 GAAV0704**
● 1/4" Hex Shank Slotted Insert Bits
FSAA0804-086E - 4, 5.5, 6.5 mm
⊕ 1/4" Hex Shank Phillips Insert Bits
FSBA0801 & 0802 - PH1 & PH2
⊕ 1/4" Hex Shank Pozi Insert Bits
FSCA0801 & 0802 - PZ1 & PZ2
- 7 GAAV0701**
○ 1/4" Hex Shank Hexagon Insert Bits
FSDA0802-0808 - 2, 2.5, 3, 4, 5, 6, 8 mm
- 7 GAAV0702**
○ 1/4" Hex Shank Star Insert Bits
FSEA0810-0840 - T10, T15, T20, T25, T27, T30, T40
- 7 GAAV0703**
⊕ 1/4" Hex Shank Star Tamperproof Insert Bits
FSGA0810-0840 - T10, T15, T20, T25, T27, T30, T40
- 1 CAIP0816**
1/4" Dr. Spinner Handle
- 1 CJBG0815**
1/4" Dr. 36 Teeth Reversible Ratchet Handle with Quick Release
- 20 BAEA1608-1632**
1/2" Dr. 6PT Flank Sockets
8, 9, 10, 11, 12, 13, 14, 15, 16, 17, 18, 19, 20, 21, 22, 23, 24, 27, 30, 32 mm
- 5 BAEE1614-1622**
1/2" Dr. 6PT Flank Deep Sockets - 14, 15, 17, 19, 22 mm
- 6 BAED1610-1620**
1/2" Dr. Star Sockets - E10, E12, E14, E16, E18, E20
- 2 CAAA1605 & 1610**
1/2" Dr. Extension Bar - 5" & 10" (L)
- 1 CAGA1216**
3/8" (F) x 1/2" (M) Dr. 3-Way Adaptor

CONTENTS

- 1 CAHA1678**
1/2" Dr. Universal Joint
- 2 BAAR1616 & 1621**
1/2" Dr. Spark Plug Sockets - 16 & 21mm
- 1 FTAB1610**
1/2" Dr. x 5/16" (H) Quick Change Bit Holder
- 1 FSBA1003**
⊕ 5/16" Hex Shank Phillips Insert Bits - PH3
- 2 FSDA1012 & 1014**
○ 5/16" Hex Shank Hexagon Insert Bits - 12 & 14 mm
- 2 FSEA1045 & 1050**
⊕ 5/16" Hex Shank Star Insert Bits - T45 & T50
- 1 CFAE1615**
1/2" Dr. Swivel Handle - 15" (L)
- 1 AFAN1610**
1/2" Dr. L-Handle (90° Offset) - 10" (L)
- 1 CJBG1627**
1/2" Dr. 36 Teeth Reversible Ratchet Handle with Quick Release
- 17 AAEX0606-2424**
15" Offset High-Performance Combination Wrenches
6, 7, 8, 9, 10, 11, 12, 13, 14, 15, 16, 17, 18, 19, 21, 22, 24 mm
- 4 AEEA0810-1719**
Flare Nut Wrench - 8x10, 11x13, 12x14, 17x19 mm
- 7 GAAL0701**
Short Type Hex Key Wrench Set - 2.5, 3, 4, 5, 6, 8, 10 mm
- 1 DBBB2207B**
Combination Pliers - 7" (L)
- 1 DEBB2206B**
Diagonal Cutting Pliers - 6" (L)
- 1 DAAQ1A10**
Curved Jaw Locking Pliers with Wire Cutter - 10" (L)
- 1 HAAA0532**
Engineers Hammer - 500g
- 5 GAAV0501**
Chisel Punch Set
Pin Punch - 4x9.5x150 mm
Cape Chisel - 5x9.5x130 mm
Cold Chisel - 12x9.5x130 mm
Taper Punch - 3x9.5x120 mm
Center Punch - #2x9.5x120 mm
- 1 FBBB0203**
⊕ Stubby Phillips Anti-Slip Screwdriver - PH2x25
- 2 FBAB0108 & 0210**
⊕ Phillips Anti-Slip Screwdrivers - PH1x80 & PH2x100
- 1 FABB6E03**
● Stubby Slotted Anti-Slip Screwdriver - 6.5x25
- 2 FAAB5E10 & 6E15**
● Slotted Anti-Slip Screwdrivers - 5.5x100 & 6.5x150

BLOW CASE: W560 x D412 x H120 (mm)

Socket Sets & General Tool Sets

21PCS Professional Grade

3/4" DR. Flank Socket Set

3/4"

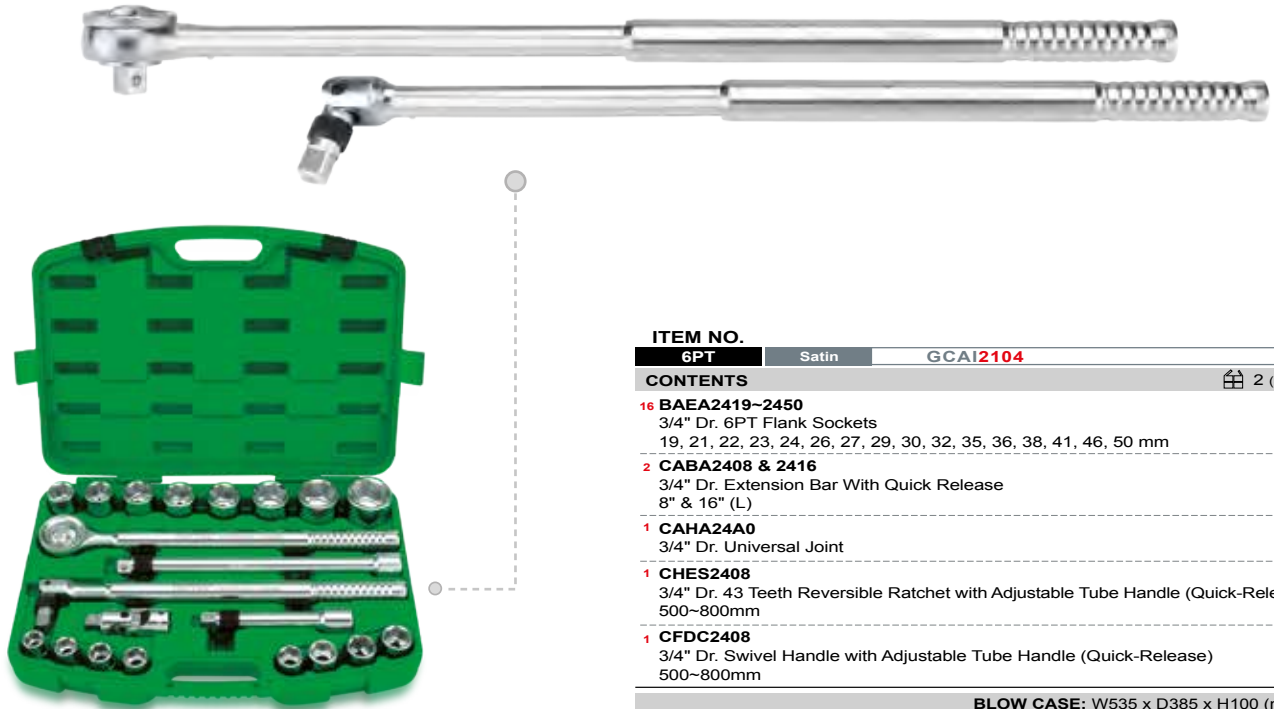

ITEM NO.

6PT	Satin	GCAI2104	2 (SET)
-----	-------	----------	---------

CONTENTS

- 16 BAEA2419~2450
3/4" Dr. 6PT Flank Sockets
19, 21, 22, 23, 24, 26, 27, 29, 30, 32, 35, 36, 38, 41, 46, 50 mm
- 2 CABA2408 & 2416
3/4" Dr. Extension Bar With Quick Release
8" & 16" (L)
- 1 CAHA24A0
3/4" Dr. Universal Joint
- 1 CHES2408
3/4" Dr. 43 Teeth Reversible Ratchet with Adjustable Tube Handle (Quick-Release)
500~800mm
- 1 CFDC2408
3/4" Dr. Swivel Handle with Adjustable Tube Handle (Quick-Release)
500~800mm

BLOW CASE: W535 x D385 x H100 (mm)

21PCS Professional Grade

3/4" DR. Flank Socket Set

3/4"



ITEM NO.

6PT	Satin	GCAI2102	2 (SET)
-----	-------	----------	---------

CONTENTS

- 16 BAEA2419~2450
3/4" Dr. 6PT Flank Sockets
19, 21, 22, 23, 24, 26, 27, 29, 30, 32, 35, 36, 38, 41, 46, 50 mm
- 2 CABA2408 & 2416
3/4" Dr. Extension Bar With Quick Release
8" & 16" (L)
- 1 CAHA24A0
3/4" Dr. Universal Joint
- 1 CFJB2419
3/4" Dr. Swivel Handle - 21" (L)
- 1 CHFS2451
3/4" Dr. 43 Teeth Reversible Ratchet Handle with Quick Release

BLOW CASE: W535 x D385 x H100 (mm)

17PCS Professional Grade

3/4" DR. Flank Socket Set

3/4"



ITEM NO.

6PT	Satin	GCAI1701	2 (SET)
-----	-------	----------	---------

CONTENTS

- 13 BAEA2419~2450
3/4" Dr. 6PT Flank Sockets
19, 21, 22, 23, 24, 27, 30, 32, 36, 38, 41, 46, 50 mm
- 2 CABA2404 & 2408
3/4" Dr. Extension Bar With Quick Release
4" & 8" (L)
- 1 CTCJ2418
3/4" Dr. Sliding T- Handle with Quick Release - 18" (L)
- 1 CHFS2451
3/4" Dr. 43 Teeth Reversible Ratchet Handle with Quick Release

BLOW CASE: W602 x D205 x H102 (mm)

31PCS
1/4" DR. Socket Set
1/4"



ITEM NO.	6PT	Satin	GCAD3102	
CONTENTS	10 (SET)			
11 BAEA0804-0814	1/4" Dr. 6PT Flank Sockets 4, 5, 6, 7, 8, 9, 10, 11, 12, 13, 14 mm			
3 BCBA08P1-08P3	1/4" Dr. Pozi Bit Sockets - PZ1, PZ2, PZ3			
3 BCAA08P1-08P3	1/4" Dr. Phillips Bit Sockets - PH1, PH2, PH3			
3 BCCA0804-086E	1/4" Dr. Slotted Bit Sockets - 4, 5.5, 6.5 mm			
5 BCDA0803-0808	1/4" Dr. Hex Bit Sockets - 3, 4, 5, 6, 8 mm			
1 CAIP0816	1/4" Dr. Spinner Handle			
1 CJBG0815	1/4" Dr. 36 Teeth Reversible Ratchet Handle with Quick Release			
2 CAAA0802 & 0806	1/4" Dr. Extension Bar - 2" & 6" (L)			
1 CAHA0840	1/4" Dr. Universal Joint			
1 CTCK0811	1/4" Dr. Sliding T-Handle			
METAL CASE: W221 x D129 x H44 (mm)				

39PCS
3/8" DR. Socket Set
3/8"



ITEM NO.	6PT	Satin	GCAD3902	
CONTENTS	3 (SET)			
15 BAEA1208-1222	3/8" Dr. 6PT Flank Sockets 8, 9, 10, 11, 12, 13, 14, 15, 16, 17, 18, 19, 20, 21, 22 mm			
6 BAAE1208-1219	3/8" Dr. 6PT Flank Deep Sockets 8, 10, 12, 13, 17, 19 mm			
2 CAAA1203 & 1206	3/8" Dr. Extension Bar - 3" & 6" (L)			
2 BAAT1216 & 1221	3/8" Dr. Magnetic Spark Plug Sockets - 16 & 21 mm			
2 BCDA1205 & 1206	3/8" Dr. Hex Bit Sockets - 5 & 6 mm			
1 BDDA1208	3/8" Dr. Hex Bit Socket - 1/4"			
2 BCFA1215 & 1220	3/8" Dr. Star Bit Sockets - T15 & T20			
2 BCAA12P1 & 12P2	3/8" Dr. Phillips Bit Sockets - PH1 & PH2			
2 BCBA12P1 & 12P2	3/8" Dr. Pozi Bit Sockets - PZ1 & PZ2			
1 BCCA125E	3/8" Dr. Slotted Bit Socket - 5.5 mm			
1 CAHA1254	3/8" Dr. Universal Joint			
1 CAEA1216	3/8"(F) x 1/2"(M) Adapter			
1 CTCJ1208	3/8" Dr. Sliding T-Handle With Quick Release			
1 CJBM1220	3/8" Dr. 72 Teeth Reversible Ratchet Handle with Quick Release			
METAL CASE: W440 x D190 x H52 (mm)				

29PCS
1/4" DR. Socket Set
(METRIC & SAE)
1/4"



ITEM NO.	6PT	Mirror	GCAD2901	
CONTENTS	10 (SET)			
13 BAEA0804-0814	1/4" Dr. 6PT Flank Sockets 4, 4.5, 5, 5.5, 6, 7, 8, 9, 10, 11, 12, 13, 14 mm			
10 BBEA0806-0818	1/4" Dr. 6PT Flank Sockets 3/16", 7/32", 1/4", 9/32", 5/16", 11/32", 3/8", 7/16", 1/2", 9/16"			
1 CAIP0816	1/4" Dr. Spinner Handle			
1 CJBG0815	1/4" Dr. 36 Teeth Reversible Ratchet Handle with Quick Release			
2 CAAA0802 & 0806	1/4" Dr. Extension Bar - 2" & 6" (L)			
1 CAHA0840	1/4" Dr. Universal Joint			
1 CTCK0811	1/4" Dr. Sliding T-Handle			
METAL CASE: W221 x D129 x H44 (mm)				

34PCS
1/4" & 1/2" DR. Socket Set
1/4"
1/2"



ITEM NO.	6PT	Mirror	GCAD3402	
CONTENTS	3 (SET)			
10 BAEA0805-0813	1/4" Dr. 6PT Flank Sockets 5, 5.5, 6, 7, 8, 9, 10, 11, 12, 13 mm			
17 BAEA1610-1632	1/2" Dr. 6PT Flank Sockets 10, 11, 12, 13, 14, 15, 16, 17, 18, 19, 21, 22, 24, 27, 29, 30, 32 mm			
1 CAAA0804	1/4" Dr. Extension Bar - 4" (L)			
1 CAAA1605	1/2" Dr. Extension Bar - 5" (L)			
2 CAHA0840 & 1678	1/4" & 1/2" Dr. Universal Joint			
1 CTCK0811	1/4" Dr. Sliding T-Handle			
2 CJBG0815 & 1627	1/4" & 1/2" Dr. 36 Teeth Reversible Ratchet Handle with Quick Release			
METAL CASE: W440 x D190 x H52 (mm)				

34PCS
3/8" DR. Socket Set
(METRIC & SAE)
3/8"



ITEM NO.	6PT	Satin	GCAD3403	
CONTENTS	3 (SET)			
11 BAEA1208-1222	3/8" Dr. 6PT Flank Sockets 8, 10, 12, 13, 14, 16, 17, 18, 19, 21, 22 mm			
11 BBEA1210-1228	3/8" Dr. 6PT Flank Sockets 5/16", 3/8", 7/16", 1/2", 9/16", 5/8", 11/16", 3/4", 25/32", 13/16", 7/8"			
2 BAAR1216 & 1221	3/8" Dr. Spark Plug Sockets - 16 & 21 mm			
1 CJBG1220	3/8" Dr. 36 Teeth Reversible Ratchet Handle with Quick Release			
3 CAAA1203-1210	3/8" Dr. Extension Bar - 3", 6", 10" (L)			
1 CTCJ1208	3/8" Dr. Sliding T-Handle with Quick Release			
1 CFKA1210	3/8" Dr. Swivel Handle			
1 CAHA1254	3/8" Dr. Universal Joint			
1 CADC1240	3/8" Dr. Speed Brace			
1 CAEB0812	1/4"(F) x 3/8"(M) Dr. Adapter			
1 CAIP0816	1/4" Dr. Spinner Handle			
METAL CASE: W440 x D190 x H52 (mm)				

Socket Sets & General Tool Sets

9PCS

1/2" DR. Long Hex Bit Socket Set

1/2"



ITEM NO.	CONTENTS	10 (SET)
Satin		

GAAD0905 9 BCWA1604-1617
 ○ 1/2" Dr. Long Hex Bit Sockets (80mmL)
 4, 5, 6, 7, 8, 10, 12, 14, 17 mm

METAL CASE: W197 x D103 x H33 (mm)

10PCS

1/2" DR. Hex Bit Socket Set

1/2"



ITEM NO.	CONTENTS	10 (SET)
Satin		

GAAD1007 10 BCDA1604-1619
 ○ 1/2" Dr. Hex Bit Sockets (55mmL)
 4, 5, 6, 7, 8, 10, 12, 14, 17, 19 mm

METAL CASE: W197 x D103 x H33 (mm)

9PCS

1/2" DR. Star Bit Socket Set

1/2"



ITEM NO.	CONTENTS	10 (SET)
Satin		

GAAD0903 9 BCFA1620-1660
 ○ 1/2" Dr. Star Bit Sockets (55mmL)
 T20, T25, T27, T30, T40, T45, T50, T55, T60

METAL CASE: W197 x D103 x H33 (mm)

9PCS

1/2" DR. Long Star Bit Socket Set

1/2"



ITEM NO.	CONTENTS	10 (SET)
Satin		

GAAD0906 9 BCXA1620-1660
 ○ 1/2" Dr. Long Star Bit Sockets (80mmL)
 T20, T25, T27, T30, T40, T45, T50, T55, T60

METAL CASE: W197 x D103 x H33 (mm)

72PCS

1/4" DR. Socket & Ball Point Hex Key Wrench Set

1/4"



ITEM NO.	CONTENTS	3 (SET)
6PT Satin GCAD7202		

- 13 BAEA0804-0814
1/4" Dr. 6PT Flank Sockets
4, 4.5, 5, 5.5, 6, 7, 8, 9, 10, 11, 12, 13, 14 mm
- 13 BAAE0804-0814
1/4" Dr. 6PT Flank Deep Sockets
4, 4.5, 5, 5.5, 6, 7, 8, 9, 10, 11, 12, 13, 14 mm
- 7 BCDA082E-0808
○ 1/4" Dr. Hex Bit Sockets
2.5, 3, 4, 5, 6, 7, 8 mm
- 6 BCCA0803-0808
● 1/4" Dr. Slotted Bit Sockets
3, 4, 4.5, 5.5, 6.5, 8 mm
- 5 BCXA08P0-08P4
⊕ 1/4" Dr. Phillips Bit Sockets
PH0, PH1, PH2, PH3, PH4
- 4 BCBA08P0-08P3
⊕ 1/4" Dr. Pozi Bit Sockets
PZ0, PZ1, PZ2, PZ3
- 8 BCFA0808-0840
○ 1/4" Dr. Star Bit Sockets
T8, T10, T15, T20, T25, T27, T30, T40
- 1 CTCK0811
1/4" Dr. Sliding T- Handle
- 1 CAHA0840
1/4" Dr. Universal Joint
- 1 CAIA0815
1/4" Dr. Spinner Handle
- 9 GAAL0916
Long Type Ball Point Hex Key Wrench Set
- 1 CJBM0815
1/4" Dr. 72 Teeth Reversible Ratchet Handle with Quick Release
- 3 CAAA0802-0806
1/4" Dr. Extension Bar - 2", 4", 6" (L)

METAL CASE: W445 x D188 x H50 (mm)

25PCS

3/8" DR. Socket Set

3/8"



ITEM NO.	Satin	GCAD2502	4 (SET)
CONTENTS			
18	BAEA1206-1224	3/8" Dr. 6PT Flank Sockets 6, 7, 8, 9, 10, 11, 12, 13, 14, 15, 16, 17, 18, 19, 20, 21, 22, 24 mm	
2	CAAA1203 & 1206	3/8" Dr. Extension Bar - 3" & 6" (L)	
1	CAHA1254	3/8" Dr. Universal Joint	
2	BAAT1216 & 1221	3/8" Dr. Magnetic Spark Plug Sockets - 16 & 21 mm	
1	CJBG1220	3/8" Dr. 36 Teeth Reversible Ratchet Handle with Quick Release	
1	CTCK1220	3/8" Dr. Sliding T-Handle	
METAL CASE: W370 x D154 x H50 (mm)			

27PCS

1/4" & 1/2" DR. Socket Set

1/4"

1/2"



ITEM NO.	6PT	Mirror	GCAD2802	6 (SET)
CONTENTS				
9	BAEA0805-0813	1/4" Dr. 6PT Flank Sockets 5, 6, 7, 8, 9, 10, 11, 12, 13 mm		
11	BAEA1610-1627	1/2" Dr. 6PT Flank Sockets 10, 11, 12, 13, 14, 16, 17, 19, 21, 24, 27 mm		
2	CHAG0813 & 1626	1/4" & 1/2" Dr. 36 Teeth Reversible Ratchet Handle with Quick Release		
1	CTCK0811	1/4" Dr. Sliding T-Handle		
2	CAHA0840 & 1678	1/4" & 1/2" Dr. Universal Joint		
1	CAAA0804	1/4" Dr. Extension Bar - 4" (L)		
1	CAAA1605	1/2" Dr. Extension Bar - 5" (L)		
METAL CASE: W324 x D149 x H48 (mm)				

27PCS

1/4" DR. Socket Set

1/4"

-NEW



Stubby 19.5mmL One-Piece Construction Bit Sockets

- Made of SNCM+V Alloy Steel
- Black Phosphate Finish
- Ideal for Use in Confined Spaces

ITEM NO.	6PT	Satin	GCAD2701	10 (SET)
CONTENTS				
11	BAEA0804-0813	1/4" Dr. 6PT Flank Sockets 4, 5, 5.5, 6, 7, 8, 9, 10, 11, 12, 13 mm		
1	CAHA0840	1/4" Dr. Universal Joint		
2	CAAA0802 & 0804	1/4" Dr. Extension Bar - 2" & 4" (L)		
1	CTCK0811	1/4" Dr. Sliding T-Handle		
1	S135	1/4" Dr. 36 Teeth Reversible Ratchet Handle with Quick Release		
1	CAIA0815	1/4" Dr. Spinner Handle		
4	BCDB0804-0808	1/4" Dr. One-Piece Stubby Hex Bit Sockets 4, 5, 6, 8 mm		
3	BCCB084E-0808	1/4" Dr. One-Piece Stubby Slotted Bit Sockets 4.5, 6.5, 8 mm		
3	BCAB08P1-08P3	1/4" Dr. One-Piece Stubby Phillips Bit Sockets PH1, PH2, PH3		
METAL CASE: W197 x D103 x H33 (mm)				

27PCS

3/8" DR. Socket Wrench Set

3/8"



ITEM NO.	6PT	Mirror	GCAD2801	6 (SET)
CONTENTS				
10	BAEA1208-1217	3/8" Dr. 6PT Flank Sockets 8, 9, 10, 11, 12, 13, 14, 15, 16, 17 mm		
1	CAHA1254	3/8" Dr. Universal Joint		
1	CAGA1612	1/2"(F) x 3/8"(M) Dr. 3-Way Adapter		
2	CAAA1203 & 1206	3/8" Dr. Extension Bar - 3" & 6" (L)		
1	CHAG1218	3/8" Dr. 36 Teeth Reversible Ratchet Handle with Quick Release		
2	BAAR1216 & 1221	3/8" Dr. Spark Plug Sockets - 16 & 21 mm		
10	AAAB0808-1717	Standard Combination Wrenches 8, 9, 10, 11, 12, 13, 14, 15, 16, 17 mm		
METAL CASE: W324 x D149 x H48 (mm)				

Socket Sets & General Tool Sets

TOPTUL

HEAVY DUTY SOCKET SET SERIES

14PCS Professional Grade

1" DR. 6PT Flank Socket Set (METRIC)

1"



ITEM NO.		
6PT	Satin	GCAD1404
CONTENTS  1 (SET)		
10 BAEA3236-3280 1" Dr. 6PT Flank Sockets 36, 41, 46, 50, 55, 60, 65, 70, 75, 80 mm		
2 CAAO3208 & 3216 1" Dr. Extension Bar - 8" & 16" (L)		
1 CHND3226 1" Dr. 24 Teeth Reversible Ratchet with Tube Handle - 26" (L)		
1 CAGA3232 1" Dr. 3-Way Adapter: \square 1"(F) x \square 1"(M) x \circ 34mm - 75mm (L)		
METAL CASE: W660 x D205 x H108 (mm)		

14PCS Professional Grade

1" DR. 6PT Socket Set (METRIC)

1"



ITEM NO.		
6PT	Satin	GCAD1402
CONTENTS  1 (SET)		
10 BAEA3236-3280 1" Dr. 6PT Flank Sockets 36, 41, 46, 50, 55, 60, 65, 70, 75, 80 mm		
2 CAAO3208 & 3216 1" Dr. Extension Bar - 8" & 16" (L)		
1 CHNC3232 1" Dr. 24 Teeth Reversible Ratchet with Tube Handle (Quick Release) - 32" (L)		
1 CTCK3222 1" Dr. Sliding T- Handle - 22" (L)		
METAL CASE: W660 x D205 x H108 (mm)		

26PCS Professional Grade

3/4" DR. 12PT Flank Socket Set (METRIC & SAE)

3/4"



ITEM NO.		
12PT	Satin	GCAD2608
CONTENTS  1 (SET)		
10 BAEB2422-2450 3/4" Dr. 12PT Flank Sockets 22, 24, 27, 30, 32, 36, 38, 41, 46, 50 mm		
12 BBEB2428-2464 3/4" Dr. 12PT Flank Sockets 7/8", 15/16", 1", 1-1/8", 1-3/16", 1-5/16", 1-3/8", 1-7/16", 1-5/8", 1-3/4", 1-7/8", 2"		
2 CAAO2404 & 2408 3/4" Dr. Extension Bar - 4" & 8" (L)		
1 CTCA2451 3/4" Dr. Sliding T-Handle - 20" (L)		
1 CHNC2420 3/4" Dr. 24 Teeth Reversible Ratchet with Tube Handle (Quick Release) - 20" (L)		
METAL CASE: W536 x D178 x H79 (mm)		

14PCS Professional Grade

3/4" Dr. 6PT Flank Socket Set (METRIC)

3/4"



ITEM NO.		
6PT	Satin	GCAD1405
CONTENTS  1 (SET)		
10 BAEA2422-2450 3/4" Dr. 6PT Flank Sockets 22, 24, 27, 30, 32, 36, 38, 41, 46, 50 mm		
2 CAAO2404 & 2408 3/4" Dr. Extension Bar - 4" & 8" (L)		
1 CTCA2451 3/4" Dr. Sliding T-Handle - 20" (L)		
1 CHNC2420 3/4" Dr. 24 Teeth Reversible Ratchet with Tube Handle (Quick Release) - 20" (L)		
METAL CASE: W536 x D178 x H79 (mm)		

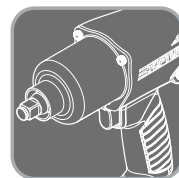

Impact Sockets, Bit Sockets, Accessories & Air Wrench Series **Specialized**

impact tools for auto maintenance and repairs. Available in 3/8", 1/2", 3/4" & 1".

IMPACT SOCKETS, BIT SOCKETS, ACCESSORIES & AIR WRENCH SERIES



Impact Sockets, Bit Sockets, Accessories & Air Wrench

6PT Flank Impact Sockets

CR-MO DIN 3121



METRIC

Black Phosphate Finished

DRIVE	ITEM NO.	SIZE(mm)	L(mm)		
3/8" 9.5mm sq.	KABA1208	8	30	15	270
	KABA1209	9	30	15	270
	KABA1210	10	30	15	270
	KABA1211	11	30	10	180
	KABA1212	12	30	10	180
	KABA1213	13	30	10	180
	KABA1214	14	30	10	160
	KABA1215	15	30	10	160
	KABA1216	16	30	10	160
	KABA1217	17	30	10	160
	KABA1218	18	30	10	160
	KABA1219	19	30	10	160
	KABA1220	20	30	10	160
	KABA1221	21	30	10	160
KABA1222	22	30	10	160	
1/2" 12.7mm sq.	KABA1608	8	38	25	150
	KABA1609	9	38	25	150
	KABA1610	10	38	25	150
	KABA1611	11	38	25	150
	KABA1612	12	38	25	150
	KABA1613	13	38	25	150
	KABA1614	14	38	25	150
	KABA1615	15	38	25	100
	KABA1616	16	38	20	80
	KABA1617	17	40	20	80
	KABA1618	18	40	15	60
	KABA1619	19	40	15	60
	KABA1620	20	40	15	60
	KABA1621	21	40	15	60

DRIVE	ITEM NO.	SIZE(mm)	L(mm)		
1/2" 12.7mm sq.	KABA1622	22	40	15	60
	KABA1623	23	42	15	60
	KABA1624	24	42	10	60
	KABA1625	25	42	10	60
	KABA1626	26	45	10	60
	KABA1627	27	45	10	60
	KABA1628	28	45	10	60
	KABA1629	29	45	10	60
	KABA1630	30	46	10	80
	KABA1632	32	46	5	40
	KABA2417	17	50	5	40
	KABA2419	19	50	5	40
	KABA2421	21	50	5	40
	KABA2422	22	50	5	40
3/4" 19.0mm sq.	KABA2423	23	50	5	40
	KABA2424	24	50	5	40
	KABA2426	26	50	5	40
	KABA2427	27	50	5	40
	KABA2428	28	50	5	40
	KABA2429	29	53	5	40
	KABA2430	30	53	5	40
	KABA2432	32	53	5	40
	KABA2433	33	55	5	40
	KABA2434	34	55	5	40
	KABA2435	35	55	5	40
	KABA2436	36	55	5	40
	KABA2438	38	57	2	16
	KABA2441	41	57	2	16
1" 25.4mm sq.	KABA2446	46	62	2	16
	KABA3222	22	57	2	16
	KABA3223	23	57	2	16
	KABA3224	24	57	2	16
	KABA3226	26	57	2	16
	KABA3227	27	57	2	16
	KABA3229	29	57	2	16
	KABA3230	30	62	2	16
	KABA3232	32	62	2	16
	KABA3233	33	62	2	16
	KABA3234	34	62	2	16
	KABA3235	35	62	2	16
	KABA3236	36	62	2	16
	KABA3238	38	66	2	16
KABA3241	41	66	2	16	
KABA3246	46	70	2	16	
KABA3250	50	70	2	16	
KABA3255	55	82	2	8	
KABA3260	60	85	2	8	
KABA3265	65	85	2	8	
KABA3270	70	90	2	8	

6PT Flank Impact Sockets

CR-MO DIN 3121



SAE

Black Phosphate Finished

DRIVE	ITEM NO.	SIZE(inch)	L(mm)		
1/2" 12.7mm sq.	KBBA1610	5/16	38	25	150
	KBBA1612	3/8	38	25	150
	KBBA1614	7/16	38	25	150
	KBBA1616	1/2	38	25	150
	KBBA1618	9/16	38	25	150
	KBBA1620	5/8	38	20	80
	KBBA1622	11/16	38	20	80
	KBBA1624	3/4	38	15	60
	KBBA1626	13/16	38	15	60
	KBBA1628	7/8	38	15	60
	KBBA1630	15/16	38	10	60
	KBBA1632	1	38	10	60
	KBBA1634	1-1/16	40	10	60
	KBBA1636	1-1/8	40	10	60
KBBA1638	1-3/16	40	10	80	
KBBA1640	1-1/4	40	5	40	

6PT Flank Deep Impact Sockets

CR-MO DIN 3121



METRIC

Black Phosphate Finished

DRIVE	ITEM NO.	SIZE(mm)	L(mm)		
3/8" 9.5mm sq.	KABE1208	8	65	10	160
	KABE1209	9	65	10	160
	KABE1210	10	65	10	160
	KABE1211	11	65	10	160
	KABE1212	12	65	10	160
	KABE1213	13	65	10	160
	KABE1214	14	65	10	160
	KABE1215	15	65	10	100
	KABE1216	16	65	10	100
	KABE1217	17	65	10	100
	KABE1218	18	65	10	100
	KABE1219	19	65	10	100
	KABE1220	20	65	5	50
	KABE1221	21	65	5	50
KABE1222	22	65	5	50	
1/2" 12.7mm sq.	KABE1608	8	78	10	80
	KABE1609	9	78	10	80
	KABE1610	10	78	10	80
	KABE1611	11	78	10	80
	KABE1612	12	78	10	80
	KABE1613	13	78	10	80
	KABE1614	14	78	10	80
	KABE1615	15	78	10	80
	KABE1616	16	78	10	80
	KABE1617	17	78	10	40
	KABE1618	18	78	10	40
	KABE1619	19	78	10	40
	KABE1620	20	78	10	40

DRIVE	ITEM NO.	SIZE(mm)	L(mm)		
1/2" 12.7mm sq.	KABE1621	21	78	10	40
	KABE1622	22	78	10	40
	KABE1623	23	78	10	40
	KABE1624	24	78	10	40
	KABE1625	25	78	10	40
	KABE1626	26	78	10	40
	KABE1627	27	78	8	32
	KABE1628	28	78	8	32
	KABE1629	29	78	8	32
	KABE1630	30	78	5	20
	KABE1632	32	78	5	20
	KABE2419	19	90	5	30
	KABE2421	21	90	5	30
	KABE2422	22	90	5	30
3/4" 19.0mm sq.	KABE2423	23	90	5	30
	KABE2424	24	90	5	30
	KABE2426	26	90	5	30
	KABE2427	27	90	5	30
	KABE2428	28	90	5	30
	KABE2429	29	90	2	16
	KABE2430	30	90	2	16
	KABE2432	32	90	2	16
	KABE2433	33	90	2	16
	KABE2434	34	90	2	16
	KABE2435	35	90	2	16
	KABE2436	36	90	2	16
	KABE2438	38	90	2	16
	KABE2441	41	90	2	16
KABE2446	46	90	2	16	
1" 25.4mm sq.	KABE3222	22	108	1	8
	KABE3224	24	108	1	8
	KABE3227	27	108	1	8
	KABE3229	29	108	1	8
	KABE3230	30	108	1	8
	KABE3232	32	108	1	8
	KABE3233	33	108	1	8
	KABE3234	34	108	1	8
	KABE3235	35	108	1	8
	KABE3236	36	108	1	8
	KABE3238	38	108	1	8
	KABE3241	41	108	1	8
	KABE3246	46	108	1	8
	KABE3250	50	108	1	8
KABE3255	55	108	1	6	
KABE3260	60	108	1	6	
KABE3265	65	108	1	6	
KABE3270	70	108	1	6	

6PT Flank Deep Impact Sockets



SAE

Black Phosphate Finished

DRIVE	ITEM NO.	SIZE(inch)	L(mm)		
1/2" 12.7mm sq.	KBBE1610	5/16	78	10	80
	KBBE1612	3/8	78	10	80
	KBBE1614	7/16	78	10	80
	KBBE1616	1/2	78	10	80
	KBBE1618	9/16	78	10	80
	KBBE1620	5/8	78	10	80
	KBBE1622	11/16	78	10	40
	KBBE1624	3/4	78	10	40
	KBBE1626	13/16	78	10	40
	KBBE1628	7/8	78	10	40
	KBBE1630	15/16	78	10	40
	KBBE1632	1	78	10	40
	KBBE1634	1-1/16	78	8	32
	KBBE1636	1-1/8	78	8	32
KBBE1638	1-3/16	78	5	20	
KBBE1640	1-1/4	78	5	20	

Impact Sockets, Bit Sockets, Accessories & Air Wrench

Impact Sockets, Bit Sockets, Accessories & Air Wrench

1/2" DR. Star Impact Sockets

CR-MO DIN 3121



DRIVE	ITEM NO.	SIZE	L(mm)		
1/2" 12.7mm sq.	KABK1610	E10	38	25	150
	KABK1612	E12	38	25	150
	KABK1614	E14	38	25	150
	KABK1616	E16	38	25	150
	KABK1618	E18	38	25	150
	KABK1620	E20	38	20	120
	KABK1624	E24	40	15	120

Black Phosphate Finished

Impact Extension Bar

CR-MO DIN 3121



Black Phosphate Finished

DRIVE	ITEM NO.	L(inch)		
3/8" (9.5mm)	KACE1203	3	25	200
	KACE1206	6	10	120
1/2" (12.7mm)	KACE1603	3	10	80
	KACE1605	5	10	80
	KACE1610	10	5	40
3/4" (19.0mm)	KACE2404	4	2	32
	KACE2407	7	2	20
	KACE2410	10	2	16
1" (25.4mm)	KACE2413	13	2	16
	KACE3207	7	2	16
	KACE3210	10	2	12
	KACE3213	13	2	12

7PCS

1/2" DR. Star Impact Socket Rail Set



ITEM NO.	CONTENTS		
GDAG0701	7 KABK1610-1624 E10, E12, E14, E16, E18, E20, E24	10 (SET)	

Black Phosphate Finished

Mini Oiler

For automatic oiling of compressed air tools
Extends the service life of pneumatic tools
Compact design and refillable
Solid brass construction
Air Inlet & Outlet Thread: 6.3mm (1/4")
Filling Capacity: 5 c.c.



ITEM NO.	SIZE	L(mm)		
KALA0815	1/4" PT	54	20	80

Impact Universal Joint

CR-MO DIN 3121



TOPTUL new developed impact universal joint provides 360 degrees of rotation at up to a 30 degree angle from vertical. The swivel mechanism is designed with the locking pin inside the socket wall for high strength, durability and safety.

Black Phosphate Finished

DRIVE	ITEM NO.	L(mm)		
3/8" (9.5mm)	KACU12A5	48	15	240
1/2" (12.7mm)	KACU1606	62	15	120
3/4" (19.0mm)	KACU2410	95	4	40
1" (25.4mm)	KACU3212	114	1	8

Impact Adaptor

CR-MO DIN 3121



Black Phosphate Finished

DRIVE	ITEM NO.	SIZE	L(mm)		
3/8" (9.5mm)	KACA1216	3/8"(F) x 1/2"(M)	33	10	180
1/2" (12.7mm)	KACA1624	1/2"(F) x 3/4"(M)	44	20	160
3/4" (19.0mm)	KACA2416	3/4"(F) x 1/2"(M)	58	5	50
	KACA2432	3/4"(F) x 1"(M)	58	5	50
1" (25.4mm)	KACA3224	1"(F) x 3/4"(M)	70	2	16

Star Bit Impact Sockets

(SNCM+V) (DIN 3121)



Black Phosphate Finished

DRIVE	ITEM NO.	SIZE	L(mm)		
3/8" 9.5mm sq.	KADA1220	T20	52	25	200
	KADA1225	T25	52	25	200
	KADA1227	T27	52	25	200
	KADA1230	T30	52	25	200
	KADA1240	T40	52	25	200
	KADA1245	T45	52	25	200
	KADA1250	T50	52	25	200
1/2" 12.7mm sq.	KADA1625	T25	60	25	200
	KADA1627	T27	60	25	200
	KADA1630	T30	60	25	200
	KADA1640	T40	60	25	200
	KADA1645	T45	60	25	200
	KADA1650	T50	60	25	200
	KADA1655	T55	60	25	200
	KADA1660	T60	60	25	200
	KADA1670	T70	60	25	200

Hex Bit Impact Sockets

(SNCM+V) (DIN 3121)



Black Phosphate Finished

DRIVE	ITEM NO.	SIZE(mm)	L(mm)			
3/8" 9.5mm sq.	KADH1203	3	52	25	200	
	KADH1204	4	52	25	200	
	KADH1205	5	52	25	200	
	KADH1206	6	52	25	200	
	KADH1207	7	52	25	200	
	KADH1208	8	52	25	200	
	KADH1210	10	52	25	200	
	KADH1212	12	52	25	200	
	1/2" 12.7mm sq.	KADH1604	4	60	25	200
		KADH1605	5	60	25	200
KADH1606		6	60	25	200	
KADH1607		7	60	25	200	
KADH1608		8	60	25	200	
KADH1609		9	60	25	100	
KADH1610		10	60	25	100	
KADH1612		12	60	25	100	
KADH1614		14	60	25	100	
KADH1617		17	60	25	100	
KADH1619	19	60	25	100		

3/4" DR. Star Bit Impact Sockets

(CR-MO) (DIN 3121)



Black Phosphate Finished

DRIVE	ITEM NO.	SIZE	L(mm)		
3/4" 19.0mm sq.	KADA2470	T70	105	5	40
	KADA2480	T80	105	5	40
	KADA2490	T90	105	5	40
	KADA24A0	T100	105	5	40

3/4" DR. Hex Bit Impact Sockets

(CR-MO) (DIN 3121)



Black Phosphate Finished

DRIVE	ITEM NO.	SIZE(mm)	L(mm)		
3/4" 19.0mm sq.	KADH2414	14	105	5	40
	KADH2417	17	105	5	40
	KADH2419	19	105	5	40
	KADH2422	22	105	2	16
	KADH2424	24	105	2	16
	KADH2427	27	105	2	16

7PCS

3/8" DR. Star Bit Impact Socket Rail Set



Black Phosphate Finished

ITEM NO.	CONTENTS		10 (SET)
GDAG0703	7 KADA1220-1250 T20, T25, T27, T30, T40, T45, T50		

7PCS

3/8" DR. Hex Bit Impact Socket Rail Set



Black Phosphate Finished

ITEM NO.	CONTENTS		10 (SET)
GDAG0702	7 KADH1204-1212 4, 5, 6, 7, 8, 10, 12 mm		

Impact Sockets, Bit Sockets, Accessories & Air Wrench

1/2" DR. 6PT Flank Thin Wall Deep Impact Sockets with Plastic Sleeves



CR-MO DIN 3121



DRIVE	ITEM NO.	SIZE(mm)	L(mm)	COLOR		
1/2" 12.7mm sq.	KABD1617	17	86	Blue	20	80
	KABD1619	19	86	Yellow	20	80
	KABD1621	21	86	Red	20	80

7PCS

3/8" DR. Hex Bit Impact Socket Set

3/8"



SNCM+V

Black Phosphate Finished

ITEM NO.	GDAI0704
CONTENTS	12 (SET)
7 KADH1204~1212	
○ 3/8" Dr. Hex Bit Impact Sockets	
4, 5, 6, 7, 8, 10, 12 mm	
BLOW CASE: W200 x D105 x H35 (mm)	

7PCS

1/2" DR. Hex Bit Impact Socket Set

1/2"



SNCM+V

Black Phosphate Finished

ITEM NO.	GDAI0702
CONTENTS	18 (SET)
7 KADH1604~1614	
○ 1/2" Dr. Hex Bit Impact Sockets	
4, 5, 6, 8, 10, 12, 14 mm	
BLOW CASE: W250 x D120 x H40 (mm)	

10PCS

1/2" DR. 6PT Flank Impact Socket Set

1/2"



CR-MO

Black Phosphate Finished

ITEM NO.	GDAD1001
CONTENTS	16 (SET)
10 KABA1610~1624	
1/2" Dr. 6PT Flank Impact Sockets	
10, 11, 12, 13, 14, 17, 19, 21, 22, 24 mm	
METAL CASE: W303 x D45 x H47 (mm)	

3PCS

1/2" DR. 6PT Flank Thin Wall Deep Impact Socket Set

1/2"



CR-MO

ITEM NO.	GDAI0301
CONTENTS	20 (SET)
3 KABD1617~1621	
1/2" Dr. 6PT Flank Thin Wall Deep Impact Sockets	
17, 19, 21 mm	
BLOW CASE: W150 x D130 x H50 (mm)	

7PCS

3/8" DR. Star Bit Impact Socket Set

3/8"



SNCM+V

Black Phosphate Finished

ITEM NO.	GDAI0703
CONTENTS	12 (SET)
7 KADA1220~1250	
○ 3/8" Dr. Star Bit Impact Sockets	
T20, T25, T27, T30, T40, T45, T50	
BLOW CASE: W200 x D105 x H35 (mm)	

7PCS

1/2" DR. Star Bit Impact Socket Set

1/2"



SNCM+V

Black Phosphate Finished

ITEM NO.	GDAI0701
CONTENTS	18 (SET)
7 KADA1630~1670	
○ 1/2" Dr. Star Bit Impact Sockets	
T30, T40, T45, T50, T55, T60, T70	
BLOW CASE: W250 x D120 x H40 (mm)	

10PCS

1/2" DR. 6PT Flank Impact Socket Set (SAE)

1/2"



CR-MO

Black Phosphate Finished

ITEM NO.	GEAD1001
CONTENTS	16 (SET)
10 KBBA1614~1632	
1/2" Dr. 6PT Flank Impact Sockets	
7/16", 1/2", 9/16", 5/8", 11/16", 3/4", 13/16", 7/8", 15/16", 1"	
METAL CASE: W303 x D45 x H47 (mm)	

15PCS

1/2" DR. 6PT Flank Impact Socket Set

CR-MO

1/2"



Black Phosphate Finished

ITEM NO.	GDAD1501	6 (SET)
CONTENTS	15 KABA1610~1624 1/2" Dr. 6PT Flank Impact Sockets 10, 11, 12, 13, 14, 15, 16, 17, 18, 19, 20, 21, 22, 23, 24 mm	
METAL CASE: W240 x D110 x H50 (mm)		

14PCS

1/2" DR. 6PT Flank Impact Socket Set

CR-MO

1/2"



Black Phosphate Finished

ITEM NO.	GEAD1401	6 (SET)
CONTENTS	14 KBBA1612~1640 1/2" Dr. 6PT Flank Impact Sockets 3/8", 7/16", 1/2", 9/16", 5/8", 11/16", 3/4", 13/16", 7/8", 15/16", 1", 1-1/16", 1-1/8", 1-1/4"	
METAL CASE: W240 x D110 x H50 (mm)		

12PCS

3/8" DR. 6PT Flank Deep Impact Socket Set

CR-MO

3/8"



Black Phosphate Finished

ITEM NO.	GDAD1201	8 (SET)
CONTENTS	12 KABE1208~1219 3/8" Dr. 6PT Flank Deep Impact Sockets 8, 9, 10, 11, 12, 13, 14, 15, 16, 17, 18, 19 mm	
METAL CASE: W313 x D111 x H38 (mm)		

10PCS

1/2" DR. 6PT Flank Deep Impact Socket Set

CR-MO

1/2"



Black Phosphate Finished

ITEM NO.	GDAD1002	8 (SET)
CONTENTS	10 KABE1610~1624 1/2" Dr. 6PT Flank Deep Impact Sockets 10, 11, 12, 13, 14, 17, 19, 21, 22, 24 mm	
METAL CASE: W313 x D111 x H38 (mm)		

8PCS

3/4" DR. 6PT Flank Impact Socket Set

CR-MO

3/4"



Black Phosphate Finished

ITEM NO.	GDAD0801	4 (SET)
CONTENTS	8 KABA2426~2438 3/4" Dr. 6PT Flank Impact Sockets 26, 27, 29, 30, 32, 35, 36, 38 mm	
METAL CASE: W410 x D64 x H60 (mm)		

8PCS

3/4" DR. 6PT Flank Deep Impact Socket Set

CR-MO

3/4"



Black Phosphate Finished

ITEM NO.	GDAD0802	2 (SET)
CONTENTS	8 KABE2426~2438 3/4" Dr. 6PT Flank Deep Impact Sockets 26, 27, 29, 30, 32, 35, 36, 38 mm	
METAL CASE: W430 x D103 x H70 (mm)		

8PCS

1" DR. 6PT Flank Impact Socket Set

CR-MO

1"



Black Phosphate Finished

ITEM NO.	GDAD0803	3 (SET)
CONTENTS	8 KABA3224~3241 1" Dr. 6PT Flank Impact Sockets 24, 27, 30, 32, 33, 36, 38, 41 mm	
METAL CASE: W278 x D128 x H75 (mm)		

8PCS

1" DR. 6PT Flank Deep Impact Socket Set

CR-MO

1"



Black Phosphate Finished

ITEM NO.	GDAD0804	2 (SET)
CONTENTS	8 KABE3224~3241 1" Dr. 6PT Flank Deep Impact Sockets 24, 27, 30, 32, 33, 36, 38, 41 mm	
METAL CASE: W460 x D128 x H80 (mm)		

Impact Sockets, Bit Sockets, Accessories & Air Wrench

3/8" DR.

Mini Super Duty Air Ratchet Wrench
Rear Exhaust with Muffler



ITEM NO.	KAAE1202	📦 20
SPECIFICATIONS		
Max. Torque	30 ft-lb / 41 Nm	
Free Speed	350 RPM	
Air Pressure	90 PSI / 6.2 BAR	
Air Consumption	2.24 CFM	
Air Inlet	1/4" PT	
Min. Air Hose	5/16" I.D.	
Overall Length	5-13/32" / 128 mm	
Net Weight	0.99 lbs / 0.45 kgs	

3/8" DR.

Mini Super Duty Air Impact Wrench
Handle Exhaust with Muffler



ITEM NO.	KAAG1206	📦 12
SPECIFICATIONS		
Max. Torque	60 ft-lb / 81 Nm	
Free Speed	11000 RPM	
Air Pressure	90 PSI / 6.2 BAR	
Air Consumption	1.76 CFM	
Air Inlet	1/4" PT	
Min. Air Hose	3/8" I.D.	
Overall Length	5-29/32" / 150 mm	
Net Weight	1.56 lbs / 0.71 kgs	

3/8" DR.

Super Duty Air Ratchet Wrench
Rear Exhaust with Muffler



ITEM NO.	KAAF1205	📦 10
SPECIFICATIONS		
Max. Torque	75 ft-lb / 102 Nm	
Free Speed	160 RPM	
Air Pressure	90 PSI / 6.2 BAR	
Air Consumption	3.92 CFM	
Air Inlet	1/4" PT	
Min. Air Hose	5/16" I.D.	
Overall Length	10-1/2" / 266 mm	
Net Weight	2.64 lbs / 1.2 kgs	

3/8" DR.

Super Duty Air Impact Wrench
Impact Mechanism : Jumbo Hammer
Handle Exhaust with Muffler



ITEM NO.	KAAA1220	📦 10
SPECIFICATIONS		
Max. Torque	200 ft-lb / 271 Nm	
Free Speed	10000 RPM	
Air Pressure	90 PSI / 6.2 BAR	
Air Consumption	2.5 CFM	
Air Inlet	1/4" PT	
Min. Air Hose	3/8" I.D.	
Overall Length	5-1/2" / 139 mm	
Net Weight	3.00 lbs / 1.36 kgs	

1/2" DR.

Super Duty Air Ratchet Wrench
Rear Exhaust with Muffler



ITEM NO.	KAAF1605	📦 10
SPECIFICATIONS		
Max. Torque	75 ft-lb / 102 Nm	
Free Speed	160 RPM	
Air Pressure	90 PSI / 6.2 BAR	
Air Consumption	3.92 CFM	
Air Inlet	1/4" PT	
Min. Air Hose	5/16" I.D.	
Overall Length	10-1/2" / 266 mm	
Net Weight	2.64 lbs / 1.2 kgs	

1/2" DR.

Super Duty Air Impact Wrench
Impact Mechanism : Jumbo Hammer
Handle Exhaust with Muffler



MINI DESIGN

LIGHT WEIGHT

Powerful, Lightweight & Short Barrel Model

ITEM NO.	KAAA1650	📦 10
SPECIFICATIONS		
Max. Torque	500 ft-lb / 678 Nm	
Free Speed	10000 RPM	
Air Pressure	90 PSI / 6.2 BAR	
Air Consumption	4.76 CFM	
Air Inlet	1/4" PT	
Min. Air Hose	3/8" I.D.	
Overall Length	4-23/32" / 120 mm	
Net Weight	3.42 lbs / 1.55 kgs	

AIR TOPTUL Impact Wrench

For Automotive Repairs & Maintenance

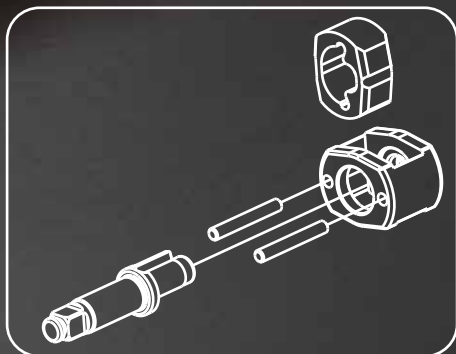
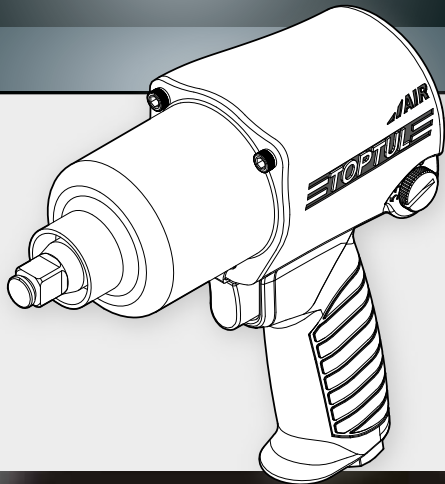

1/2" DR.

Super Duty Air Impact Wrench
Impact Mechanism : New Twin Hammer
Handle Exhaust with Muffler



ITEM NO.	KAAA1660	📦 8
SPECIFICATIONS		
Max. Torque	700 ft-lb / 949 Nm	
Free Speed	6500 RPM	
Air Pressure	90 PSI / 6.2 BAR	
Air Consumption	4.4 CFM	
Air Inlet	1/4" PT	
Min. Air Hose	3/8" I.D.	
Overall Length	7-1/2" / 191 mm	
Net Weight	6.24 lbs / 2.83 kgs	

3/4" DR.

Super Duty Air Impact Wrench
Impact Mechanism : New Twin Hammer
Handle Exhaust with Muffler



ITEM NO.	KAAA2460	📦 8
SPECIFICATIONS		
Max. Torque	600 ft-lb / 813 Nm	
Free Speed	6300 RPM	
Air Pressure	90 PSI / 6.2 BAR	
Air Consumption	4.4 CFM	
Air Inlet	1/4" PT	
Min. Air Hose	3/8" I.D.	
Overall Length	8-5/32" / 207 mm	
Net Weight	6.39 lbs / 2.90 kgs	

1/2" DR.

Super Duty Air Impact Wrench
Impact Mechanism : Jumbo Hammer
Handle Exhaust with Muffler



Powerful, Lightweight & Short Barrel Model

ITEM NO.	KAAC1645	📦 12
SPECIFICATIONS		
Max. Torque	450 ft-lb / 610 Nm	
Free Speed	9600 RPM	
Air Pressure	90 PSI / 6.2 BAR	
Air Consumption	4.9 CFM	
Air Inlet	1/4" PT	
Min. Air Hose	3/8" I.D.	
Overall Length	5-45/64" / 145 mm	
Net Weight	3.48 lbs / 1.58 kgs	

Impact Sockets, Bit Sockets, Accessories & Air Wrench

TOPTUL®

Super Duty Air Impact Wrench

Impact Mechanism : Jumbo Hammer
Handle Exhaust with Muffler

High-performance



KAAC1645

1/2" DR.



**450
FT-LBS**

Powerful, Lightweight & Short Barrel Model

ITEM NO.	KAAC1645
SPECIFICATIONS	
Max. Torque	450 ft-lb / 610 Nm
Free Speed	9600 RPM
Air Pressure	90 PSI / 6.2 BAR
Air Consumption	4.9 CFM
Air Inlet	1/4" PT
Min. Air Hose	3/8" I.D.
Overall Length	5-45/64" / 145 mm
Net Weight	3.48 lbs / 1.58 kgs

12

1/2" DR.

Super Duty Air Impact Wrench
Impact Mechanism : Twin Hammer
Handle Exhaust with Muffler



ITEM NO.	KAAC1660
SPECIFICATIONS  8	
Max. Torque	600 ft-lb / 813 Nm
Free Speed	8000 RPM
Air Pressure	90 PSI / 6.2 BAR
Air Consumption	4.4 CFM
Air Inlet	1/4" PT
Min. Air Hose	3/8" I.D.
Overall Length	7-5/8" / 193 mm
Net Weight	4.69 lbs / 2.13 kgs

3/4" DR.

Super Duty Air Impact Wrench
Impact Mechanism : New Twin Hammer
Handle Exhaust with Muffler



ITEM NO.	KAAC2412
SPECIFICATIONS  4	
Max. Torque	1200 ft-lb / 1626 Nm
Free Speed	6500 RPM
Air Pressure	90 PSI / 6.2 BAR
Air Consumption	6.7 CFM
Air Inlet	3/8" PT
Min. Air Hose	1/2" I.D.
Overall Length	8-55/64" / 225 mm
Net Weight	8.59 lbs / 3.90 kgs

1" DR.

Super Duty Air Impact Wrench
Impact Mechanism : New Twin Hammer
Handle Exhaust with Muffler



ITEM NO.	KAAC3214
SPECIFICATIONS  4	
Max. Torque	1400 ft-lb / 1898 Nm
Free Speed	6500 RPM
Air Pressure	90 PSI / 6.2 BAR
Air Consumption	6.7 CFM
Air Inlet	3/8" PT
Min. Air Hose	1/2" I.D.
Overall Length	9-3/64" / 230 mm
Net Weight	8.94 lbs / 4.06 kgs

1" DR.

Long Anvil Super Duty Air Impact Wrench
Impact Mechanism : Twin Hammer
Side Exhaust with Muffler
Inside Trigger



One of the lightest, most powerful super duty 1" square drive extended anvil impact wrenches. Ultimate torque of 2,000 ft. lbs. at 90 psi. Weighs only 18.34 lbs. Designed for extended use in heavy duty truck tyre service workshops. Twin hammer mechanism promotes an even maximum force on lug nuts or bolts. Features an adjustable 3-position forward and reverse power setting. Auxiliary side handle for ease of control. Rubber comfort grips on both side & back handles.

Powerful & Lightweight Model

ITEM NO.	KAAD3220
SPECIFICATIONS  2	
Max. Torque	2000 ft-lb / 2712 Nm
Free Speed	5000 RPM
Air Pressure	90 PSI / 6.2 BAR
Air Consumption	9 CFM
Air Inlet	1/2" PT
Min. Air Hose	3/4" I.D.
Overall Length	19-31/64" / 495 mm
Net Weight	18.34 lbs / 8.32 kgs



Impact Sockets, Bit Sockets, Accessories & Air Wrench

▣ Straight Air Die Grinder

▣ Air Straight Die Grinder

Professional Grade Air Tools

Powerful 0.6 HP straight-line die grinder for heavy duty applications

Includes two collet chucks: 6mm (Insert) & 1/4"

Adjustable power regulator for precise control

Safety lock lever to prevent accidental start-up

Rear exhaust with muffler directs air away from the workpiece

Suited for grinding, polishing, burnishing and deburring applications



ITEM NO.	KAKA0822	
SPECIFICATIONS		📦 25
Collet Chuck	6mm / 1/4"	
Power	0.6 HP / 0.45 KW	
Free Speed	22000 RPM	
Air Pressure	90 PSI / 6.2 BAR	
Air Consumption	6 CFM	
Air inlet	1/4" PT	
Air Hose	3/8" I.D.	
Overall length	6-9/16" / 167 mm	
weight	1.3 lbs / 0.6 kgs	

▣ Heavy Duty Air Impact Hammer



ITEM NO.	KAHA3217	
SPECIFICATIONS		📦 8
Blow Per Minute	3200 BPM	
Piston Stroke	67mm (2-5/8")	
Chisel Shank Opening (Hex)	10 mm	
Overall Length	171 mm (6-3/4")	
Net Weight	1.6 kg (3.5 lbs)	
Air Inlet	1/4" PT	
Air Hose	3/8" ID	
Air Pressure	90 PSI / 6.2 BAR	
Average Air Consumption	10 CFM (283 l/min)	
Sound Pressure Level	99.8 DBA	
Sound Power Level	110.6 DBA	
Vibration Level	5.1 M/Sec ²	

▣ Flat Chisel

CR-MO



ITEM NO.	Hex(mm)	L(mm)	📦	📦
KAJA18A1	10	178	10	120

▣ Sheet Metal Trimmer

CR-MO



ITEM NO.	Hex(mm)	L(mm)	📦	📦
KAJA18B1	10	178	10	120

▣ Spot Weld Breaker

CR-MO



ITEM NO.	Hex(mm)	L(mm)	📦	📦
KAJA18C1	10	178	10	120

▣ Panel Cutter

CR-MO



ITEM NO.	Hex(mm)	L(mm)	📦	📦
KAJA18D1	10	178	10	120

▣ Taper Punch

CR-MO



ITEM NO.	Hex(mm)	L(mm)	📦	📦
KAJA18E1	10	178	10	120



Hexagon & Star Keys Series Practical

allen and star key wrenches for fastening and releasing screws and fasteners.

HEXAGON & STAR KEYS SERIES





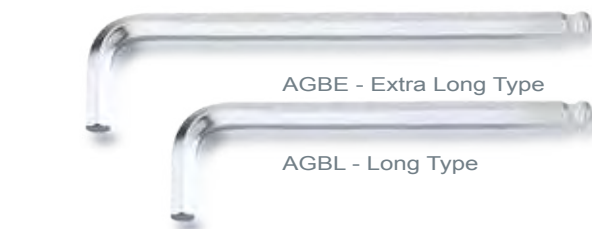
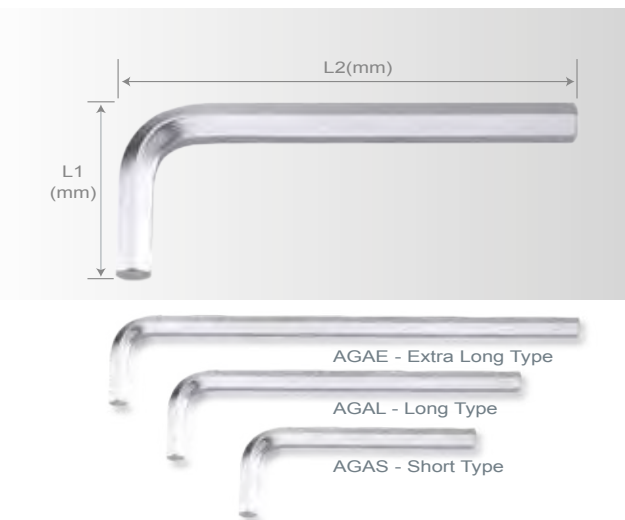

Hexagon & Star Keys



▣ Straight Hex Key Wrenches



AGAE - Extra Long Type



  **SNCM+V Steel** **DIN ISO 2936**

ITEM NO.	SIZE(mm)	L1(mm)	L2(mm)		
AGAE1E09	1.5	15.5	91.5	50	900
AGAE0210	2	18	102	50	400
AGAE2E11	2.5	20.5	114.5	50	400
AGAE0313	3	23	129	50	400
AGAE0414	4	29	144	50	400
AGAE0517	5	33	165	30	360
AGAE0619	6	38	186	20	240
AGAE0720	7	41	197	20	160
AGAE0821	8	44	208	10	80
AGAE1023	10	50	234	10	80
AGAE1226	12	57	262	5	30
AGAE1429	14	70	294	5	30
AGAE1734	17	80	337	5	20
AGAE1938	19	89	379	5	10



▣ Ball End Hex Key Wrenches

AGBE - Extra Long Type



  **DIN ISO 2936**
SNCM+V Steel

ITEM NO.	SIZE(mm)	L1(mm)	L2(mm)		
AGBE1E09	1.5	15.5	91.5	50	900
AGBE0210	2	18	102	50	900
AGBE2E11	2.5	20.5	114.5	50	900
AGBE0313	3	23	129	50	400
AGBE0414	4	29	144	50	400
AGBE0517	5	33	165	30	360
AGBE0619	6	38	186	20	240
AGBE0720	7	41	197	20	160
AGBE0821	8	44	208	15	120
AGBE1023	10	50	234	10	80
AGBE1226	12	57	262	10	60



AGAL - Long Type

ITEM NO.	SIZE(mm)	L1(mm)	L2(mm)		
AGAL1E08	1.5	15.5	78.5	30	540
AGAL0208	2	18	85	30	540
AGAL2E09	2.5	20.5	92.5	30	540
AGAL0310	3	23	101	30	540
AGAL0411	4	29	110	30	480
AGAL0512	5	33	123	30	240
AGAL0614	6	38	143	30	240
AGAL0715	7	41	149	30	240
AGAL0816	8	44	164	20	240
AGAL0917	9	47	165	20	240
AGAL1018	10	50	180	10	120

AGBL - Long Type



ITEM NO.	SIZE(mm)	L1(mm)	L2(mm)		
AGBL1E08	1.5	15.5	78.5	50	900
AGBL0208	2	18	85	50	900
AGBL2E09	2.5	20.5	92.5	50	900
AGBL0310	3	23	101	30	540
AGBL0411	4	28	110	30	480
AGBL0512	5	30	123	30	240
AGBL0614	6	38	143	30	240
AGBL0715	7	41	149	30	240
AGBL0816	8	44	164	20	240
AGBL1018	10	50	180	10	120
AGBL1220	12	57	199	10	80



AGAS - Short Type

ITEM NO.	SIZE(mm)	L1(mm)	L2(mm)		
AGAS1E05	1.5	15.5	46.5	30	540
AGAS0205	2	18	52	30	540
AGAS2E06	2.5	20.5	58.5	30	540
AGAS0307	3	23	66	30	540
AGAS0407	4	29	74	30	240
AGAS0509	5	33	85	30	240
AGAS0610	6	38	96	30	240
AGAS0710	7	41	102	30	240
AGAS0811	8	44	108	25	200
AGAS1012	10	50	122	25	200
AGAS1214	12	57	137	15	120
AGAS1415	14	70	154	5	60
AGAS1718	17	80	177	5	30
AGAS1920	19	89	199	5	30



AHBL - Long Type

  **DIN ISO 2936**
SNCM+V Steel

ITEM NO.	SIZE(inch)	L1(mm)	L2(mm)		
AHBL0208	1/16	15.5	78.5	30	540
AHBL2E08	5/64	18	85	30	540
AHBL0309	3/32	20.5	92.5	30	540
AHBL0410	1/8	23	101	30	540
AHBL0511	5/32	28	110	30	240
AHBL0612	3/16	33	123	30	240
AHBL0814	1/4	38	143	30	240
AHBL1016	5/16	44	164	20	240
AHBL1217	3/8	50	180	10	120

Star Key Wrench

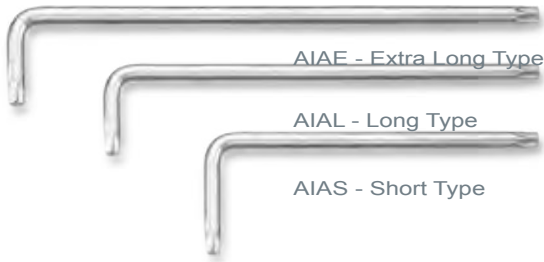

AIAE - Extra Long Type



ITEM NO.	SIZE	L1(mm)	L2(mm)		
AIAE1010	T10	19	91	100	800
AIAE1510	T15	19.5	103.5	70	560
AIAE2011	T20	22	114	60	480
AIAE2513	T25	24.5	129.5	50	400
AIAE2715	T27	29	145	50	400
AIAE3017	T30	34	166	30	360
AIAE4018	T40	39	182	20	240
AIAE4520	T45	44	202	15	120
AIAE5023	T50	49	226	10	80

AIAL - Long Type

ITEM NO.	SIZE	L1(mm)	L2(mm)		
AIAL1007	T10	19	72	30	540
AIAL1508	T15	19.5	83.5	30	540
AIAL2009	T20	23	91	30	540
AIAL2510	T25	24.5	102.5	30	540
AIAL2711	T27	29	113	30	240
AIAL3013	T30	35	126	25	200
AIAL4014	T40	42	142	20	160
AIAL4516	T45	47	161	20	200
AIAL5018	T50	50	182	15	180

AIAS - Short Type

ITEM NO.	SIZE	L1(mm)	L2(mm)		
AIAS1050	T10	19	49	30	540
AIAS1506	T15	19.5	56.5	30	540
AIAS2006	T20	23	62	30	540
AIAS2507	T25	24.5	69.5	30	540
AIAS2708	T27	29	77	30	240
AIAS3009	T30	35	86	30	240
AIAS4010	T40	42	97	30	240
AIAS4511	T45	47	110	25	200
AIAS5012	T50	50	124	25	200

Extra Long Type Star Tamperproof Key Wrench



AIBE - Extra Long Type



ITEM NO.	SIZE	L1(mm)	L2(mm)		
AIBE1009	T10	19	91	100	800
AIBE1510	T15	19.5	103.5	70	560
AIBE2011	T20	22	114	60	480
AIBE2513	T25	24.5	129.5	50	400
AIBE2715	T27	29	145	50	400
AIBE3017	T30	34	166	30	360
AIBE4018	T40	39	182	20	240
AIBE4520	T45	44	202	15	120
AIBE5023	T50	49	226	10	80

7PCS

Long Type Ball Point Hex Key Wrench Set



ITEM NO.	CONTENTS	
GAAL0704	7 2.5, 3, 4, 5, 6, 8, 10 mm	10 (SET)

7PCS

Short Type Star Key Wrench Set



ITEM NO.	CONTENTS	
GAAL0705	7 T10, T15, T20, T25, T27, T30, T40	10 (SET)

TOPTUL hex key wrenches are made of high grade nickel chrome molybdenum alloy steel (SNCM+V tool steel). This premium quality steel is tempered and hardened for maximum hardness and strength. Precision machined hex tips enable full tool engagement in the relevant fixing.



Hexagon & Star Keys

9PCS

Short Type Hex Key Wrench Set



SNCM+V Steel

10 (SET)

ITEM NO. **CONTENTS**
GAAL0910 9 1.5, 2, 2.5, 3, 4, 5, 6, 8, 10 mm

9PCS

Short Type Star Key Wrench Set



SNCM+V Steel

10 (SET)

ITEM NO. **CONTENTS**
GAAL0913 9 T10, T15, T20, T25, T27, T30, T40, T45, T50

9PCS

Long Type Hex Key Wrench Set



SNCM+V Steel

10 (SET)

ITEM NO. **CONTENTS**
GAAL0911 9 1.5, 2, 2.5, 3, 4, 5, 6, 8, 10 mm

9PCS

Long Type Star Key Wrench Set



SNCM+V Steel

10 (SET)

ITEM NO. **CONTENTS**
GAAL0914 9 T10, T15, T20, T25, T27, T30, T40, T45, T50

9PCS

Extra Long Type Hex Key Wrench Set



SNCM+V Steel

10 (SET)

ITEM NO. **CONTENTS**
GAAL0912 9 1.5, 2, 2.5, 3, 4, 5, 6, 8, 10 mm

9PCS

Extra Long Type Star Key Wrench Set



SNCM+V Steel

10 (SET)

ITEM NO. **CONTENTS**
GAAL0924 9 T10, T15, T20, T25, T27, T30, T40, T45, T50

9PCS

Extra Long Type Ball Point Hex Key Wrench Set
 (Short-Arm Hex Key End Type)



Standard arm type
 Short arm type

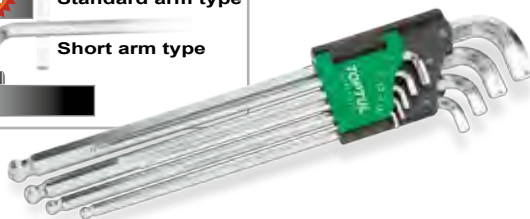

SNCM+V Steel

10 (SET)

ITEM NO. **CONTENTS**
GAAL0922 9 1.5, 2, 2.5, 3, 4, 5, 6, 8, 10 mm

9PCS

Extra Long Type Star Key Wrench Set
 (Short-Arm Star Key End Type)

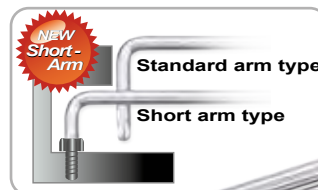

Standard arm type
 Short arm type

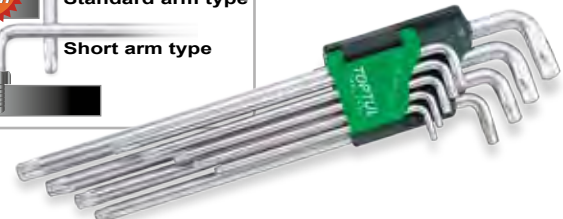

SNCM+V Steel

10 (SET)

ITEM NO. **CONTENTS**
GAAL0923 9 T10, T15, T20, T25, T27, T30, T40, T45, T50

9PCS

Color-Ring Extra Long Type Ball Point Hex Key Wrench Set

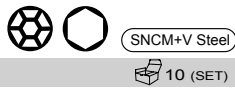

ITEM NO.	CONTENTS
GAAL0918	9 1.5, 2, 2.5, 3, 4, 5, 6, 8, 10 mm

9PCS

Long Type Ball Point Hex Key Wrench Set

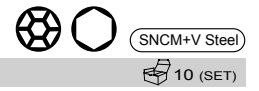

ITEM NO.	CONTENTS
GBAL0901	9 1/16", 5/64", 3/32", 1/8", 5/32", 3/16", 1/4", 5/16", 3/8"

9PCS

Long Type Ball Point Hex Key Wrench Set



ITEM NO.	CONTENTS
GAAL0916	9 1.5, 2, 2.5, 3, 4, 5, 6, 8, 10 mm

9PCS

Long Type Star Tamperproof Key Wrench Set

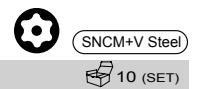

ITEM NO.	CONTENTS
GAAL0919	9 T10, T15, T20, T25, T27, T30, T40, T45, T50

9PCS

Extra Long Type Ball Point Hex Key Wrench Set



ITEM NO.	CONTENTS
GAAL0917	9 1.5, 2, 2.5, 3, 4, 5, 6, 8, 10 mm

9PCS

Extra Long Type Star Tamperproof Key Wrench Set

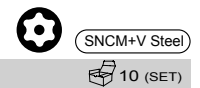

ITEM NO.	CONTENTS
GAAL0915	9 T10, T15, T20, T25, T27, T30, T40, T45, T50

Hexagon & Star Keys

7-in-1 Foldable Hex Key Wrench Set



ITEM NO.	CONTENTS	12
AGFB0703	2.5, 3, 4, 5, 6, 8, 10 mm	

7-in-1 Foldable Hex Key Wrench Set



ITEM NO.	CONTENTS	12
AGFB0701	2, 2.5, 3, 4, 5, 6, 8 mm	

8-in-1 Foldable Star Key Wrench Set



ITEM NO.	CONTENTS	12
AIFB0801	T9, T10, T15, T20, T25, T27, T30, T40	

8-in-1 Foldable Star Key Wrench Set



ITEM NO.	CONTENTS	12
AIFB0802	T6, T7, T8, T9, T10, T15, T20, T25	

T-Type Hex Key Wrench



ITEM NO.	SIZE(mm)	L1(mm)	L2(mm)	12	10
AGDA0213	2	65	125	20	100
AGDAE213	2.5	65	125	20	100
AGDA0313	3	65	125	20	100
AGDAE313	3.5	65	125	20	100
AGDA0418	4	90	180	20	100
AGDAE418	4.5	90	180	20	100
AGDA0518	5	90	180	20	100
AGDA0621	6	105	210	20	100
AGDA0721	7	105	210	20	100
AGDA0825	8	125	250	20	60
AGDA1030	10	145	300	10	40
AGDA1232	12	165	320	10	30
AGDA1434	14	170	340	10	20

9PCS Extra Long Type Hex Key Wrench Set



ITEM NO.	CONTENTS	10 (SET)
GAAD1509	3, 4, 5, 6, 8, 10, 12, 14 mm Knife Type 1.5-6 mm	

METAL CASE: W313 x D103 x H32 (mm)

14PCS Short Type Hex Key Wrench Set



ITEM NO.	CONTENTS	10 (SET)
GPAQ1401	14 2, 2.5, 3, 4, 5, 6, 7, 8, 9, 10, 12, 14, 17, 19 mm	

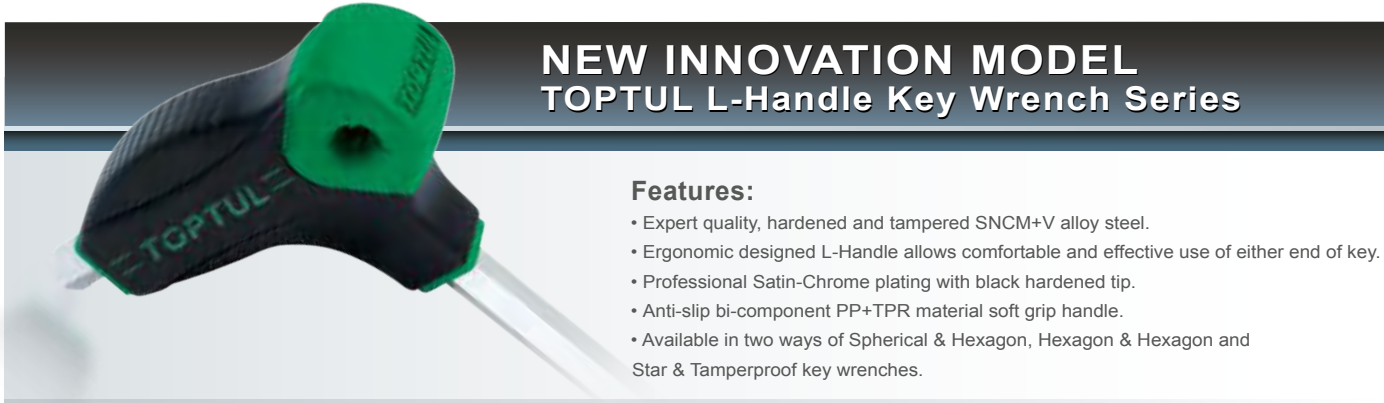

NEW INNOVATION MODEL TOPTUL L-Handle Key Wrench Series

Features:

- Expert quality, hardened and tempered SNCM+V alloy steel.
- Ergonomic designed L-Handle allows comfortable and effective use of either end of key.
- Professional Satin-Chrome plating with black hardened tip.
- Anti-slip bi-component PP+TPR material soft grip handle.
- Available in two ways of Spherical & Hexagon, Hexagon & Hexagon and Star & Tamperproof key wrenches.

▣ L-Type Two Way Magnetic Bit Holder Handle

- Made of Chrome Vanadium Alloy Steel
- 1/4" (H) Magnetic Stainless Steel Bit Holder



ITEM NO.	Hex(inch)	L1(mm)	L2(mm)		
FTFC0820	1/4	118	203	5	30

▣ L-Type Two Way Hex Key Wrench

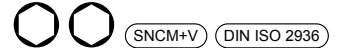
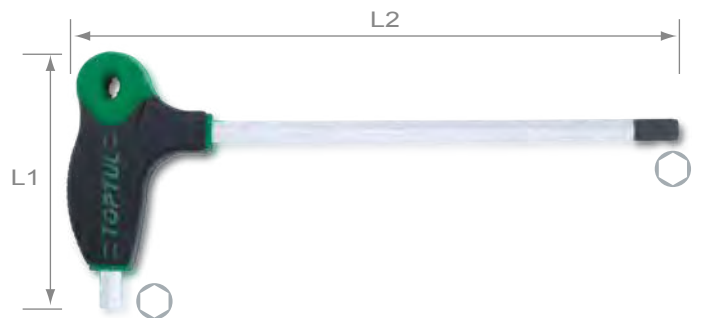

ITEM NO.	SIZE(mm)	L1(mm)	L2(mm)		
AGHD0214	2	77	140	5	80
AGHD2E14	2.5	77	140	5	80
AGHD0314	3	77	140	5	80
AGHD0414	4	77	140	5	80
AGHD0520	5	97	203	5	40
AGHD0620	6	97	203	5	40
AGHD0720	7	97	203	5	40
AGHD0827	8	116	265	5	30
AGHD1027	10	116	265	5	30
AGHD1227	12	116	265	5	30

▣ L-Type Two Way Driver Handle

- Made of Chrome Vanadium Alloy Steel
- Easy to use L-handle tools allow to use any 1/4" square drive attachments such as sockets, hex drives and etc.



ITEM NO.	DRIVE(inch)	L1(mm)	L2(mm)		
AFAU0827	1/4	116	265	5	30

▣ L-Type Two Way Ball Point & Hex Key Wrench

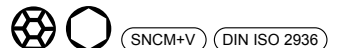
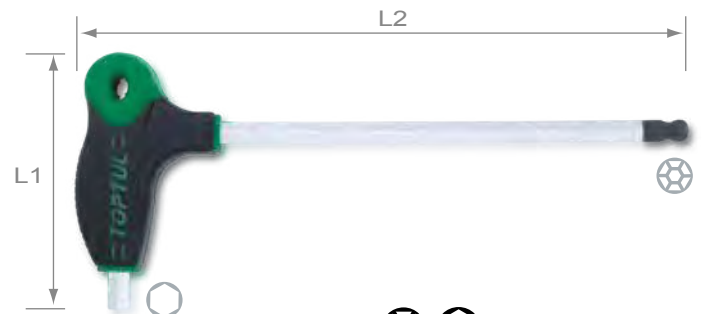

ITEM NO.	SIZE(mm)	L1(mm)	L2(mm)		
AGCD0214	2	77	140	5	80
AGCD2E14	2.5	77	140	5	80
AGCD0314	3	77	140	5	80
AGCD0414	4	77	140	5	80
AGCD0520	5	97	203	5	40
AGCD0620	6	97	203	5	40
AGCD0720	7	97	203	5	40
AGCD0827	8	116	265	5	30
AGCD1027	10	116	265	5	30

Hexagon & Star Keys

9PCS

L-Type Two Way Star & Tamperproof Key Wrench Set



ITEM NO.	GZC0904	(SNCM+V)
CONTENTS	5 (SET)	
9 AIED1014~AIED5027 L-Type Two Way Star & Tamperproof Key Wrenches T10x140, T15x140, T20x140, T25x140, T27x203, T30x203, T40x203, T45x265, T50x265		
PLASTIC BOX: W373 x D289 x H56 (mm)		

9PCS

L-Type Two Way Star & Tamperproof Key Wrench Set



ITEM NO.	CONTENTS	9 (SET)
GAAX0901	9 T10, T15, T20, T25, T27, T30, T40, T45, T50	

9PCS

L-Type Two Way Hex Key Wrench Set



ITEM NO.	GZC0906	(SNCM+V)
CONTENTS	5 (SET)	
9 AGHD0214~AGHD1027 L-Type Two Way Hex Key Wrenches 2x140, 2.5x140, 3x140, 4x140, 5x203, 6x203, 7x203, 8x265, 10x265 mm		
PLASTIC BOX: W373 x D289 x H56 (mm)		

8PCS

L-Type Two Way Ball Point & Hex Key Wrench Set



ITEM NO.	CONTENTS	9 (SET)
GAAX0801	8 2, 2.5, 3, 4, 5, 6, 8, 10 mm	

9PCS

L-Type Two Way Ball Point & Hex Key Wrench Set

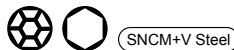

ITEM NO.	GZC0903	(SNCM+V Steel)
CONTENTS	5 (SET)	
9 AGCD0214~AGCD1027 L-Type Two Way Ball Point & Hex Key Wrenches 2x140, 2.5x140, 3x140, 4x140, 5x203, 6x203, 7x203, 8x265, 10x265 mm		
PLASTIC BOX: W373 x D289 x H56 (mm)		

8PCS

L-Type Two Way Hex Key Wrench Set



ITEM NO.	CONTENTS	9 (SET)
GAAX0802	8 2, 2.5, 3, 4, 5, 6, 8, 10 mm	

■ L-Type Two Way Ball Point & Hex Key Wrench



ITEM NO.	SIZE(mm)	L1(mm)	L2(mm)		
AGCA0215	2	74	147	5	80
AGCA2E15	2.5	74	147	5	80
AGCA0315	3	74	147	5	80
AGCA0415	4	74	147	5	80
AGCA0521	5	94	212	5	40
AGCA0621	6	94	212	5	40
AGCA0828	8	115	281	5	30
AGCA1028	10	115	281	5	30

■ 6PCS

Two Way Ball Point & Hex Key Wrench Set



ITEM NO.	CONTENTS	
GAAS0601	6 2, 2.5, 3, 4, 5, 6 mm	10 (SET)

■ L-Type Two Way Star & Tamperproof Key Wrench



ITEM NO.	SIZE	L1(mm)	L2(mm)		
AIEA1015	T10	74	147	5	60
AIEA1515	T15	74	147	5	60
AIEA2015	T20	74	147	5	60
AIEA2515	T25	74	147	5	60
AIEA3021	T30	94	212	5	40
AIEA4021	T40	94	212	5	40

■ 6PCS

Two Way Star & Tamperproof Key Wrench Set



ITEM NO.	CONTENTS	
GAAS0602	6 T10, T15, T20, T25, T30, T40	10 (SET)

■ T-Type Hex Key Wrench

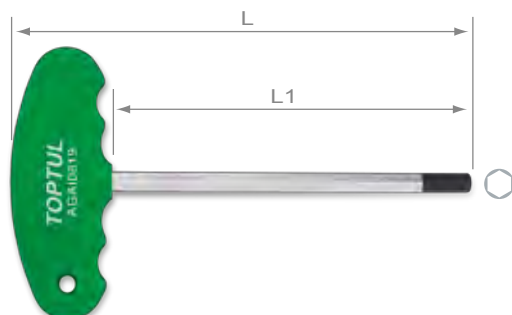

ITEM NO.	SIZE(mm)	L1(mm)	L(mm)		
AGAI0219	2	150	186	10	60
AGAI2E19	2.5	150	186	10	60
AGAI0319	3	150	186	10	60
AGAI0419	4	150	186	10	60
AGAI0519	5	150	188	8	48
AGAI0619	6	150	188	8	48
AGAI0819	8	150	190	8	48
AGAI1019	10	150	190	8	48



Screwdrivers, Bits & Power Bits Series

The

conventional equipment contains Phillips, Slotted, Pozidriv & Star Tamperproof types.

SCREWDRIVERS, BITS & POWER BITS SERIES



110

Precision Slotted Screwdrivers



TYPE	ITEM NO.	SIZE(mm)	L1(mm)	L(mm)		
	FAIB1B05	1.2	50	140	10	80
	FAIB1E05	1.5	50	140	10	80
	FAIB0205	2	50	140	10	80
	FAIB2E05	2.5	50	140	10	80
	FAIB0305	3	50	140	10	80

Precision Phillips Screwdrivers



TYPE	ITEM NO.	SIZE	L1(mm)	L(mm)		
	FBIB1005	PH0	50	140	10	80
	FBIB2005	PH00	50	140	10	80
	FBIB3005	PH000	50	140	10	80

Precision Star Screwdrivers



TYPE	ITEM NO.	SIZE	L1(mm)	L(mm)		
	FFIB0505	T5	50	140	10	80
	FFIB0605	T6	50	140	10	80
	FFIB0705	T7	50	140	10	80
	FFIB0805	T8	50	140	10	80
	FFIB0905	T9	50	140	10	80
	FFIB1005	T10	50	140	10	80
	FFIB1505	T15	50	140	10	80
	FFIB2005	T20	50	140	10	80

8PCS

14-In-1 Precision Screwdriver Set



ITEM NO.	CONTENTS		
GAAW0804	4 T6xT10, T7xT15, T8xT20, T9xT25 3 x #00x2, #0x3, #1x4 1 Screwdriver handle	10 (SET)	

8PCS

Precision Screwdriver Set (Star Type)



ITEM NO.	CONTENTS		
GAAW0801	8 FFIB0505~2005 Precision Star Screwdrivers T5x50, T6x50, T7x50, T8x50, T9x50, T10x50, T15x50, T20x50	10 (SET)	

8PCS

Precision Screwdriver Set (Slotted & Phillips Type)



ITEM NO.	CONTENTS		
GAAW0802	5 FAIB1B05~0305 Precision Slotted Screwdrivers 1.2x50, 1.5x50, 2x50, 2.5x50, 3x50 3 FBIB1005~3005 Precision Phillips Screwdrivers PH0x50, PH00x50, PH000x50	10 (SET)	

8PCS

Precision Screwdriver Set (Slotted, Phillips & Star Type)



ITEM NO.	CONTENTS		
GAAW0803	3 FAIB1E05~0305 Precision Slotted Screwdrivers 1.5x50, 2x50, 3x50 3 FBIB1005~3005 Precision Phillips Screwdrivers PH0x50, PH00x50, PH000x50 2 FFIB1505 & 2005 Precision Star Screwdrivers T15x50 & T20x50	10 (SET)	

TOPTUL
PRECISION SCREWDRIVERS SERIES

Screwdrivers, Bits & Power Bits

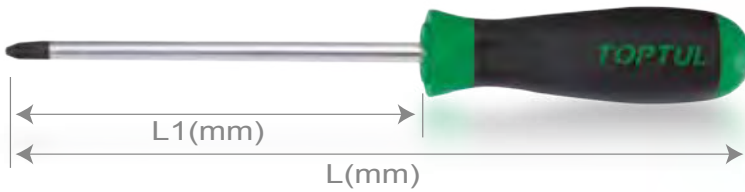

Stubby Slotted Anti-Slip Screwdrivers

Expert quality, specially hardened and tempered SNCM+V Steel round blade
High performance black hardened, magnetic tip
PP+TPR material non-slippery grip handle



TYPE	ITEM NO.	SIZE(mm)	L1(mm)	L(mm)		
	FABB0403	4.0	25	85	5	80
	FABB5E03	5.5	25	85	5	80
	FABB6E03	6.5	25	85	5	80

Stubby Phillips Anti-Slip Screwdrivers

Expert quality, specially hardened and tempered SNCM+V Steel round blade
High performance black hardened, magnetic tip
PP+TPR material non-slippery grip handle



TYPE	ITEM NO.	SIZE	L1(mm)	L(mm)		
	FBBB0103	PH1	25	85	5	80
	FBBB0203	PH2	25	85	5	80

Stubby Pozidriv Anti-Slip Screwdrivers

Professional S2 Alloy Steel round blade
High performance black hardened, magnetic tip
PP+TPR material non-slippery grip handle



TYPE	ITEM NO.	SIZE	L1(mm)	L(mm)		
	FCBB0103	PZ1	25	85	5	80
	FCBB0203	PZ2	25	85	5	80

Phillips Anti-Slip Screwdrivers

Expert quality, specially hardened and tempered SNCM+V Steel round blade
High performance black hardened, magnetic tip
PP+TPR material non-slippery grip handle



TYPE	ITEM NO.	SIZE	L1(mm)	L(mm)		
	FBAB0006	PH0	60	147	5	40
	FBAB0108	PH1	80	185	5	40
	FBAB0110	PH1	100	205	5	40
	FBAB0210	PH2	100	215	5	40
	FBAB0215	PH2	150	265	5	40
	FBAB0220	PH2	200	315	5	30
	FBAB0315	PH3	150	275	5	40

Slotted Anti-Slip Screwdrivers

Expert quality, specially hardened and tempered SNCM+V Steel round blade
High performance black hardened, magnetic tip
PP+TPR material non-slippery grip handle



TYPE	ITEM NO.	SIZE(mm)	L1(mm)	L(mm)		
	FAAB0308	3.0	75	162	5	40
	FAAB3E10	3.5	100	187	5	40
	FAAB0410	4.0	100	205	5	40
	FAAB0510	5.0	100	205	5	40
	FAAB5E10	5.5	100	215	5	40
	FAAB5E15	5.5	150	265	5	40
	FAAB6E10	6.5	100	215	5	40
	FAAB6E15	6.5	150	265	5	40
	FAAB6E20	6.5	200	315	5	30
	FAAB0818	8.0	175	300	5	40
	FAAB1020	10.0	200	325	5	30

Pozidriv Anti-Slip Screwdrivers

Professional S2 Alloy Steel round blade
High performance black hardened, magnetic tip
PP+TPR material non-slippery grip handle



TYPE	ITEM NO.	SIZE	L1(mm)	L(mm)		
	FCAB0006	PZ0	60	147	5	40
	FCAB0108	PZ1	80	185	5	40
	FCAB0210	PZ2	100	215	5	40
	FCAB0315	PZ3	150	275	5	40

Star Anti-Slip Screwdrivers

Professional S2 Alloy Steel round blade
High performance black hardened, magnetic tip
PP+TPR material non-slippery grip handle



TYPE	ITEM NO.	SIZE	L1(mm)	L(mm)		
	FFAB0808	T8	75	162	5	40
	FFAB0908	T9	75	162	5	40
	FFAB1008	T10	75	162	5	40
	FFAB1508	T15	75	180	5	40
	FFAB2010	T20	100	205	5	40
	FFAB2510	T25	100	215	5	40
	FFAB2710	T27	100	215	5	40
	FFAB3013	T30	125	240	5	40
	FFAB4015	T40	150	275	5	40



Slotted Anti-Slip Screwdrivers

Expert quality, specially hardened and tempered SNCM+V steel round blade
High performance black hardened, magnetic tip
Precision-machined parallel faces enables flush contact with the sides of the slot in the screw head
PP+TPR material non-slippery grip handle



TYPE	ITEM NO.	SIZE(mm)	L1(mm)	L(mm)		
	FNAB2E08	2.5	75	162	5	40
	FNAB0308	3.0	75	162	5	40
	FNAB3E10	3.5	100	187	5	40
	FNAB3E15	3.5	150	237	5	40
	FNAB0415	4.0	150	255	5	40

Star Tamperproof Anti-Slip Screwdrivers

Professional S2 Alloy Steel round blade
High performance black hardened, magnetic tip
PP+TPR material non-slippery grip handle



TYPE	ITEM NO.	SIZE	L1(mm)	L(mm)		
	FEAB0808	T8	75	162	5	40
	FEAB0908	T9	75	162	5	40
	FEAB1008	T10	75	162	5	40
	FEAB1508	T15	75	180	5	40
	FEAB2010	T20	100	205	5	40
	FEAB2510	T25	100	215	5	40
	FEAB2710	T27	100	215	5	40
	FEAB3013	T30	125	240	5	40
	FEAB4015	T40	150	275	5	40

Extra Long Slotted Anti-Slip Screwdrivers

Expert quality, specially hardened and tempered SNCM+V Steel round blade
High performance black hardened, magnetic tip
PP+TPR material non-slippery grip handle



TYPE	ITEM NO.	SIZE(mm)	L1(mm)	L(mm)		
	FACB0440	4.0	400	505	5	10
	FACB5E40	5.5	400	515	5	10
	FACB6E25	6.5	250	365	5	30
	FACB6E30	6.5	300	415	5	10
	FACB6E40	6.5	400	515	5	10

Extra Long Phillips Anti-Slip Screwdrivers

Expert quality, specially hardened and tempered SNCM+V Steel round blade
High performance black hardened, magnetic tip
PP+TPR material non-slippery grip handle



TYPE	ITEM NO.	SIZE	L1(mm)	L(mm)		
	FBCB0125	PH1	250	355	5	30
	FBCB0140	PH1	400	505	5	10
	FBCB0225	PH2	250	365	5	30
	FBCB0230	PH2	300	415	5	10
	FBCB0240	PH2	400	515	5	10

3PCS

Extra Long Slotted & Phillips Super-Grip Screwdriver Set



ITEM NO.	CONTENTS	
GAAE0306	2 FACB5E40 & 6E40 Extra Long Slotted Anti-Slip Screwdrivers 5.5x400 & 6.5x400	8 (SET)
	1 FBCB0240 Extra Long Phillips Anti-Slip Screwdriver PH2x400	

Screwdrivers, Bits & Power Bits

Slotted Anti-Slip Screwdrivers

(Hexagon Steel & Hexagon Driver)

Expert quality, specially hardened and tempered SNCM+V Steel hexagonal blade
Strong grip on blade with hex shoulder to use on a wrench for extra leverage
High performance black hardened, magnetic tip
PP+TPR material non-slippery grip handle



TYPE	ITEM NO.	SIZE(mm)	L1(mm)	L(mm)		
	FAHB5E10	5.5	100	205	5	40
	FAHB6E15	6.5	150	265	5	40
	FAHB0818	8	175	300	5	40
	FAHB1020	10	200	325	5	30

Phillips Anti-Slip Screwdrivers

(Hexagon Steel & Hexagon Driver)

Expert quality, specially hardened and tempered SNCM+V Steel hexagonal blade
Strong grip on blade with hex shoulder to use on a wrench for extra leverage
High performance black hardened, magnetic tip
PP+TPR material non-slippery grip handle



TYPE	ITEM NO.	SIZE	L1(mm)	L(mm)		
	FBHB0108	PH1	75	180	5	40
	FBHB0210	PH2	100	215	5	40
	FBHB0315	PH3	150	275	5	40

Go-Thru Slotted Screwdrivers

(Hexagon Steel & Hexagon Driver)

Expert quality, specially hardened and tempered SNCM+V Steel hexagonal blade
Strong grip on blade with hex shoulder to use on a wrench for extra leverage
High performance black hardened, magnetic tip
PP+TPR material non-slippery grip handle



TYPE	ITEM NO.	SIZE(mm)	L1(mm)	L(mm)		
	FAGB5E10	5.5	100	215	5	40
	FAGB6E15	6.5	150	265	5	40
	FAGB0818	8	175	300	5	40
	FAGB1020	10	200	325	5	30

Go-Thru Phillips Screwdrivers

(Hexagon Steel & Hexagon Driver)

Expert quality, specially hardened and tempered SNCM+V Steel hexagonal blade
Strong grip on blade with hex shoulder to use on a wrench for extra leverage
High performance black hardened, magnetic tip
PP+TPR material non-slippery grip handle



TYPE	ITEM NO.	SIZE	L1(mm)	L(mm)		
	FBGB0108	PH1	75	190	5	40
	FBGB0210	PH2	100	215	5	40
	FBGB0315	PH3	150	275	5	40

Flexible Spinner Handle

Chrome Vanadium Steel
Extra harden and high durability
Anti-slip ergonomic designed handle



ITEM NO.	DRIVE(inch)	L1(mm)	L(mm)		
CASP0829	1/4	175	290	10	40

Flexible Bit Holder with Handle

Chrome Vanadium Steel
Extra harden and high durability
Anti-slip ergonomic designed handle



ITEM NO.	HEX(inch)	L1(mm)	L(mm)		
FTCA0829	1/4	175	290	10	40

Magnetic Bit Holder with Handle

Chrome Vanadium Steel
Extra hardened and high durability
Anti-slip ergonomic designed handle



ITEM NO.	HEX(inch)	L1(mm)	L(mm)		
FTBA0824	1/4	125	240	10	40

Nutspinner

Chrome Vanadium Steel
Extra harden and high durability
Anti-slip ergonomic designed handle



ITEM NO.	SIZE(mm)	L1(mm)	L(mm)		
FGAB0413	4	125	230	10	40
FGAB0513	5	125	230	10	40
FGAB0613	6	125	230	10	40
FGAB0713	7	125	230	10	40
FGAB0813	8	125	240	10	40
FGAB0913	9	125	240	10	40
FGAB1013	10	125	240	10	40
FGAB1113	11	125	250	10	40
FGAB1213	12	125	250	10	40
FGAB1313	13	125	250	10	40

58PCS Professional Grade
Professional Screwdriver & Bit Set



ITEM NO.	GAAI5801
CONTENTS	3 (SET)
<p>3 FAIB0205-0305 Slotted Precision Screwdrivers 2, 2.5, 3 mm</p> <p>2 FBIB1005 & 2005 Phillips Precision Screwdrivers PH0 & PH00</p> <p>3 FFIB1005-2005 Star Precision Screwdrivers T10, T15, T20</p> <p>2 FABB5E03 & 6E03 Stubby Slotted Anti-Slip Screwdrivers 5.5 & 6.5 mm</p> <p>2 FBBB0103 & 0203 Stubby Phillips Anti-Slip Screwdrivers PH1 & PH2</p> <p>4 FBAB0006-0315 Phillips Anti-Slip Screwdrivers PH0, PH1, PH2, PH3</p> <p>4 FAAB0410-0818 Slotted Anti-Slip Screwdrivers 4, 5.5, 6.5, 8 mm</p> <p>5 FSA0803-0808 1/4" Hex Shank Slotted Insert Bits 3, 4, 5.5, 6.5, 8 mm</p> <p>4 FSBA0800-0803 1/4" Hex Shank Phillips Insert Bits PH0, PH1, PH2, PH3</p> <p>4 FSCA0800-0803 1/4" Hex Shank Pozi Insert Bits PZ0, PZ1, PZ2, PZ3</p> <p>7 FSDA0802-0808 1/4" Hex Shank Hexagon Insert Bits 2, 2.5, 3, 4, 5, 6, 8 mm</p> <p>7 FSEA0810-0840 1/4" Hex Shank Star Insert Bits T10, T15, T20, T25, T27, T30, T40</p> <p>7 FSGA0810-0840 1/4" Hex Shank Star Tamperproof Insert Bits T10, T15, T20, T25, T27, T30, T40</p> <p>1 FTCA0829 1/4" (H) Flexible Bit Holder with Handle</p> <p>1 FTBA0824 1/4" (H) Magnetic Bit Holder with Handle</p> <p>1 FAJA0315 Voltage Tester, GS/CE Approval - 140mm (L)</p> <p>1 FTDC0808 1/4" (H) Magnetic Power Bit Holder</p>	
BLOW CASE: W478 x D234 x H100 (mm)	



20PCS
Professional Screwdriver & Bit Set



ITEM NO.	GZC2005
CONTENTS	5 (SET)
<p>4 FAAB0308-6E15 Slotted Anti-Slip Screwdrivers 3.0x75, 3.5x100, 4.0x100, 6.5x150</p> <p>1 FABB5E03 Stubby Slotted Anti-Slip Screwdriver 5.5x25</p> <p>1 FAGB0818 Go-Thru Slotted Screwdriver (Hexagon Steel & Hexagon Driver) - 8x175</p> <p>3 FBAB0006-0210 Phillips Anti-Slip Screwdrivers PH0x60, PH1x80, PH2x100</p> <p>1 FBBB0203 Stubby Phillips Anti-Slip Screwdriver PH2x25</p> <p>1 FCAB0210 Pozi driv Anti-Slip Screwdriver PZ2x100</p> <p>1 FJAB0213 Square Anti-Slip Screwdriver SQ2x125</p> <p>1 FTEA0806 1/4" (Hex) Reversible Ratchet Screwdriver</p> <p>7 GAAV0701 1/4" Hex Screwdriver Bit Set 2, 2.5, 3, 4, 5, 6, 8 mm</p>	
PLASTIC BOX: W373 x D289 x H56 (mm)	

14PCS
Slotted & Phillips Screwdriver Set



ITEM NO.	GZC1401
CONTENTS	5 (SET)
<p>4 FAAB0308-5E15 Slotted Anti-Slip Screwdrivers 3.0x75, 3.5x100, 4.0x100, 5.5x150</p> <p>2 FAHB6E15 & 0818 Slotted Anti-Slip Screwdrivers (Hexagon Steel & Hexagon Driver) 6.5x150 & 8.0x175</p> <p>2 FABB5E03 & 6E03 Stubby Slotted Anti-Slip Screwdrivers 5.5x25 & 6.5x25</p> <p>2 FBAB0006 & 0108 Phillips Anti-Slip Screwdrivers PH0x60 & PH1x80</p> <p>2 FBHB0210 & 0315 Phillips Anti-Slip Screwdrivers (Hexagon Steel & Hexagon Driver) PH2x100 & PH3x150</p> <p>2 FBBB0103 & 0203 Stubby Phillips Anti-Slip Screwdrivers PH1x25 & PH2x25</p>	
PLASTIC BOX: W373 x D289 x H56 (mm)	

Screwdrivers, Bits & Power Bits

4PCS

Phillips Super-Grip Screwdriver Set



ITEM NO.	CONTENTS	20 (SET)
GAAE0401	4 FBAB0006-0315 Phillips Anti-Slip Screwdrivers PH0x60, PH1x80, PH2x100, PH3x150	

5PCS

Slotted Super-Grip Screwdriver Set



ITEM NO.	CONTENTS	20 (SET)
GAAE0503	5 FAAB0308-6E15 Slotted Anti-Slip Screwdrivers 3x75, 3.5x100, 4x100, 5.5x100, 6.5x150	

5PCS

Slotted & Phillips Super-Grip Screwdriver Set



ITEM NO.	CONTENTS	20 (SET)
GAAE0504	3 FAAB5E10-0818 Slotted Anti-Slip Screwdrivers 5.5x100, 6.5x150, 8x175 2 FBAB0108 & 0210 Phillips Anti-Slip Screwdrivers PH1x80 & PH2x100	

6PCS

Go-Thru Slotted & Phillips Screwdriver Set
(Hexagon Steel & Driver)



ITEM NO.	CONTENTS	20 (SET)
GAAE0605	4 FAGB5E10-1020 Go-Thru Slotted Screwdrivers (Hexagon Steel & Hexagon Driver) 5.5x100, 6.5x150, 8x175, 10x200 2 FBGB0108 & 0210 Go-Thru Phillips Screwdrivers (Hexagon Steel & Hexagon Driver) PH1x75 & PH2x100	

6PCS

Go-Thru Slotted & Phillips Screwdriver Set
(Hexagon Steel & Driver)



ITEM NO.	CONTENTS	20 (SET)
GAAE0613	3 FAGB5E10-0818 Go-Thru Slotted Screwdrivers (Hexagon Steel & Hexagon Driver) 5.5x100, 6.5x150, 8x175 3 FBGB0108-0315 Go-Thru Phillips Screwdrivers (Hexagon Steel & Hexagon Driver) PH1x75, PH2x100, PH3x150	

TOPTUL

SUPER-GRIP SCREWDRIVER SERIES

6PCS
Slotted & Phillips Super-Grip Screwdriver Set



ITEM NO.	CONTENTS	20 (SET)
GAAE0611	3 FAAB0410-1020	20 (SET)
	Slotted Anti-Slip Screwdrivers 4x100, 6.5x150, 10x200	
	3 FBAB0108-0315 Phillips Anti-Slip Screwdrivers PH1x80, PH2x100, PH3x150	

6PCS
Super-Grip Star Tamperproof Screwdriver Set



ITEM NO.	CONTENTS	20 (SET)
GAAE0610	6 FEAB1008-4015	20 (SET)
	Star Tamperproof Anti-Slip Screwdrivers T10x75, T15x75, T20x100, T25x100, T30x125, T40x150	

6PCS
Slotted & Pozidriv Super-Grip Screwdriver Set



ITEM NO.	CONTENTS	20 (SET)
GAAE0604	4 FAAB0308-6E15	20 (SET)
	Slotted Anti-Slip Screwdrivers 3x75, 4x100, 5.5x100, 6.5x150	
	2 FCAB0108 & 0210 Pozidriv Anti-Slip Screwdrivers PZ1x80 & PZ2x100	

8PCS
Slotted & Phillips Super-Grip Screwdriver Set



ITEM NO.	CONTENTS	20 (SET)
GAAE0807	5 FAAB3E10-0818	20 (SET)
	Slotted Anti-Slip Screwdrivers 3.5x100, 4x100, 5.5x100, 6.5x150, 8x175	
	3 FBAB0006-0210 Phillips Anti-Slip Screwdrivers PH0x60, PH1x80, PH2x100	

6PCS
Slotted & Phillips Super-Grip Screwdriver Set
(Hexagon Steel & Driver)



ITEM NO.	CONTENTS	20 (SET)
GAAE0608	4 FAHB5E10-1020	20 (SET)
	Slotted Anti-Slip Screwdrivers (Hexagon Steel & Hexagon Driver) 5.5x100, 6.5x150, 8x175, 10x200	
	2 FBHB0108 & 0210 Phillips Anti-Slip Screwdrivers (Hexagon Steel & Hexagon Driver) PH1x75 & PH2x100	

11PCS
Slotted & Phillips Super-Grip Screwdriver Set



ITEM NO.	CONTENTS	10 (SET)
GAAE1101	7 FAAB0308-1020	10 (SET)
	Slotted Anti-Slip Screwdrivers 3x75, 3.5x100, 4x100, 5.5x100, 6.5x150, 8x175, 10x200	
	4 FBAB0006-0315	
	Phillips Anti-Slip Screwdrivers PH0x60, PH1x80, PH2x100, PH3x150	

Screwdrivers, Bits & Power Bits

VDE Insulated

1. Black Hardened Magnetic Tip extends product service life and facilitates picking up fasteners.
2. Expert quality, SNCM+V Alloy Steel enables "High Strength" blade performance.
3. Blade insulation meets VDE and international standard DIN EN/IEC 60900
4. Ergonomic Designed Handle provides optimum comfort in use especially for high torque tightening and loosening works.



Expert quality, specially hardened and tempered SNCM+V Steel round blade
Blade insulation meets VDE and international standard DIN EN/IEC 60900
High performance black hardened, magnetic tip
PP+TPR material non-slip handle

☐ VDE Insulated Slotted Screwdrivers



TYPE	ITEM NO.	SIZE(mm)	L1(mm)	L(mm)		
	FAEB0308	3	75	162	5	40
	FAEB0410	4	100	205	5	40
	FAEB5E13	5.5	125	240	5	40
	FAEB6E15	6.5	150	265	5	40
	FAEB0818	8	175	300	5	40

☐ 7PCS VDE Insulated Screwdriver Set



☐ VDE Insulated Phillips Screwdrivers



TYPE	ITEM NO.	SIZE	L1(mm)	L(mm)		
	FBEB0008	PH0	75	162	5	40
	FBEB0110	PH1	100	205	5	40
	FBEB0210	PH2	100	215	5	40
	FBEB0315	PH3	150	275	5	40

☐ VDE Insulated Pozidriv Screwdrivers



TYPE	ITEM NO.	SIZE	L1(mm)	L(mm)		
	FCBE0008	PZ0	75	162	5	40
	FCBE0110	PZ1	100	205	5	40
	FCBE0210	PZ2	100	215	5	40
	FCBE0315	PZ3	150	275	5	40

ITEM NO.	CONTENTS		8 (SET)
GAAE0704	3 FAEB0410-6E15		VDE Insulated Slotted Screwdrivers 4x100, 5.5x125, 6.5x150
	3 FBEB0110-0315		
		VDE Insulated Phillips Screwdrivers PH1x100, PH2x100, PH3x150	
		1 FAJA0315 - Voltage Tester, GS/CE Approval - 140mm (L) (Voltage Range 110-250V/AC)	



8 (SET)

TOPTUL High-Torque Ratchet Screwdriver Series

9-In-1

High-Torque Stubby Ratchet Screwdriver Set

- Quick change 1/4" hex shank bit holder
- 3 position, 36 tooth ratcheting action: Forward / Lock / Reverse
- High torque performance over 350 kgf-cm
- Rigid one piece all stainless steel construction, strong magnetic extension bit holder ensures both bits and screws firmly attached to the driver
- Textured non-slip, bi-component PP+TPR plastic handles

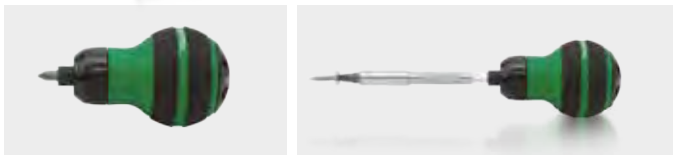

ITEM NO.	GAAR1101	10 (SET)
CONTENTS		
1	FTED0817	1/4" (H) High-Torque Stubby Ratchet Screwdriver Handle with Storage (85mm)
1	FTDB0810	1/4" Hex Shank Extension Magnetic Bit Holder (95mm)
3	FSAA0804-086E	1/4" Hex Shank Slotted Insert Bits 4, 5.5, 6.5 (25mm)
2	FSBA0801 & 0802	1/4" Hex Shank Phillips Insert Bits PH1 & PH2 (25mm)
3	FSEA0815-0825	1/4" Hex Shank Star Insert Bits T15, T20, T25 (25mm)
1	FSKA0808	1/4" Hex Shank Socket Adaptor 1/4" x 1/4" (25mm)

8-In-1

High-Torque Pistol Grip Ratchet Screwdriver Set

- Magnetic 1/4" hex shank bit holder
- 3 position, 20 tooth ratcheting action: Forward / Lock / Reverse
- High torque performance over 400 kgf-cm
- Adjustable handle (Pistol grip & Straight handle)
- Durable & comfortable bi-component plastic handle
- Includes 7 pieces S2 steel insert bits and one socket adaptor. Internal bit storage (end cap carries 7 bits)



ITEM NO.	GAAR0901	10 (SET)
CONTENTS		
1	FTEG0820	1/4" (H) High-Torque Pistol Grip Ratchet Screwdriver Handle with Storage (200mm)
4	FSAA0804-0808	1/4" Hex Shank Slotted Insert Bits 4, 5.5, 6.5, 8 mm (25mm)
3	FSBA0801-0803	1/4" Hex Shank Phillips Insert Bits PH1, PH2, PH3 (25mm)
1	FPKA0808	1/4" (H) x 1/4" Dr. Socket Adaptor (50mm)

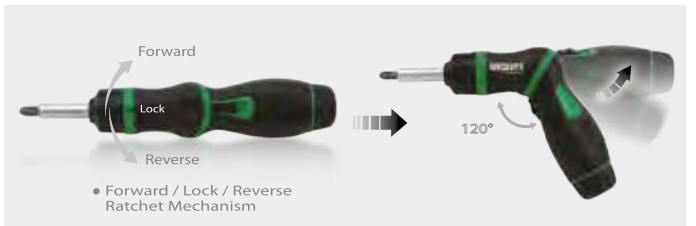

54PCS High-Torque Pistol Grip Ratchet Screwdriver, Bit & Socket Set

- Magnetic 1/4" hex shank bit holder
- 3 position, 20 tooth ratcheting action: Forward / Lock / Reverse
- High torque performance over 400 kgf-cm
- Adjustable handle (Pistol grip & Straight handle)
- Durable & comfortable bi-component plastic handle
- Set includes 38 pieces tempered & hardened S2 steel insert bits, 13 pieces CR-V steel sockets, 1 piece stainless steel magnetic bit holder, 1 piece socket adaptor and 1 piece high-torque pistol grip ratchet screwdriver handle



ITEM NO.	GAAI5401	12 (SET)
CONTENTS		
13	BAEA0804-0814	1/4" Dr. 6PT Flank Sockets 4, 4.5, 5, 5.5, 6, 7, 8, 9, 10, 11, 12, 13, 14mm (25mm)
5	FSBA0800-0803	1/4" Hex Shank Phillips Insert Bits PH0, PH1, PH2x2, PH3 (25mm)
4	FSCA0800-0803	1/4" Hex Shank Pozi Insert Bits P20, PZ1, PZ2, PZ3 (25mm)
6	FSAA0803-0808	1/4" Hex Shank Slotted Insert Bits 3, 4, 4.5, 5.5, 6.5, 8mm (25mm)
7	FSDA0802-0808	1/4" Hex Shank Hexagon Insert Bits 2, 2.5, 3, 4, 5, 6, 8mm (25mm)
7	FSEA0810-0840	1/4" Hex Shank Star Insert Bits T10, T15, T20, T25, T27, T30, T40 (25mm)
7	FSGA0810-0840	1/4" Hex Shank Star Tamperproof Insert Bits T10, T15, T20, T25, T27, T30, T40 (25mm)
2	FSHA0801 & 0802	1/4" Hex Shank Square Insert Bits SQ1 & SQ2 (25mm)
1	FSKA0808	1/4" x 1/4" Socket Adaptor (25mm)
1	FTDC0808	1/4" x 1/4" Magnetic Power Bit Holder (60mm)
1	FTEG0820	1/4" (H) High-Torque Pistol Grip Ratchet Screwdriver Handle with Storage (200mm)



Screwdrivers, Bits & Power Bits

11 Pieces 20-in-1 Interchangeable Screwdriver Set

Ergonomically designed handle provides optimum comfort in use especially for high torque tightening and loosening works.

Special blade retainer with quick-release function locks the blade firmly in the place and provides an instant change between different sizes.

Features:

- Professional SNCM+V Alloy Steel Blade
- Precision Machined Magnetic Tip
- Double-Ended Reversible Blades
- Quick-Release Blade Retainer
- Anti-Slip Featured Grip



11PCS

20-in-1 Interchangeable Screwdriver Set

- Professional SNCM+V Alloy Steel Blade
- Precision Machined Magnetic Tip
- Double-Ended Reversible Blades
- Quick-Release Blade Retainer
- Anti-Slip Featured Grip



ITEM NO.	Satin	GAAI2101
CONTENTS		
📦 12 (SET)		
1	FMAA0102	
+	1/4" Hex Shank Double End Phillips Screwdriver Bits	
	PH1xPH2 - 175mm (L)	
1	FMBA0102	
+	1/4" Hex Shank Double End Pozi Screwdriver Bits	
	PZ1xPZ2 - 175mm (L)	
2	FMCA0406 & 0507	
+	1/4" Hex Shank Double End Slotted Screwdriver Bits	
	4x6, 5x7mm - 175mm (L)	
3	FMEA0404~0606	
+	1/4" Hex Shank Hex & Ball Point Screwdriver Bits	
	4x4, 5x5, 6x6mm - 175mm (L)	
3	FMDA1015~3040	
+	1/4" Hex Shank Double End Star Screwdriver Bits	
	T10xT15, T20xT25, T30xT40 - 175mm (L)	
1	COAJ0814	
	1/4" Hex Shank Screwdriver Handle	
	1/4" x 136mm (L)	
BLOW CASE: W240 x D170 x H50 (mm)		

High-Torque Ratchet Screwdriver Handle with Storage

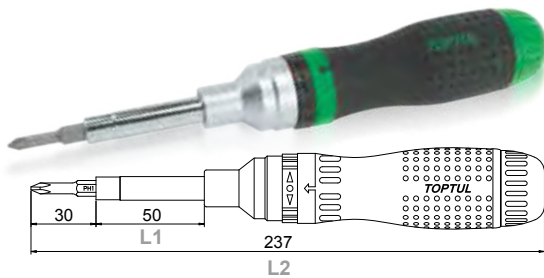

19-In-1

High Torque Ratchet Screwdriver Set



120

ITEM NO.	GAAR1002
CONTENTS	
📦 10 (SET)	
1	FTED1421
	7/16" (Hex) High-Torque Ratchet Screwdriver Handle with Storage
1	FTDA0810
	1/4" x 5/16" (Hex) Drive Shaft - 115 mm (L)
2	FKAA0105 & 0206
	1/4" Hex Shank Phillips & Slotted Screwdriver Bits
	PH1x PH2x 5mm & PH2x PH3x 6mm - 75mm (L)
1	FKAB0308
	5/16" Hex Shank Phillips & Slotted Screwdriver Bits
	PH3x PH4x 8mm - 75mm (L)
1	FKBA0102
	1/4" Hex Shank Double End Pozi Screwdriver Bits
	PZ1xPZ2 - 75mm (L)
2	FKCA1520 & 2530
	1/4" Hex Shank Double End Star Screwdriver Bits
	T15xT20 & T25xT30 - 75mm (L)
2	FKDA2E03 & 0405
	1/4" Hex Shank Double End Hexagon Screwdriver Bits
	2.5mmx3mm & 4mmx5mm - 75mm (L)

1/4" HEX

■ Color Box



■ 1/4" Hex Shank Star Tamperproof Insert Bits



TYPE	ITEM NO.	SIZE	L(mm)		
	FSGA0810	T10	25	30	360
	FSGA0815	T15	25	30	360
	FSGA0820	T20	25	30	360
	FSGA0825	T25	25	30	360
	FSGA0827	T27	25	30	360
	FSGA0830	T30	25	30	360
	FSGA0840	T40	25	30	360

■ 1/4" Hex Shank Slotted Insert Bits



TYPE	ITEM NO.	SIZE(mm)	L(mm)		
	FSAA0803	3x0.5	25	30	360
	FSAA0804	4x0.5	25	30	360
	FSAA084E	4.5x0.6	25	30	360
	FSAA085E	5.5x1	25	30	360
	FSAA086E	6.5x1.2	25	30	360
	FSAA0808	8x1.2	25	30	360

■ 1/4" Hex Shank Hexagon Insert Bits



TYPE	ITEM NO.	SIZE(mm)	L(mm)		
	FSDA0802	2	25	30	360
	FSDA082E	2.5	25	30	360
	FSDA0803	3	25	30	360
	FSDA0804	4	25	30	360
	FSDA0805	5	25	30	360
	FSDA0806	6	25	30	360
	FSDA0807	7	25	30	360
	FSDA0808	8	25	20	240
	FSDA0810	10	25	20	240
	FSDA0812	12	25	20	240

■ 1/4" Hex Shank Phillips Insert Bits



TYPE	ITEM NO.	SIZE	L(mm)		
	FSBA0800	PH0	25	30	360
	FSBA0801	PH1	25	30	360
	FSBA0802	PH2	25	30	360
	FSBA0803	PH3	25	30	360

■ 1/4" Hex Shank Square Insert Bits



TYPE	ITEM NO.	SIZE	L(mm)		
	FSHA0801	SQ1	25	30	360
	FSHA0802	SQ2	25	30	360

■ 1/4" Hex Shank Star Insert Bits



TYPE	ITEM NO.	SIZE	L(mm)		
	FSEA0806	T6	25	30	360
	FSEA0807	T7	25	30	360
	FSEA0808	T8	25	30	360
	FSEA0809	T9	25	30	360
	FSEA0810	T10	25	30	360
	FSEA0815	T15	25	30	360
	FSEA0820	T20	25	30	360
	FSEA0825	T25	25	30	360
	FSEA0827	T27	25	30	360
	FSEA0830	T30	25	30	360
	FSEA0840	T40	25	30	360
	FSEA0845	T45	25	30	360
	FSEA0850	T50	25	30	360

■ 1/4" Hex Shank Pozi Insert Bits



TYPE	ITEM NO.	SIZE	L(mm)		
	FSCA0800	PZ0	25	30	360
	FSCA0801	PZ1	25	30	360
	FSCA0802	PZ2	25	30	360
	FSCA0803	PZ3	25	30	360

Screwdrivers, Bits & Power Bits

5/16" HEX

■ Color Box



□ 5/16" Hex Shank Slotted Insert Bits



TYPE	ITEM NO.	SIZE(mm)	L(mm)		
	FSAA105E	5.5x0.8	30	20	240
	FSAA106E	6.5x1.2	30	20	240
	FSAA1008	8x1.2	30	20	240
	FSAA1010	10x1.6	30	20	240
	FSAA1012	12x1.8	30	20	240

□ 5/16" Hex Shank Hexagon Insert Bits



TYPE	ITEM NO.	SIZE(mm)	L(mm)		
	FSDA1003	3	30	30	360
	FSDA1004	4	30	30	360
	FSDA1005	5	30	30	360
	FSDA1006	6	30	30	360
	FSDA1007	7	30	30	360
	FSDA1008	8	30	30	360
	FSDA1010	10	30	20	240
	FSDA1012	12	30	20	240
	FSDA1014	14	30	20	240

□ 5/16" Hex Shank Phillips Insert Bits



TYPE	ITEM NO.	SIZE	L(mm)		
	FSBA1001	PH1	30	30	360
	FSBA1002	PH2	30	30	360
	FSBA1003	PH3	30	30	360
	FSBA1004	PH4	30	30	360

□ 5/16" Hex Shank Star Insert Bits



TYPE	ITEM NO.	SIZE	L(mm)		
	FSEA1010	T10	30	30	360
	FSEA1015	T15	30	30	360
	FSEA1020	T20	30	30	360
	FSEA1025	T25	30	30	360
	FSEA1027	T27	30	30	360
	FSEA1030	T30	30	30	360
	FSEA1040	T40	30	30	360
	FSEA1045	T45	30	30	360
	FSEA1050	T50	30	30	360
	FSEA1055	T55	30	20	240
FSEA1060	T60	30	20	240	

□ 5/16" Hex Shank Pozi Insert Bits



TYPE	ITEM NO.	SIZE	L(mm)		
	FSCA1001	PZ1	30	30	360
	FSCA1002	PZ2	30	30	360
	FSCA1003	PZ3	30	30	360
	FSCA1004	PZ4	30	30	360

10mm HEX

■ Color Box



10mm Hex Shank Hexagon Insert Bits



TYPE	ITEM NO.	SIZE(mm)	L(mm)		
	FSDA1204	4	30	30	360
	FSDA1205	5	30	30	360
	FSDA1206	6	30	30	360
	FSDA1207	7	30	30	360
	FSDA1208	8	30	30	360
	FSDA1210	10	30	20	240
	FSDA1212	12	30	20	240

10mm Hex Shank Long Hexagon Insert Bits



TYPE	ITEM NO.	SIZE(mm)	L(mm)		
	FSDB1204	4	75	15	270
	FSDB1205	5	75	15	270
	FSDB1206	6	75	15	270
	FSDB1207	7	75	15	270
	FSDB1208	8	75	15	270
	FSDB1210	10	75	15	270
	FSDB1212	12	75	15	270

10mm Hex Shank Spine Insert Bits



TYPE	ITEM NO.	SIZE	L(mm)		
	FSFA1205	M5	30	30	360
	FSFA1206	M6	30	30	360
	FSFA1208	M8	30	30	360
	FSFA1210	M10	30	20	240
	FSFA1212	M12	30	20	240

10mm Hex Shank Long Star Insert Bits



TYPE	ITEM NO.	SIZE	L(mm)		
	FSEB1220	T20	75	15	270
	FSEB1225	T25	75	15	270
	FSEB1227	T27	75	15	270
	FSEB1230	T30	75	15	270
	FSEB1240	T40	75	15	270
	FSEB1245	T45	75	15	270
	FSEB1250	T50	75	15	270
	FSEB1255	T55	75	15	270

10mm Hex Shank Star Insert Bits



TYPE	ITEM NO.	SIZE	L(mm)		
	FSEA1220	T20	30	30	360
	FSEA1225	T25	30	30	360
	FSEA1227	T27	30	30	360
	FSEA1230	T30	30	30	360
	FSEA1240	T40	30	30	360
	FSEA1245	T45	30	30	360
	FSEA1247	T47	30	30	360
	FSEA1250	T50	30	30	360
	FSEA1255	T55	30	20	240
	FSEA1260	T60	30	20	240

10mm Hex Shank Long Spine Insert Bits



TYPE	ITEM NO.	SIZE	L(mm)		
	FSFB1205	M5	75	15	270
	FSFB1206	M6	75	15	270
	FSFB1208	M8	75	15	270
	FSFB129E	M9.5	75	15	270
	FSFB1210	M10	75	15	270
	FSFB1212	M12	75	10	180

Screwdrivers, Bits & Power Bits

Quick Change Bit Holders



ITEM NO.	DRIVE(inch)	Hex Shank	L(mm)	Satin Chrome Finished	
FTAB0808	1/4	1/4"	25	30	360
FTAB1208	3/8	1/4"	29	10	120
FTAB1210	3/8	5/16"	29	10	120
FTAB1212	3/8	10mm	29	10	120
FTAB1610	1/2	5/16"	38	10	120
FTAB1612	1/2	10mm	38	10	120

8PCS

1/4" Hex Drive Bit Set

1/4"



30mm bits

ITEM NO.	CONTENTS	
GAAL0802	3 PH1, PH2, PH3 2 4x0.5, 7x1.2 mm 2 PZ1, PZ2 1 1/4" Hex Drive Offset Bit Holder Wrench	10 (SET)

7PCS

Screwdriver Bit Set

1/2"



Satin Chrome Finished

ITEM NO.	CONTENTS	
GAAT0709	3 FSBA1001~1003 3 5/16" x PH1, PH2, PH3 3 FSAA105E~1008 3 5/16" x 5.5x0.8, 6.5x1.2, 8x1.2 mm 1 FTAB1610 1 1/2" x 5/16" Bits Holder	50 (SET)

8PCS

1/4" Hex Drive Star Tamperproof Bit Set

1/4"



30mm bits

ITEM NO.	CONTENTS	
GAAL0801	7 T10, T15, T20, T25, T27, T30, T40 1 1/4" Hex Drive Offset Bit Holder Wrench	10 (SET)

7PCS

Screwdriver Bit Set

1/2"



Satin Chrome Finished

ITEM NO.	CONTENTS	
GAAT0705	6 FSEA1225~1255 6 10mm x T25, T30, T40, T45, T50, T55 1 FTAB1612 1 1/2" x 10 mm Bits Holder	50 (SET)

8PCS

1/4" Hex Drive Hexagon Bit Set

1/4"



30mm bits

ITEM NO.	CONTENTS	
GAAL0803	7 2, 3, 4, 5, 6, 7, 8 mm 1 1/4" Hex Drive Offset Bit Holder Wrench	10 (SET)

7PCS

Screwdriver Bit Set

1/2"



Satin Chrome Finished

ITEM NO.	CONTENTS	
GAAT0707	6 FSDA1204~1212 6 10mm x 4, 5, 6, 8, 10, 12 mm 1 FTAB1612 1 1/2" x 10 mm Bits Holder	50 (SET)



Blister



TOPTUL
Power Screwdriver Bits

1/4" Hex Shank Magnetic Power Nut Setter

- Made of Chrome Vanadium Steel
- Precision machined tip for proper fit
- Magnetic shaft holds fastener securely
- Rugged single-piece construction provides long service life under constant use
- Ideal for quick and easy driving of nuts, bolts and hex head screws



TYPE	ITEM NO.	SIZE(mm)	L(mm)		
○	BEAA0806	6	65	50	400
	BEAA0807	7	65	50	400
	BEAA0808	8	65	50	400
	BEAA0810	10	65	50	400
	BEAA0813	13	65	50	400

1/4" Hex Shank Magnetic Power Nut Setter

- Made of S2 Alloy Steel
- Precision machined tip for proper fit
- Magnetic shaft holds fastener securely
- Rugged single-piece construction provides long service life under constant use
- Ideal for quick and easy driving of nuts, bolts and hex head screws



TYPE	ITEM NO.	SIZE(mm)	L(mm)		
○	BEAD0808	8	200	10	120

1/4" Hex Shank Socket Adaptor

Made of Chrome Vanadium Alloy Steel
1/4" square drive with ball retainer



ITEM NO.	SIZE	L(mm)		
FSKA0808	■ 1/4" x ○ 1/4"	25	30	360

1/4" Hex Shank Socket Adaptor

Made of Chrome Vanadium Alloy Steel
1/4" square drive with ball retainer
1/4" hex fitting for power tools or hand drivers



ITEM NO.	SIZE	L(mm)		
FPKA0808	■ 1/4" x ○ 1/4"	50	20	240

Magnetic Power Bit Holder

Magnetic 1/4" (H) stainless steel bit driver holder



ITEM NO.	SIZE	L(mm)		
FTDC0808	● 1/4" x ○ 1/4"	60	15	270

Screwdrivers, Bits & Power Bits

40PCS

3/8" & 1/2" DR. Bit Set

3/8"

1/2"



ITEM NO.	CONTENTS	4 (SET)
GAAD4002	5 FSFA1205-1212	
	○ 10mm Hex Shank Spline Insert Bits	
	M5, M6, M8, M10, M12	
	5 FSFB1205-1212	
	○ 10mm Long Hex Shank Spline Insert Bits	
	M5, M6, M8, M10, M12	
	7 FSDA1204-1212	
	○ 10mm Hex Shank Hexagon Insert Bits	
	4, 5, 6, 7, 8, 10, 12 mm	
	7 FSDB1204-1212	
	○ 10mm Long Hex Shank Hexagon Insert Bits	
	4, 5, 6, 7, 8, 10, 12 mm	
	7 FSEA1220-1255	
○ 10mm Hex Shank Star Insert Bits		
T20, T25, T30, T40, T45, T50, T55		
7 FSEB1220-1255		
○ 10mm Long Hex Shank Star Insert Bits		
T20, T25, T30, T40, T45, T50, T55		
1 FTAB1212		
3/8" Dr.x10mm(H) Quick Change Bit Holder		
1 FTAB1612		
1/2" Dr.x10mm(H) Quick Change Bit Holder		

METAL CASE: W370 x D154 x H50 (mm)

31PCS

Screwdriver Bit Set



ITEM NO.	CONTENTS	10 (SET)
GAAW3101	6 PH0, PH1x2pcs, PH2x2pcs, PH3	
	6 PZ0, PZ1x2pcs, PZ2x2pcs, PZ3	
	3 4x0.5, 5.5x1, 6.5x1.2 mm	
	4 ○ 3, 4, 5, 6 mm	
	11 ○ T6, T7, T8, T9, T10, T15, T20, T25, T27, T30, T40	
	1 ● 1/4" x ○ 1/4" Magnetic Power Bit Holder	

PLASTIC BOX: W106 x D68 x H41 (mm)

31PCS

1/4" Hex Drive Mini Ratchet Bit Set



ITEM NO.	GABW3103	30 (SET)
CONTENTS		
3 FSAA0804-086E		
● 1/4" Hex Shank Slotted Insert Bits		
4, 5.5, 6.5 mm		
3 FSBA0801-0803		
○ 1/4" Hex Shank Phillips Insert Bits		
PH1, PH2, PH3		
3 FSCA0801-0803		
○ 1/4" Hex Shank Pozzi Insert Bits		
PZ1, PZ2, PZ3		
4 FSDA0803-0806		
○ 1/4" Hex Shank Hexagon Insert Bits		
3, 4, 5, 6 mm		
7 FSEA0810-0840		
○ 1/4" Hex Shank Star Insert Bits		
T10, T15, T20, T25, T27, T30, T40		
7 FSGA0810-0840		
○ 1/4" Hex Shank Star Tamperproof Insert Bits		
T10, T15, T20, T25, T27, T30, T40		
2 FSHA0801 & 0802		
○ 1/4" Hex Shank Square Insert Bits		
SQ1 & SQ2		
1 FSKA0808		
1/4" (H) x 1/4" Dr. Socket Adaptor		
1 CHDV0809		
1/4" (H) 60 Teeth Mini Reversible Bit Ratchet Handle		

PLASTIC BOX: W115 x D85 x H37 (mm)

12PCS

1/4" (H) Mini Reversible Bit Ratchet & Bit Set



ITEM NO.	GAAR1201	10 (SET)
CONTENTS		
1 CHDV0809		
1/4" (H) Mini Reversible Bit Ratchet Handle (90mm)		
3 FSAA084E-086E		
● 1/4" Hex Shank Slotted Insert Bits		
4, 5, 5.5, 6.5 (25mm)		
3 FSBA0801-0802		
○ 1/4" Hex Shank Phillips Insert Bits		
PH1, PH2x2 (25mm)		
3 FSEA0815-0825		
○ 1/4" Hex Shank Star Insert Bits		
T15, T20, T25 (25mm)		
2 FSHA0801 & 0802		
○ 1/4" Hex Shank Square Insert Bits		
SQ1 & SQ2 (25mm)		



Pliers Series Exceptional

multi-purposes cutting and gripping tools with various capacity to use.

PLIERS SERIES



Pliers

▣ Cable Cutter

- Chrome Vanadium Steel Material
- Induction hardened cutting edge
- Shear action for a clean, precise cut
- Comfortable double plastic-coated grip handle



ITEM NO.	MAX. CUTTING CAPACITY (mm ²)	L (inch)		
DNAA1210	60	10	6	48

▣ Groove-Joint Water Pump Pliers

- Chrome Vanadium Steel Material
- 7-position groove joint adjustable head
- Strong self-gripping teeth for joints, fasteners and pipes
- Comfort non-slip grip handle



ITEM NO.	SIZE (inch)		
DDAA1212	12	10	40
DDAA1216	16	10	40

▣ Cable Cutter

- Chrome Vanadium Steel Material
- Induction hardened cutting edge
- Shear action for a clean, precise cut
- Comfortable double plastic-coated grip handle
- Cut copper and aluminum cable
- Notched end for stripping wires



ITEM NO.	MAX. CUTTING CAPACITY (mm ²)	L (inch)		
DNAA1206	22	6	6	120
DNAA1208	38	8	6	72

▣ Groove-Joint Water Pump Pliers

- Chrome Vanadium Steel Material
- 7-position groove joint adjustable head
- Strong self-gripping teeth for joints, fasteners and pipes
- Comfort non-slip grip handle



ITEM NO.	SIZE (inch)		
DDAA1210	10	10	40

▣ Long Reach Nose Pliers

(CR-MO)



ITEM NO.	BENDING (Degree)	SIZE (inch)		
DFAI1211	90°	11	10	40
DFAH1211	45°	11	10	40
DFAG1211	0°	11	10	40

▣ Long Hose Gripper Pliers

(CR-MO)



ITEM NO.	HEAD (inch)	SIZE (inch)		
DFAD1211	5/16	11	10	40
DFAE1211	1/2	11	10	40
DFAF1211	3/4	11	10	40

Box-Joint Water Pump Pliers with Quick-Adjust Button



- NEW

ITEM NO.	SIZE (inch)		
DDAG1310	10	10	40



Retaining Ring Pliers

90° Retaining Ring Pliers

(External Ring)

- Chrome Vanadium Steel Material
- Spring-assisted opening for outside circlip
- Anti-slip, turned tips
- Comfort non-slip grip handle



ITEM NO.	SIZE(inch)		
DCAA1207	7	10	40
DCAA1209	9	10	40
DCAA1212	12	4	24

Straight Retaining Ring Pliers

(External Ring)

- Chrome Vanadium Steel Material
- Spring-assisted opening for outside circlip
- Anti-slip, turned tips
- Comfort non-slip grip handle



ITEM NO.	SIZE(inch)		
DCAB1207	7	10	40
DCAB1209	9	10	40
DCAB1212	12	6	36

90° Retaining Ring Pliers

(Internal Ring)

- Chrome Vanadium Steel Material
- Spring-assisted opening for inside circlip
- Anti-slip, turned precision tips
- Comfort non-slip grip handle



ITEM NO.	SIZE(inch)		
DCAC1207	7	10	40
DCAC1209	9	10	40

90° Retaining Ring Pliers

(Internal Ring)

- Chrome Vanadium Steel Material
- For inside circlips
- Anti-slip, turned tips
- Comfort non-slip grip handle



ITEM NO.	SIZE(inch)		
DCAC1212	12	4	24

4PCS

Retaining Ring Pliers Set



ITEM NO.	CONTENTS	
GPAQ0401	<ul style="list-style-type: none"> 1 DCAB1207 Straight Retaining Ring Pliers (External Ring) - 7" 1 DCAD1207 Straight Retaining Ring Pliers (Internal Ring) - 7" 1 DCAA1207 90° Retaining Ring Pliers (External Ring) - 7" 1 DCAC1207 90° Retaining Ring Pliers (Internal Ring) - 7" 	20 (SET)

Straight Retaining Ring Pliers

(Internal Ring)

- Chrome Vanadium Steel Material
- Spring-assisted opening for inside circlip
- Anti-slip, turned precision tips
- Comfort non-slip grip handle



ITEM NO.	SIZE(inch)		
DCAD1207	7	10	40
DCAD1209	9	10	40

Straight Retaining Ring Pliers

(Internal Ring)

- Chrome Vanadium Steel Material
- For inside circlips
- Anti-slip, turned tips
- Comfort non-slip grip handle



ITEM NO.	SIZE(inch)		
DCAD1212	12	6	36

Pliers

Professional Series

Pro-Series

Double Hi-Leverage Combination Pliers

- Premium tool steel pliers head for superior strength and durability
- Induction hardened & precision machined cutting edges
- Heat treated robust CR-MO joint rivet for smooth and consistent operation
- Double high-leverage design increases cutting power by 60%
- Spring-loaded return for quick repetitive opening
- 1/3 lighter than standard pliers reduces hand fatigue
- Safety lock keeps pliers securely closed when not in use
- Ergonomically designed TPE+TPR plastic grip handle for much improved comfort and added control



ITEM NO.	SIZE(inch)		
DBBE2208	8	10	40

Pro-Series

Double Hi-Leverage Diagonal Cutting Pliers

- Premium tool steel pliers head for superior strength and durability
- Induction hardened & precision machined cutting edges
- Heat treated robust CR-MO joint rivet for smooth and consistent operation
- Double high-leverage design increases cutting power by 60%
- Spring-loaded return for quick repetitive opening
- 1/3 lighter than standard pliers reduces hand fatigue
- Safety lock keeps pliers securely closed when not in use
- Ergonomically designed TPE+TPR plastic grip handle for much improved comfort and added control



ITEM NO.	SIZE(inch)		
DEBF2207	7	10	40

Pro-Series

Double Hi-Leverage Long Nose Pliers

- Premium tool steel pliers head for superior strength and durability
- Induction hardened & precision machined cutting edges
- Serrated and rigid jaws, ideal for forming, bending works
- Heat treated robust CR-MO joint rivet for smooth and consistent operation
- Double high-leverage design increases cutting power by 60%
- Spring-loaded return for quick repetitive opening
- 1/3 lighter than standard pliers reduces hand fatigue
- Safety lock keeps pliers securely closed when not in use
- Ergonomically designed TPE+TPR plastic grip handle for much improved comfort and added control



ITEM NO.	SIZE(inch)		
DFBE228E	8-1/2	10	40

Long Nose Pliers

- Chrome Molybdenum Steel Material
- High-frequency hardened cutting edges for optimum power and durability
- Serrated and rigid jaws, ideal for forming, bending and precision assembly works
- Ergonomic comfort-grip handle



ITEM NO.	SIZE(inch)		
DFBB2206	6	10	40
DFBB2208	8	10	40

Flat Nose Pliers

- Chrome Molybdenum Steel Material
- High precision milling smooth jaws for extra grip and ease of handling
- Serrated and accurately machined flat jaws provide a firm grip on the objects
- Ergonomic comfort-grip handle



ITEM NO.	SIZE(inch)		
DFBC2206	6	10	40

Combination Pliers

- Chrome Molybdenum Steel Material
- Precision-hardened pliers head for on-the-job toughness
- High-frequency hardened cutting edges for optimum power and durability
- Ergonomic comfort-grip handle



ITEM NO.	SIZE(inch)		
DBBB2206	6	10	40
DBBB2207	7	10	40
DBBB2208	8	10	40

Heavy Duty Diagonal Cutting Pliers

- Chrome Molybdenum Steel Material
- High-leverage design, rivet is closer to the cutting edge for optimum cutting and gripping power
- Induction hardened cutting knives for long service life
- Ergonomic comfort-grip handle



ITEM NO.	SIZE(inch)		
DEBC2207	7	10	40
DEBC2208	8	10	40

Bent Nose Pliers

- Chrome Molybdenum Steel Material
- Bent nose with 45 slang for easy operation in complicated working space
- Serrated and rigid jaws, ideal for forming, bending and precision assembly works
- Ergonomic comfort-grip handle



ITEM NO.	SIZE(inch)		
DFBA2206	6	10	40
DFBA2208	8	10	40

Diagonal Cutting Pliers

- Chrome Molybdenum Steel Material
- Short jaws and beveled cutting edges permit close cutting of wire
- Hot-riveted joints ensures smooth action and no handle wobble
- Ergonomic comfort-grip handle



ITEM NO.	SIZE(inch)		
DEBB2206	6	10	40

Combination Slip-Joint Pliers (with wire cutter)

- Made of robust Chrome Molybdenum Alloy Steel
- Slim head design for easy access
- Diamond serrated jaws for more gripping power
- High-Frequency hardened cutting edge for long working life
- Precision machined jaws for maximum gripping and turning
- Cutting Capacity: Up to Ø1.6mm medium hard wire
- Ergonomic designed, non-slip TPE+TPR plastic grip handles



ITEM NO.	SIZE(inch)		
DHBB2208	8	10	40

Heavy Duty End Cutting Nippers

- Chrome Molybdenum Steel Material
- High-leverage design provides exceptional cutting of hard and soft wire, bolts, nails, rivets and pins
- Induction hardened precision cutting edges ensures for long service life
- Ergonomic comfort-grip handle



ITEM NO.	SIZE(inch)		
DJBA2206	6	10	40
DJBA2208	8	10	40

Wire Stripping Pliers

- Chrome Molybdenum Steel Material
- Induction hardened long life stripping edges
- Easy lockable adjusting screw for setting the desired diameter up to Ø4.5mm
- Ergonomic comfort-grip handle



ITEM NO.	SIZE(inch)		
DIBA2206	6	10	40

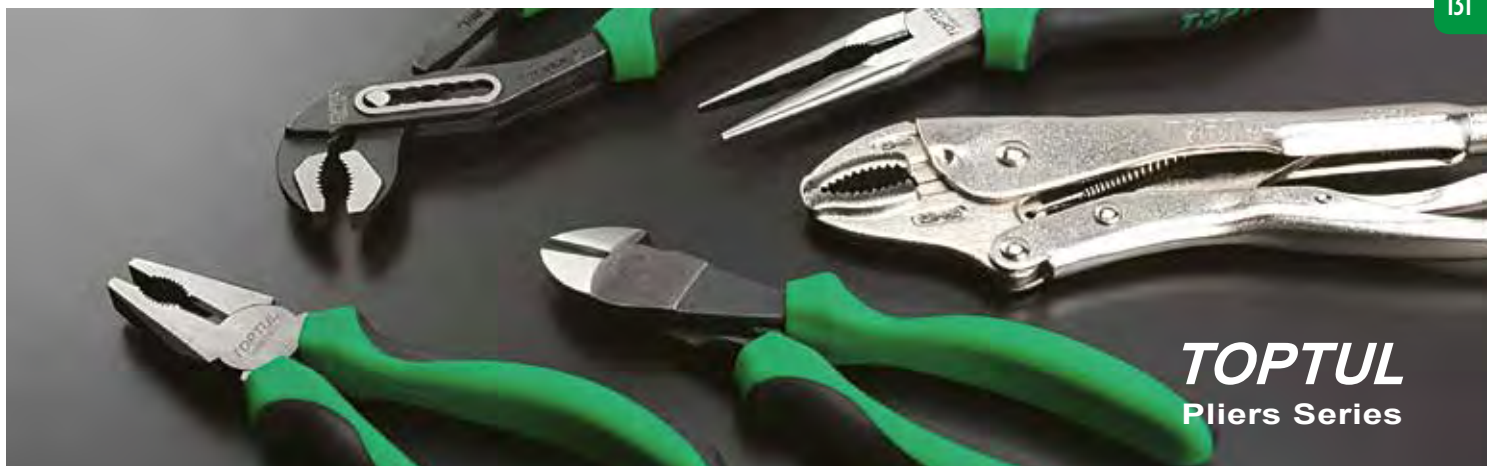

TOPTUL
Pliers Series

Pliers

Box-Joint Water Pump Pliers

- Chrome Molybdenum Steel Material
- Optimum lever action with 7-position adjustment
- Heavy duty box-joint design, self-gripping teeth for joints, nuts and pipes
- Ergonomic comfort-grip handle



ITEM NO.	SIZE(inch)		
DDBA2210	10	10	40

3PCS Pliers Set



ITEM NO.	CONTENTS	
GAAE0304	1 DBBB2207 Combination Pliers - 7" 1 DEBC2207 Heavy Duty Diagonal Cutting Pliers - 7" 1 DFBB2208 Long Nose Pliers - 8"	8 (SET)

Plier Sets

3PCS Pliers Set



ITEM NO.	CONTENTS	
GAAE0302	1 DEBB2206 Diagonal Cutting Pliers - 6" 1 DBBB2207 Combination Pliers - 7" 1 DFBB2208 Long Nose Pliers - 8"	8 (SET)

3PCS Pliers Set



ITEM NO.	CONTENTS	
GAAE0307	1 DBBB2208 Combination Pliers - 8" 1 DEBC2208 Heavy Duty Diagonal Cutting Pliers - 8" 1 DFBB2208 Long Nose Pliers - 8"	8 (SET)

3PCS Pliers Set



ITEM NO.	CONTENTS	
GAAE0303	1 DBBB2207 Combination Pliers - 7" 1 DFBB2208 Long Nose Pliers - 8" 1 DDBA2210 Box-Joint Water Pump Pliers - 10"	8 (SET)

4PCS Pliers Set



ITEM NO.	CONTENTS	
GAAE0402	1 DBBB2207 Combination Pliers - 7" 1 DEBC2207 Heavy Duty Diagonal Cutting Pliers - 7" 1 DFBB2208 Long Nose Pliers - 8" 1 DDBA2210 Box-Joint Water Pump Pliers - 10"	8 (SET)

Electronics Pliers

Electronics

Combination Pliers

High precision-machined jaws
Spring-assisted opening design
Ergonomic comfort-grip handle



ITEM NO.	SIZE(inch)		
DBBC2205	5	10	40

Electronics

End Cutter Pliers

High precision-machined jaws
Spring-assisted opening design
Ergonomic comfort-grip handle



ITEM NO.	SIZE(inch)		
DJBB2204	4	10	40

Electronics

Long Nose Pliers

High precision-machined jaws
Spring-assisted opening design
Ergonomic comfort-grip handle



ITEM NO.	SIZE(inch)		
DFBJ2205	5	10	40

Electronics

Bent Nose Pliers

High precision-machined jaws
Spring-assisted opening design
Ergonomic comfort-grip handle



ITEM NO.	SIZE(inch)		
DFBK2205	5	10	40

Electronics

Diagonal Cutting Pliers

High precision-machined jaws
Spring-assisted opening design
Ergonomic comfort-grip handle



ITEM NO.	SIZE(inch)		
DEBD2204	4	10	40

Mini Side Cutter Pliers

Made of heat treated, hardened 3mm thick Stainless Steel
Precision machined jaws for maximum cutting power
Superior access in tight-fit applications
Smooth spring return action jaws for quick cut and reduce the operational fatigue
Environmentally friendly, non-slip PVC comfort grip handles



ITEM NO.	SIZE(inch)		
DEBE204E	4.5	6	120



TOPTUL

High precision-machined
Electronics Pliers

Pliers

VDE Insulated

TOPTUL Certified Insulated Pliers Series
Produced in accordance with DIN EN/IEC 60900
Up to 1000V AC & 1500V DC Electrical Safety



1000V
IEC 60900



VDE Insulated

Diagonal Cutting Pliers

- Chrome Molybdenum Steel Material
- Handles insulation meets VDE and international standard DIN EN/IEC 60900
- Short jaws and beveled cutting edges permit close cutting of wire
- Hot-riveted joints ensures smooth action and no handle wobble
- Ergonomic comfort-grip handle



ITEM NO.	SIZE(inch)		
DGBC2106	6	10	40

VDE Insulated

Long Nose Pliers

- Chrome Molybdenum Steel Material
- Handles insulation meets VDE and international standard DIN EN/IEC 60900
- High-frequency hardened cutting edges for optimum power and durability
- Serrated and rigid jaws, ideal for forming, bending and precision assembly works
- Ergonomic comfort-grip handle



ITEM NO.	SIZE(inch)		
DGBB2106	6	10	40
DGBB2108	8	10	40

3PCS

VDE Insulated Pliers Set



ITEM NO.	CONTENTS	
GAAE0301	<ul style="list-style-type: none"> 1 DGBA2107 VDE Insulated Combination Pliers - 7" 1 DGBB2108 VDE Insulated Long Nose Pliers - 8" 1 DGBC2106 VDE Insulated Diagonal Cutting Pliers - 6" 	8 (SET)

VDE Insulated

Box-Joint Water Pump Pliers

- Chrome Molybdenum Steel Material
- Handles insulation meets VDE and international standard DIN EN/IEC 60900
- Optimum lever action with 7-position adjustment
- Heavy duty box-joint design, self-gripping teeth for joints, nuts and pipes
- Ergonomic comfort-grip handle



ITEM NO.	SIZE(inch)		
DGBE2110	10	10	40

VDE Insulated

Combination Pliers

- Chrome Molybdenum Steel Material
- Handles insulation meets VDE and international standard DIN EN/IEC 60900
- Precision-hardened pliers head for on-the-job toughness
- High-frequency hardened cutting edges for optimum power and durability
- Ergonomic comfort-grip handle



ITEM NO.	SIZE(inch)		
DGBA2106	6	10	40
DGBA2107	7	10	40
DGBA2108	8	10	40

Long Nose Locking Pliers with Wire Cutters

- Mighty CR-V jaw with cutter in design
- Robust Chrome Molybdenum Alloy Steel handle
- Professional heat treated and machined
- Nickel plated finish



TOPTUL Locking Pliers Series

ITEM NO.	SIZE(inch)		
DAAS1A06	6	10	80
DAAS1A09	9	10	40

Locking Chain Clamp

- Robust Chrome Molybdenum Alloy Steel handle
- Professional heat treated and machined
- Adjustable locking pliers design chain clamp
- Nickel plated finish



ITEM NO.	CHAIN LENGTH (inch)	HANDLE (inch)		
DMAB1A18	18	9	6	24

Sheet Metal Locking Pliers

- High quality Chrome Molybdenum Alloy Steel
- Professional heat treated and machined
- Suitable for all kinds of bending and crimp edges
- Nickel plated finish



ITEM NO.	SIZE(inch)		
DAAV1A08	8	1	30

C-Clamp Locking Pliers with Standard Tip

- High quality, mighty CR-V jaw
- Robust Chrome Molybdenum Alloy Steel handle
- Professional heat treated and machined
- Ideal for clamping angle iron and awkward pieces
- Nickel plated finish



ITEM NO.	SIZE(inch)		
DAAU1A11	11	10	20

Welding Clamps

- High quality Chrome Molybdenum Alloy Steel
- Professional heat treated and machined
- Nickel plated finish



ITEM NO.	SIZE(inch)		
DAAT1A09	9	1	24

Pliers

Curved Jaw Locking Pliers (X-Jaw Type)

- Mighty CR-V jaw
- Robust Chrome Molybdenum Steel handle
- Special X-Jaw design and mechanism grips tighter as more torque is applied to the pliers
- Self-engaging lower jaws provides much more gripping power than traditional locking pliers
- Provided maximum torque without requiring heavy input pressure
- Professional heat treated and machined
- With adjusting screw and quick release lever
- Nickel plated finish



ITEM NO.	SIZE(inch)		
DAA1A10	10	6	36



Combination jaw design for gripping flat, round, square and shaped objects



New X-Jaw, diamond shaped large jaws with cross angled teeth provides much more gripping power with no slipping or stripping

Straight Jaw Locking Pliers

- High quality, mighty CR-V jaw
- Robust Chrome Molybdenum Alloy Steel handle
- Professional heat treated and machined
- With adjusting screw and quick release lever
- Nickel plated finish



ITEM NO.	SIZE(inch)		
DAAR1A07	7	10	40

Curved Jaw Locking Pliers with Wire Cutters

- Mighty CR-V jaw with cutter in design
- Robust Chrome Molybdenum Alloy Steel handle
- Professional heat treated and machined
- Nickel plated finish



ITEM NO.	SIZE(inch)		
DAAQ1A05	5	10	80
DAAQ1A07	7	10	40

Curved Jaw Locking Pliers with Wire Cutters

- Mighty CR-MO jaw with cutter in design
- Robust Chrome Molybdenum Alloy Steel handle
- Professional heat treated and machined
- Nickel plated finish



ITEM NO.	SIZE(inch)		
DAAQ1A10	10	10	40

Straight Jaw Locking Pliers

- High quality Chrome Molybdenum Alloy Steel
- Professional heat treated and machined
- With adjusting screw and quick release lever
- Nickel plated finish



ITEM NO.	SIZE(inch)		
DAAR1A10	10	10	40

Curved Jaw Locking Pliers with Wire Cutter

- Mighty CR-V jaw with cutter in design
- Robust Chrome Molybdenum Alloy Steel handle
- Professional heat treated and machined
- With adjusting screw and quick release lever
- Nickel plated finish



ITEM NO.	SIZE(inch)		
DAAQ2B07	7	10	40
DAAQ2B10	10	10	40



Hammers & Striking Tools Series Different

types of hammers, chisels and punches for various workshop applications.

HAMMERS & STRIKING TOOLS SERIES



Hammers & Striking Tools

Engineers Hammer



ITEM NO.	HEAD WGT (g)	HEAD Ø(mm)	L (mm)		
HAAA0330	300	23	300	6	48
HAAA0532	500	27	320	6	36
HAAA0835	800	33	350	6	24
HAAA1036	1000	36	360	4	16
HAAA1538	1500	42	380	4	12
HAAA2040	2000	47	400	4	12

Dead Blow Hammer

Steel-ball dead blow design
Dead blow eliminates rebound, delivers more power
Suitable for careful driving of bearings, cases, sleeves, sealing rings and etc



ITEM NO.	HEAD WGT (lb/oz)	HEAD Ø(mm)	L (mm)		
HAAB1038	1 (16)	38	290	5	30
HAAB1546	1.5 (24)	46	310	6	24
HAAB2050	2 (32)	50	340	6	24

Soft Face Hammer

Comes with two interchangeable and replaceable soft faces hammer heads, PU (yellow) and Nylon (white) durable plastic material
Genuine hickory wooden handle



PU/ Nylon Material

ITEM NO.	HEAD Ø(mm)	L(mm)		
HAAF3530	35	303	6	48

Claw Hammer



ITEM NO.	HEAD WGT (oz)	HEAD Ø(mm)	L (mm)		
HAAD1633	16	28	330	6	36

Club Hammer

Fully hardened tempered steel head for long life
Genuine hickory wooden handled club hammers with polished surfaces



ITEM NO.	HEAD WGT (lb)	HEAD Ø(mm)	L (mm)		
HAAE2527	2.5	37	270	6	18

Ball Peen Hammer

Drop forged, heat treat steel head
Highly useful in metal fabrication and metal working



ITEM NO.	HEAD WGT (oz)	HEAD Ø(mm)	L (mm)		
HAAC0830	8	23.5	300	12	48
HAAC1635	16	30.5	350	6	36
HAAC2440	24	35.5	396	4	24
HAAC3240	32	38.5	400	4	24
HAAC4042	40	43.0	416	4	12

5PCS

Chisel Punch Set



ITEM NO.	CONTENTS	10 (SET)
GAAV0501	<ul style="list-style-type: none"> 5 Pin Punch : 4x9.5x150 mm Cape Chisel : 5x9.5x130 mm Cold Chisel : 12x9.5x130 mm Taper Punch : 3x9.5x120 mm Center Punch : #2x9.5x120 mm 	

6PCS

Pin Punch Set



- Chrome Molybdenum Steel Material
- Professional heat treatment for optimum toughness and durability
- Roll pin tips are ideal tools for removing hollow, split roll pins
- Chrome plated finish for maximum corrosion protection

ITEM NO.	CONTENTS	10 (SET)
GAAV0601	<ul style="list-style-type: none"> 6 Pin Punch : 2x8.0x115, 3x8.0x125, 4x9.5x150, 5x9.5x165, 6x12.7x180, 8x12.7x180 mm 	

2PCS

Ribbed Flat Chisels & Handle Set



ITEM NO.	CONTENTS	10 (SET)
GAAE0201	<ul style="list-style-type: none"> 1 HCAA2925 Ribbed Flat Chisels - 29x250 mm 1 COAK1612 Ribbed Flat Chisels Handle - 78x118x16 mm 	

2PCS

Ribbed Flat Chisels & Handle Set



ITEM NO.	CONTENTS	10 (SET)
GAAE0202	<ul style="list-style-type: none"> 1 HCAA3430 Ribbed Flat Chisels - 34x300 mm 1 COAK1812 Ribbed Flat Chisels Handle - 78x118x17.5 mm 	

Ribbed Flat Chisels Handle



ITEM NO.	SIZE (W)x(L)mm	5	80
COAK1612	78 x 118 (For HCAA2925 - 250 L)		
COAK1812	78 x 118 (For HCAA3430 - 300 L)		

Ribbed Flat Chisels

CR-MO



Chrome Molybdenum Steel Material

ITEM NO.	SIZE (W)x(L)mm	15	240
HCAA1813	18 x 125		
HCAA2115	21 x 150		
HCAA2620	26 x 200		
HCAA2925	29 x 250		
HCAA3430	34 x 300		

5PCS

Ribbed Flat Chisel Set



ITEM NO.	CONTENTS	6 (SET)
GPAQ0504	<ul style="list-style-type: none"> 5 HCAA1813-3430 Ribbed Flat Chisels 18x125, 21x150, 26x200, 29x250, 34x300 mm 	

Hammers & Striking Tools

Pin Punch

(SNCM+V)



ITEM NO.	SIZE(mm)	L(mm)	OCTAGONAL SHANK(mm)		
HBAA0212	2	120	8	15	240
HBAA0313	3	130	8	15	240
HBAA0415	4	150	9.5	15	240
HBAA0516	5	160	9.5	15	180
HBAA0618	6	180	12.5	10	120
HBAA0820	8	200	12.5	10	120

Center Punch

(SNCM+V)



ITEM NO.	SIZE(mm)	L(mm)	OCTAGONAL SHANK(mm)		
HBAC0310	3	100	8	15	240
HBAC0412	4	120	9.5	15	240
HBAC0513	5	130	9.5	15	240
HBAC0614	6	140	12.5	10	120
HBAC0816	8	160	16	10	120

Taper Punch

(SNCM+V)



ITEM NO.	SIZE(mm)	L(mm)	OCTAGONAL SHANK(mm)		
HBAB0211	2	110	9.5	20	320
HBAB0312	3	120	9.5	20	320
HBAB0414	4	140	9.5	15	240
HBAB0515	5	150	9.5	15	360
HBAB0616	6	160	9.5	15	360

Flat Chisel

(SNCM+V)



ITEM NO.	SIZE(mm)	L(mm)	OCTAGONAL SHANK(mm)		
HCAB1014	10	140	8	10	160
HCAB1215	12	150	9.5	10	160
HCAB1516	15	160	12.5	10	120
HCAB1918	19	180	16	5	60
HCAB2220	22	200	16	5	40
HCAB2522	25	220	19	5	40

10PCS Punch Set



ITEM NO.	CONTENTS	
GPAQ1001	4 HBAA0313-0618 Pin Punch 3x130, 4x150, 5x160, 6x180 mm 2 HBAB0312-0616 Taper Punch 3x120, 6x160 mm 4 HBAC0310-0614 Center Punch 3x100, 4x120, 5x130, 6x140 mm	20 (SET)

5PCS Flat Chisel Set



ITEM NO.	CONTENTS	
GPAQ0505	5 HCAB1014-2220 Flat Chisel 10x140, 12x150, 15x160, 19x180, 22x200 mm	20 (SET)

NEW STRIKING TOOLS
WITH COMFORTABLE
ANTI-ROLL SHEATH



Soft Grip Pin Punch

CR-MO



ITEM NO.	SIZE(mm)	L(mm)	OCTAGONAL SHANK(mm)		
HBBA0214	2	140	8	5	80
HBBA0315	3	150	8	5	80
HBBA0418	4	180	10	5	80
HBBA0520	5	200	10	5	40
HBBA0621	6	210	12	5	40
HBBA0822	8	220	12	5	40



Soft Grip Flat Chisel

CR-MO



ITEM NO.	SIZE(mm)	L(mm)	OCTAGONAL SHANK(mm)		
HCBB1015	10	150	8	5	80
HCBB1518	15	180	10	5	80
HCBB1920	19	200	12	5	40
HCBB2522	25	220	15.8	3	24

Soft Grip Cape Chisel

CR-MO



ITEM NO.	SIZE(mm)	L(mm)	OCTAGONAL SHANK(mm)		
HCBC0517	5	170	10	5	80
HCBC0718	7	180	12	5	40

Soft Grip Center Punch

CR-MO



ITEM NO.	SIZE(mm)	L(mm)	OCTAGONAL SHANK(mm)		
HBBC0419	4	185	10	5	80
HBBC0619	6	185	10	5	80

Soft Grip Taper Punch

CR-MO



ITEM NO.	SIZE(mm)	L(mm)	OCTAGONAL SHANK(mm)		
HBBB0219	2	185	10	5	80
HBBB0319	3	185	10	5	80
HBBB0419	4	185	10	5	80
HBBB0519	5	185	10	5	80
HBBB0619	6	185	10	5	80
HBBB0819	8	185	12	5	80

TOPTUL®

THE MARK OF PROFESSIONAL TOOLS

the choice of professionals



Tool Storage & Display Series Choices

of tool storage system build up individual favorite working stations.

TOOL STORAGE & DISPLAY SERIES

A photograph of a white TOPTUL truck parked in front of a building. The truck has the TOPTUL logo and 'THE MARK OF PROFESSIONAL TOOLS' written on its side. The building has a large window and a door.

TOPTUL®
THE MARK OF PROFESSIONAL TOOLS

142

PROFESSIONAL HAND TOOLS



Drawer

NEW MODEL

Mobile Tool Trolley

PRO-PLUS SERIES GREEN

ITEM NO.	SIZE(W)x(D)x(H)mm
TCAG0702	Overall: 746x462x805 Overall w/caster: 746x462x978 5 Drawer: 578x378x75 2 Drawer: 578x378x155

PRO-PLUS SERIES BLUE

Trolley Part No.
TCAG0704



■ PRO-PLUS SERIES TOOL TROLLEY

- 5 Medium & 2 Large Drawers with Central Locking System
- Smooth Ball Bearing Slide Drawers with Auto-Return Function
- 100% Fully Opening and Retractable Drawers
- Safety Internal Drawer Locking System (Prevent Drawers from Opening When in Motion)
- Loading Capacity Per Drawer 45 kg
- Rounded Edge & Recessed-Frame Sidewall Body Construction
- New Style Composite Drawer Handle
- Large Arc-Shaped Side Handle
- Smart Foldable Key
- 10mm EVA Material Top Mat
- Heavy Duty 5"x2" Anti-Slip & Shockproof TPR Casters with Lock (2 Fixed Casters and 2 Swivel Casters with Lock)
- Electro-Power Coating to Resist Scratches and Solvent Markings
- Supplied with Drawer Liners and One Spray Can Holder

Professional

Rounded Edge & Recessed-Frame Sidewall Body Construction



Smooth Ball Bearing Slides W/Safety Internal Drawer Locking System



Central Locking System W/Smart Foldable Key



Heavy Duty 5"x2" Anti-Slip & Shockproof TPR Casters with Lock



Compatible with All TOPTUL Drawer Insert Tool Sets



Large Arc-Shaped Side Handle



Tool Storage & Display

PRO-LINE SERIES

7-DRAWER

PRO-LINE SERIES TOOL TROLLEY

- 5 Medium & 2 Large Drawers
- High-Performance ABS Material Top Work Table
- Smooth Ball Bearing Slide Drawers with Auto-Return Function (full 100% retractable drawers)
- Only one drawer is opened at a time
- Smart Foldable Key
- New-Style Plastic Drawer Handle
- Electro-Powder Coating to Resist Scratch & Solvent Markings
- Heavy Duty 5"x2" Anti-Slip & Shockproof TPR Casters
- With Lock (2 Fixed Casters & 2 Swivel Casters with Lock)



ITEM NO.	SIZE(W)x(D)x(H)mm
TCAC0701	Overall: 687x459x857 Overall w/caster: 687x459x1015 5 Drawer: 578x378x75 2 Drawer: 578x378x155

7-Drawer Side Cabinet - GREEN



per cabinet includes 3 component trays

ITEM NO.	SIZE(W)x(D)x(H)mm
TBAI0701	Overall: 395x460x860 5 Drawer: 290x400x75 2 Drawer: 290x400x155

3-Drawer Middle Tool Chest

PRO-LINE SERIES GREEN



ITEM NO.	SIZE(W)x(D)x(H)mm
TBAD0301	Overall: 687x459x360 3 Drawer: 578x378x75

Side Cabinet - GREEN



Can Holder



Side Cabinet



Hanging Panel



Includes six types of hooks

per cabinet includes 30pcs of hooks (5pcs for each type of hook)

ITEM NO.	SIZE(W)x(D)x(H)mm
TBAH0101	325x460x860

GENERAL SERIES

GENERAL SERIES TOOL TROLLEY

- 5 Medium & 2 Large Drawers
- Smooth Ball Bearing Slide Drawers with Auto-Return Function (full 100% retractable drawers)
- 10mm EVA Material Top Mat
- Electro-Power Coating to Resist Scratch & Solvent Markings
- Standard 5"x2" PP Casters With Lock (2 Fixed Casters & 2 Swivel Casters with Lock)



7-Drawer Mobile Tool Trolley

7-Drawer Mobile Tool Trolley

GENERAL SERIES **RED**

7-Drawer Mobile Tool Trolley

GENERAL SERIES **GREEN**



ITEM NO.	SIZE(W)x(D)x(H)mm
TCAA0702	Overall: 687x459x857 Overall w/caster: 687x459x1015 5 Drawer: 578x378x75 2 Drawer: 578x378x155

ITEM NO.	SIZE(W)x(D)x(H)mm
TCAA0701	Overall: 687x459x857 Overall w/caster: 687x459x1015 5 Drawer: 578x378x75 2 Drawer: 578x378x155

3-Drawer Middle Tool Chest

GENERAL SERIES **GREEN**



ITEM NO.	SIZE(W)x(D)x(H)mm
TBAA0304	Overall: 687x459x360 3 Drawer: 578x378x75

Tool Storage & Display

□ Paper Roll Holder

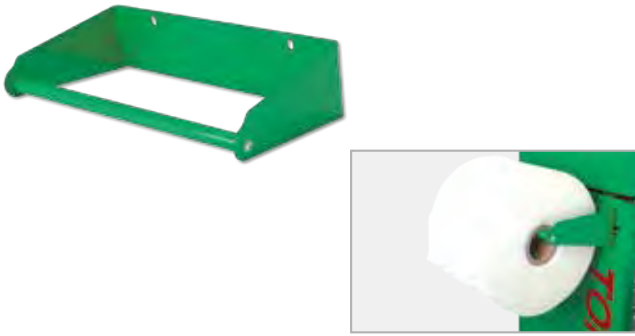

ITEM NO.	SIZE(W)x(D)x(H)mm
TEAL3703 (Green)	375x220x100

□ Can Holder



ITEM NO.	SIZE(W)x(D)x(H)mm
TEAL430103 (Green)	430x100x90

□ Folding Shelf



ITEM NO.	SIZE(W)x(D)x(H)mm
TAAE444501 (Green)	440x445x175

□ T-Handle Wrench Holder



ITEM NO.	SIZE(W)x(D)x(H)mm
TEAM3302 (Green)	330x100x60

HEAVY DUTY WORKBENCH

for most workshop applications

Heavy Duty Workbench & Wall Cabinet Series

Sturdy Construction for Heavy Duty Applications
 12mm Heavy Duty Rigid Working Table
 Cabinet Wall Panel Uses a Hole System for use with Hanging Hooks
 Electro-Powder Coating to Resist Scratch & Solvent Markings



per wall cabinet includes
 20pcs single hook - 2"(L)

□ Mechanical Tool

ITEM NO.	DESCRIPTION
1- TAAA1607	Heavy Duty Workbench - (W)1560x(D)710x(H)827 mm
2- TAAD1602	Heavy Duty Wall Cabinet - (W)1560x(D)200x(H)603 mm (per cabinet includes 20pcs single hook - 2")
3- TAAH1606	Heavy Duty Wall Panel - (W)1560x(H)600 mm (per panel includes 20pcs single hook - 2")
4- TBAA0304	3-Drawer Mobile Tool Chest - (W)687x(D)459x(H)360 mm
5- TCAB0501	Small 5-Drawer Tool Trolley - (W)569x(D)340x(H)769 mm

GENERAL SERIES

8-Drawer Heavy Duty Tool Chest



8-Drawer Heavy Duty Tool Chest
 Double Wall Construction
 Full Extension Drawer Load
 Heavy Duty Ball Bearing Slides
 Gas Struts Assisted Opening Lid

ITEM NO.	SIZE(W)x(D)x(H)mm
TBAA0801	Overall: 1052x471x523 4 Drawer: 569x398x75 4 Drawer: 308x398x75

13-Drawer Heavy Duty Mobile Work Station



ITEM NO.	SIZE(W)x(D)x(H)mm
TCBA1301	Overall: 1067x480x852 Overall w/caster: 1067x480x1011 1 Drawer: 935x398x120 5 Drawer: 569x398x75 1 Drawer: 569x398x155 5 Drawer: 308x398x75 1 Drawer: 308x398x155

5-Drawer Mobile Tool Trolley

GENERAL SERIES GREEN



ITEM NO.	SIZE(W)x(D)x(H)mm
TCAA0501	Overall: 687x459x722 Overall w/caster : 687x459x840 3 Drawer: 578x378x75 2 Drawer: 578x378x155

Small 5-Drawer Mobile Tool Trolley



ITEM NO.	SIZE(W)x(D)x(H)mm
TCAB0501	Overall: 569x340x661 Overall w/caster : 569x340x769 3 Drawer: 479x294x75 2 Drawer: 479x294x155

Tool Storage & Display

TOOL TROLLEY

TOOL CHESTS

1-Drawer Service Cart



ITEM NO.	SIZE(W)x(D)x(H)mm
TCAD0101	Overall: 690x470x815 1 Drawer: 578x378x75

3-Sections Portable Tool Chest



ITEM NO.	SIZE(W)x(D)x(H)mm
TBAC0501	470x220x350
TBAC0502 (Green)	470x220x350

3-Drawer Tool Chest



ITEM NO.	SIZE(W)x(D)x(H)mm
TBAA0303	508x232x302

6-Drawer Mobile Tool Chest

3 Small, 2 Medium & 1 Large Drawers Suitable For a Variety Of Storage Requirements



ITEM NO.	SIZE(W)x(D)x(H)mm
TBAA0601	Overall: 660x307x378 3 Drawer: 169x272x50 2 Drawer: 569x272x50 1 Drawer: 569x272x75

9-Drawer Mobile Tool Chest

6 small, 2 medium & 1 large drawers, suitable for a variety of storage requirements
Smooth ball bearing slide drawers with auto-return function
Include one portable tool tray & drawer liners



ITEM NO.	SIZE(W)x(D)x(H)mm
TBAA0901	Overall: 660x307x434 6 Drawer: 169x272x50 2 Drawer: 569x272x50 1 Drawer: 569x272x75

Tool Box (SMALL)



Tool Box (MEDIUM)



ITEM NO.	SIZE(W)x(D)x(H)mm
TBAE0201	380x178x143

ITEM NO.	SIZE(W)x(D)x(H)mm
TBAE0301	445x240x202

TOPTUL Tool Bag W / Steel Tube Handle

- NEW

- Rigid, Waterproof Tool Compartment
- Elastic Tool Retaining Strap
- Large Number of Side Pockets
- Removable Padded Shoulder Strap
- Material: Fabric Polyester
- Loading Capacity: Max. 30kg
- Dimensions (L. x W. x H.): 41 x 28 x 30 cm
- Net Weight: 2.7 kg



ITEM NO.	SIZE(L)x(W)x(H)mm
PBW-041A	410x280x300

TOPTUL®

THE MARK OF PROFESSIONAL TOOLS

the choice of professionals

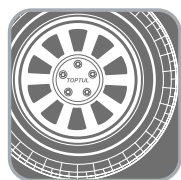

Auto Tools Series
Undercar / Engine / Body / General Tools
Automotive

specialty tools for auto mechanical repairs & maintenance.

AUTO TOOLS SERIES



150

PROFESSIONAL HAND TOOLS

3PCS
1/2" DR. Hub Nut Deep Impact Socket Set

CR-MO



- Heavy duty, professional quality 12-point deep impact sockets manufactured from hardened and tempered Chrome Molybdenum Steel
- Suitable for hub nut applications where high torque is required
- Set contains three sockets for a sure grip on the most common sized hub nuts
- Black phosphate finish for added corrosion resistance
- Applications: Audi, VW, Alfa, BMW, Citroen, Fiat, Ford, Mercedes, Opel, Peugeot, Renault and etc.

ITEM NO.	CONTENTS	📦
GDAI0303	3 KABJ1630~1636 1/2" Dr. 12PT Flank Deep Impact Sockets (78mmL) 30, 32, 36 mm	10 (SET)

BLOW CASE: W170 x D105 x H70 (mm)					
DRIVE	ITEM NO.	SIZE (mm)	L (mm)	QTY	📦
1/2" 12.7mm sq.	KABJ1630	30	78	1	N/A
	KABJ1632	32	78	1	N/A
	KABJ1636	36	78	1	N/A

18PCS
Universal Caliper Disc Brake Wind Back Tool Kit



- This tool is designed to wind back brake caliper pistons when servicing brake calipers or replacing brake pads
- Expert Quality, left hand and right hand threaded rewind tools allow the easy return of the brake piston into the caliper to provide clearance for new brake pads
- Application for most cars, such as Audi, Ford, Nissan, Alfa Romeo, Saab, Subaru, BMW, Toyota, Jaguar, VW, GM and etc.

ITEM NO.	CONTENTS	📦
JGAI1801	2 Left and right hand threaded rewind tools 1 Reaction plate 15 Brake piston adapters	8 (SET)

BLOW CASE: W325 x D255 x H50 (mm)

6PCS
1/2" DR. Spline Impact Socket Bit Set

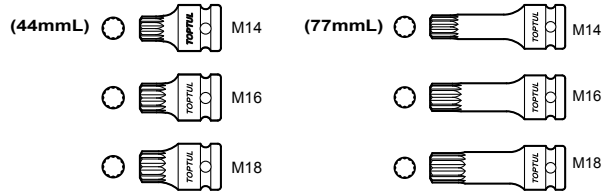

- Expert quality, tempered and hardened Nickel Chrome Molybdenum Steel (SNCM+V) socket bits
- Spline bit M14/M16/M18, each size in two lengths 44 & 77 mmL
- Suitable for removal and adjustment of hubs, steering and suspension on VAG vehicles and etc.
- Use with 1/2" square drive impact tools
- Black phosphate finish for extended corrosion resistance

ITEM NO.	CONTENTS	📦
GDAI0601	3 KADB1614S~KADB1618S 1/2" Dr. Spline Bit Impact Sockets (44mmL) M14, M16, M18 3 KADB1614L~KADB1618L 1/2" Dr. Spline Bit Impact Sockets (77mmL) M14, M16, M18	20 (SET)

BLOW CASE: W130 x D107 x H53 (mm)

3/4" DR. Spline Bit Impact Socket

Black Phosphate Finished CR-MO



- Made of impact quality Chrome Molybdenum Alloy Steel
- This tool is designed to loosen and tighten wheel bearing / hub unit retaining bolts at the rear axle
- Applicable: AUDI A3, VW Golf Plus, Jetta, Touran, Eos, Passat, SEAT Altea, Leon, Toledo and etc.

DRIVE	ITEM NO.	SIZE	L(mm)	📦	📦
3/4" 19.0mm sq.	KADB2418	M18	105	1	18

Auto Tools - Undercar Series

CV Boot Clamp Pliers - Ear Type



- Designed to crimp the ear-type CV boot clamps used on front-wheel drive vehicles
- Pliers serve as a hose clamp installer for easy installation of Perma-Quick type hose clamps on fuel filters, water pumps, other cooling system hoses and CV joint boot clamps
- Comfort grip handle

ITEM NO.	LENGTH (mm)		
JEAE0310	265 (10-1/2")	12	48

Wheel Balancing Weight Pliers With Invisible Spring

CR-V



- Special tool for balancing automotive tires and wheels; installs, removes, trims, levers, hammers and tightens all type of click-on wheel weights

ITEM NO.	LENGTH (mm)		
JEAA1010	250 (10")	10	40

Fork Type Ball Joint Separator

CR-MO



- Tempered drop forged steel with one piece construction for long and rough usage
- Robust fork with long length stem replaces worn out ball joints easily with a hammer striking

ITEM NO.	FORK OPENING (mm)	L(mm)		
JEAB0330	24	300	10	20
JEAB0440	18	400	10	20

Clic-R Collar Pliers

CR-MO

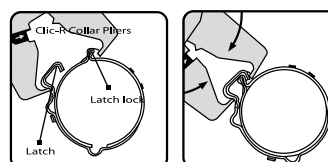

- For releasing and refitting the new style Clic and Clic-R reusable hose clamp clips
- Spring actuated joint, soft grip handles

ITEM NO.	LENGTH (mm)		
JEAE0107	180 (7")	12	72

Universal Ball Joint Separator

CR-MO

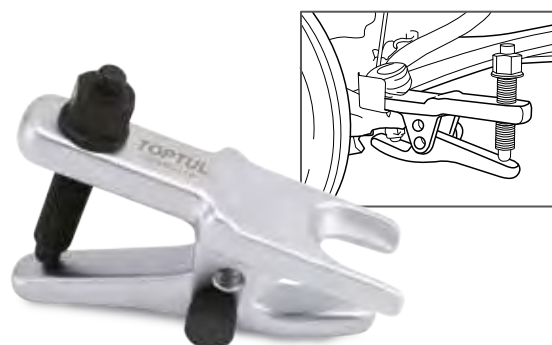

- Drop forged steel body and bolt for long and rough usage
- Special design two stage operation provides 30mm & 55mm maximum opening
- Suitable for most small cars and light trucks ball joints in steering and suspension

ITEM NO.	JAW SIZE (mm)	MAX. JAW OPENING (mm)	L (mm)		
JEAB0216	22	55	160	1	20

Tire Lever

CR-V



- For tire mounting and removing

ITEM NO.	LENGTH (mm)		
JCAB2821	530 (21")	10	20

■ Spline Alternator Combination Bit Socket (M10)

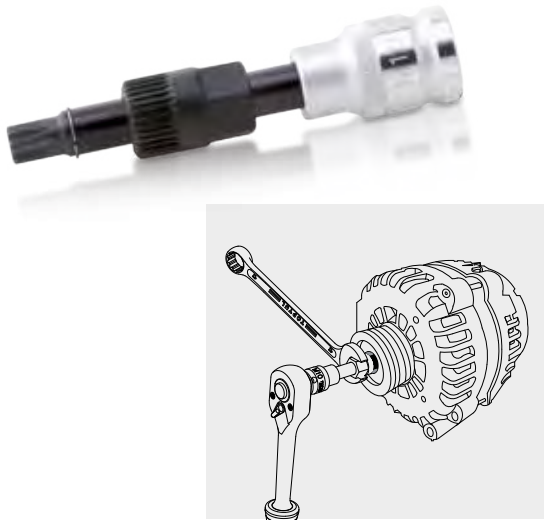

- The two-part alternator socket allows easy removal and replacement of the free-wheel drive pulley at the alternator
- This tool allows the alternator to be locked by the M10 spline bit socket insert and enables the central locking bolt of the pulley to be loosened or tightened by the serrated reaction nut
- Use with 17mm wrench
- 33 teeth hexagonal reaction nut, O.D. 19.5mm
- Applications: BMW, VW, Audi, Ford, Skoda, Mercedes, Porsche, Renault and etc.

ITEM NO.	DRIVE	SIZE	Teeth	● (mm)	L(mm)		
JDCD3310	1/2"	M10	33	17	110	10	80

■ V-Belt Pulley Remover

CR-V



- Made of Chrome Vanadium Alloy Steel
- Special design to stop the pulley and remove the centre bolts for removing and installing the V-belt pulley at the generator
- Use with 17mm wrench and spline bit socket (M10) to remove and install the socket
- Applicable/VW Golf 3, Vento, Passat, AUDI A3, VOLVO and etc.

ITEM NO.	Teeth	● (mm)	O.D. Ø (mm)	I.D. Ø (mm)	L (mm)		
JDBD3317	33	17	19.5	11.8	30	10	180

■ 1/2" DR. Oil Drain Plug Socket

Black Phosphate Finished (SNCM+V)



- Made of expert quality, hardened and tempered Chrome Molybdenum Steel Material
- A special 12 point (triple square) tamperproof socket used to remove the transmission drain plug
- Tamperproof design for removing and installing the oil release bolts/screws on the transmission and gearbox
- Application: Audi A4-A6, VW Passat, Porsche Boxster and etc.

ITEM NO.	DRIVE	SIZE	L(mm)		
JDBC1616	1/2"	M16H	60	10	60

■ 3/8" DR. Deep Spark Plug Socket

CR-V

- Professional quality, 12-point deep sockets manufactured from hardened and tempered Chrome Vanadium Steel
- Designed for easy installation or removal of the deep-seated (deeply recessed) spark plugs
- Fitted with a rubber insert for plug protection and retention
- Knurled finger grips for hand starting
- Polished chrome plated

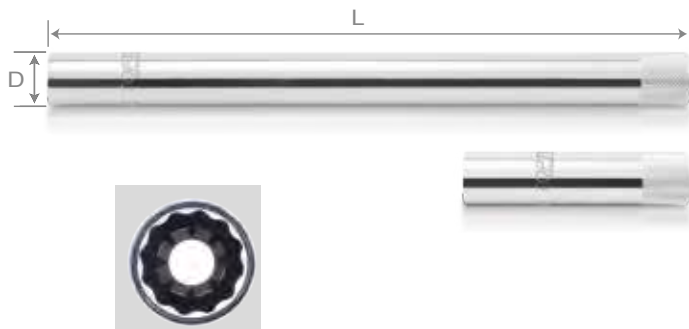

- Rubber insert for positive plug protection and retention

DRIVE	ITEM NO.	SIZE(mm)	L(mm)	D(mm)	Mirror Finished	
	Mirror					
3/8"	BSBA1214S	14	90	20	10	160
	BSBA1214L	14	250	19	5	40

■ Heavy Duty Seal Puller



- Removes Oil & Grease Seals
- Two Tips Fit Most Application

ITEM NO.	LENGTH (mm)		
JDAK0132	318 (12-1/2")	12	48

Auto Tools - Engine Series

16PCS

Automotive Cup Type Oil Filter Wrench Set



Suitable for European Vehicles

ITEM NO.	CONTENTS	5 (SET)
JGAI1601	1 66mm (2-19/32") - 6 Flutes-1 Step	
	1 74~76mm (2-29/32"-3") - 15 Flutes-1 Step	
	1 76mm (3") - 8 Flutes-1 Step	
	1 76mm (3") - 12 Flutes-1 Step	
	1 76mm (3") - 14 Flutes-1 Step	
	1 86mm (3-3/8") - 16 Flutes-1 Step	
	1 86mm (3-3/8") - 18 Flutes-1 Step	
	1 92mm (3-40/64") - 10 Flutes-1 Step	
	1 93mm (3-21/32") - 15 Flutes-1 Step	
	1 93mm (3-21/32") - 45 Flutes-1 Step	
	1 96mm (3-3/4") - 18 Flutes-1 Step	
	1 106mm (4-11/64") - 15 Flutes-1 Step	
	1 108mm (4-8/32") - 15 Flutes-1 Step	
	1 108mm (4-8/32") - 18 Flutes-1 Step	
	1 3 Legged Oil Filter Tool	
	65~120mm (2-1/2"-4-3/4")	
1 Adaptor - 1/2"(F)x3/8"(M) Drive		

BLOW CASE: W440 x D320 x H90 (mm)

Strap Wrench



ITEM NO.	CAPACITY Ø (mm)	L(inch)	10	60
JJAH0902	30~160	9	10	60

3-Legged Oil Filter Wrench



Filter Capacity: 65-120mm (2-1/2" to 4-3/4")
Removes all sizes of oil filters from 65 to 120mm in diameter
Use with 1/2" or 3/8" square drive tool or 21mm wrench/socket
Suitable for most cars and light trucks

ITEM NO.	CAPACITY Ø (mm)	12	48
JDAI65A2	65~120 (2-1/2"~4-3/4")	12	48

Nylon Strap Oil Filter Wrench

Removes any oil filters up to a 6" (152mm) diameter
Strong, non-slip nylon webbing strap
Use with 1/2" square drive tools



ITEM NO.	MAX. CAPACITY Ø (mm)	12	48
JDAV1615	152 (6")	12	48

Professional Swivel Handle Oil Filter Wrench

Heavy duty oil filter wrench
Swivel handle allows user to reach filters in hard to reach places
Wide band securely grips filters without crushing
Easy grip comfortable handle

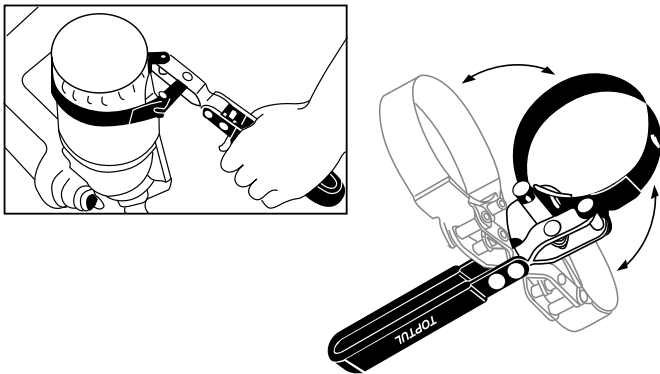

ITEM NO.	CAPACITY Ø (mm)		
JDAU6073	60 ~ 73 (2-3/8" ~ 2-7/8")	6	36
JDAU7385	73 ~ 85 (2-7/8" ~ 3-3/8")	6	36
JDAU8595	85 ~ 95 (3-3/8" ~ 3-3/4")	6	36
JDAU95B0	95 ~ 110 (3-3/4" ~ 4-3/8")	6	36

Chain Wrench



Tempered and hardened high-grade tool steel chain and body
Double-hinge construction for high clamping power
Ratchet-style action design works in both directions
Flexible handle enables to work in narrow spaces
Ideal for automotive oil filter replacement
Chain length: 350mm (14")

ITEM NO.	CAPACITY Ø (mm)	L(mm)		
JDBA60A5	60~105	225	5	20

Oil Filter Master Plier

High quality Chrome Vanadium Alloy Steel
Professional heat treated and machined
Adjustable locking pliers design filter wrench
Nickel plated finish
Jaws Opening Range: 2-1/8" to 4-5/8" (53mm-118mm)

CR-V



ITEM NO.	SIZE(inch)		
DMAC1A10	10	12	48

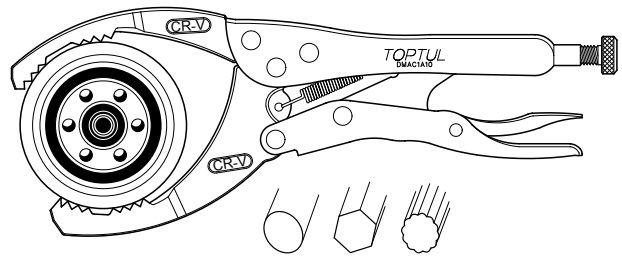

Multi-Purpose Plier

Suitable for installing, removing and tightening objects of any shape.

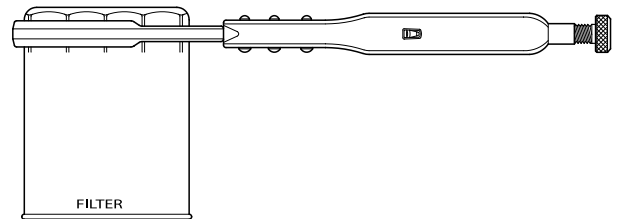

This plier can be adjusted and fastened for applications at any angle.

Oil Filter Pliers

Drop forged pliers body for strength
3 position slip-joint design
Serrated jaws and long handles for extra grip



ITEM NO.	SIZE(inch)	CAPACITY Ø (mm)		
JDAA1010	10	60~90 (2-3/8"~3-1/2")	10	40
JDAA1212	12	57~110 (2-1/4"~4-5/16")	10	40

Auto Tools - Engine Series

Curved Hose Clamp Pliers

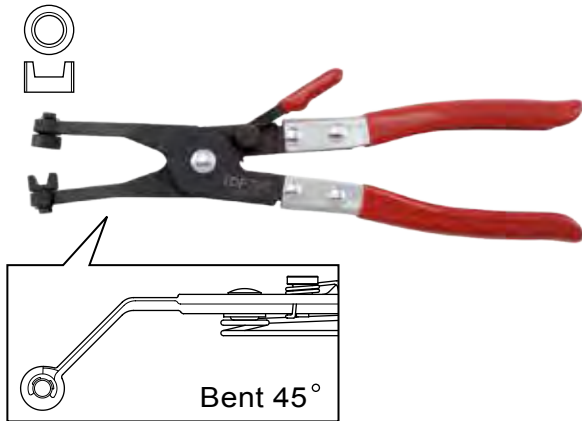

Finger tip "position lock" design for easy replacement of lower radiator hose 45° bending design to fit clamps in deep position

ITEM NO.	LENGTH (mm)		
JDAM039C	235 (9-1/4")	6	48

Hose Clamp Pliers



Finger tip "position lock" design for easy replacement of lower radiator hose

ITEM NO.	LENGTH (mm)		
JDAM028E	215 (8-1/2")	6	60

3PCS

Flexible Line Clamp Set



ITEM NO.	CONTENTS		
JGAR0301	1 JDAY0119 Small Line Clamp - Ø 6~19 mm (1/4"~3/4")	10 (SET)	
	1 JDAY0132 Medium Line Clamp - Ø 13~32 mm (1/2"~1-1/4")		
	1 JDAY0157 Large Line Clamp - Ø 19~57 mm (3/4"~2-1/4")		

Piston Ring Pliers

Made of high grade special tool steel
For installing and removing piston rings
Bright nickel-plated

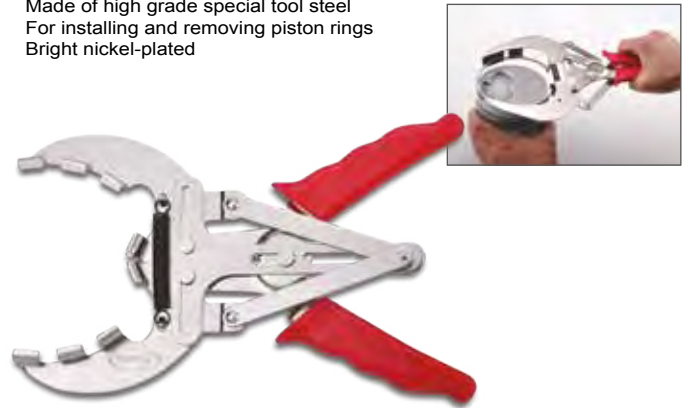

ITEM NO.	CAPACITY Ø (mm)	L(mm)		
JABA0510	50~100	215	12	48
JABA0812	80~120	225	12	48
JABA1116	110~160	255	12	48

Piston Ring Compressor

(SUS)



ITEM NO.	HEIGHT (inch)	CAPACITY (mm)		
JAAA1303	3	53~125	30	60
JAAA1804	4	90~175	30	60
JAAA1806	6	90~175	20	40

Valve Spring Compressor



Reversible jaw adapter for multi-valve engines
Dual size in adapter 25mm & 30mm adapter

ITEM NO.	CAPACITY (mm)		
JDAN0143	35~200	3	6



▣ Straight Tip Lock Ring Pliers



- Used to spread snap rings found on brakes, pedal shaft, transmissions, clutch shafts, machine tools, and some piston rings
- Jaws are scored on outside for secure gripping
- Drop forged alloy steel, spring loaded joint, comfort grip handle

ITEM NO.	LENGTH (mm)	SPREAD (mm)		
JDAP0109	215 (8-1/2")	25 (1")	6	72

▣ Angle Tip Lock Ring Pliers



ITEM NO.	LENGTH (mm)	SPREAD (mm)		
JDAP0209	215 (8-1/2")	25 (1")	6	72

▣ Pulley Removing Wrench

- To lock the pulley during removing or assembling any type of pulley retaining bolt
- High flexibility outperforms the traditional standard strap or chain wrench, and will not damage components
- Ideal for water pump, alternator pulleys and various electric motor pulleys of compressors, washing machines, tool machines and etc.
- Also suitable to rotate the cam shaft when timing the engine and to remove oil and gasoline filters



JDAF1437:V-Belt Pulleys



JDAG1437:Poly-V Belt Pulleys

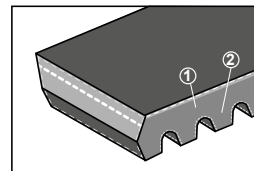
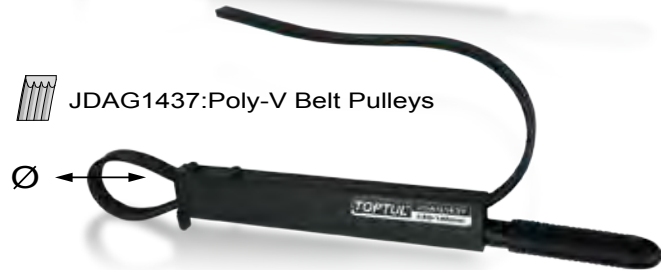

1. Cord Tension
Low elongation stiff cord is highly resistant to tension and resulting in better power transmission.
2. Rib Rubber
Fiber-contained rubber is greatly resistant to abrasion and breakage.

JDAF1437
V-Belt Pulleys

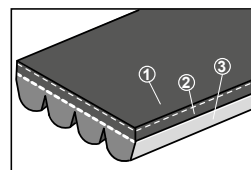

1. Cover Fabric
Flexible fabric material is resistant to breakage and high temperature and oil-based substances.
2. Cord Tension
Low elongation stiff cord is highly resistant to tension and resulting in better power transmission.
3. Rib Rubber
Fiber-contained rubber is greatly resistant to abrasion and breakage.

JDAG1437
Poly-V Belt Pulleys

ITEM NO.	CAPACITY Ø (mm)	LENGTH(mm)		
JDAF1437	40-140	365 (14-3/8")	12	36
JDAG1437	40-140	365 (14-3/8")	12	36

Auto Tools - Body Series

4PCS

Miniature Hook & Picks Set

(SUS)



ITEM NO.	CONTENTS	📦 10 (SET)
GAAR0401	JJAK0301 Mini - Awl	
	JJAK0303 Mini - Hook	
	JJAK0304 Mini - Bent Tip 45°	
	JJAK0302 Mini - Bent Tip 90°	

Cotter Pin Puller

(CR-V)

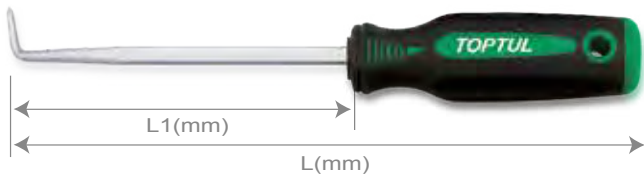

ITEM NO.	L1(mm)	L(mm)	📦 5	📦 40
JJAK0101	125	235		

Radiator Hose Remover

(CR-V)



ITEM NO.	L1(mm)	L(mm)	📦 5	📦 40
JJAK0201	80	190		

Scraper

(CR-V)



ITEM NO.	L1(mm)	L(mm)	📦 5	📦 40
JJAJ0813	125	245		

Door Upholstery Remover

(CR-V)

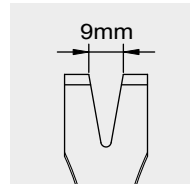

ITEM NO.	L1(mm)	L(mm)	📦 5	📦 40
JJAE1011	110	230		

Door Upholstery Remover

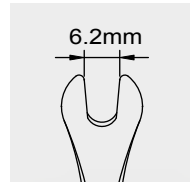

- Blade made from special high quality SVCM tool steel
- Rugged tool with a large comfortable bi-component PP+TPR plastic handle
- Removes plastic door panel fasteners without breakage

ITEM NO.	L1(mm)	L(mm)	📦 5	📦 40
JJAE0612	115	225		

Door Upholstery Remover

(CR-V)

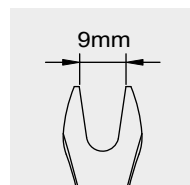

- For plastic upholstery fasteners
- Place tool under edge of door panel and insert into fastener as then simply pry up

ITEM NO.	L1(mm)	L(mm)	📦 10	📦 40
JJAE0812	120	245		

Stainless Steel Putty Knife (Flexible Scraper)

(SUS)



ITEM NO.	BLADE SIZE (WxL) (mm)	BLADE THICKNESS (mm)		
JDAB3205	32x100	0.5	10	180
JDAB5005	50x100	0.5	10	180
JDAB7605	76x100	0.5	8	144

3PCS

Stainless Steel Putty Knife Set



ITEM NO.	CONTENTS	
JGAT0301	1 76x100x0.5 mm 1 50x100x0.5 mm 1 32x100x0.5 mm	20 (SET)

Stainless Steel Bolstered Scraper

(SUS)

- Straight Blade
- Bent Blade
- Straight Blade



ITEM NO.	BLADE SIZE (WxL) (mm)	BLADE THICKNESS (mm)		
JDAD3218	32x100	1.8	10	180
JDAE3218	32x100	1.8	10	180
JDAD5018	50x100	1.8	10	180

3PCS

Stainless Steel Bolstered Scraper Set



ITEM NO.	CONTENTS	
JGAT0302	1 50x100x1.8 mm Straight Blade 1 32x100x1.8 mm Bent Blade 1 32x100x1.8 mm Straight Blade	20 (SET)

Stainless Steel Pinchweld Scraper

(SUS)



ITEM NO.	BLADE SIZE (WxL) (mm)	BLADE THICKNESS (mm)		
JDAD3225	32x100	2.5	10	180
JDAC2012	20x50	1.2	10	180
JDAC2025	20x50	2.5	10	180
JDAD3212	32x100	1.2	10	180

4PCS

Stainless Steel Pinchweld Scraper Set



ITEM NO.	CONTENTS	
JGAT0401	1 32x100x2.5 mm 1 20x50x1.2 mm 1 20x50x2.5 mm 1 32x100x1.2 mm	20 (SET)

Auto Tools - Body Series

Curved Dolly



ITEM NO.	W(mm)	H(mm)	L(mm)		
JFBA0108	58	70	80	4	12

Double End Round Dolly



ITEM NO.	W(mm)	L(mm)		
JFBD0106	∅56	58	6	12

Heel Dolly



ITEM NO.	W(mm)	H(mm)	L(mm)		
JFBH0107	61	30	79	6	24

Curved Dolly



ITEM NO.	W(mm)	H(mm)	L(mm)		
JFBI0113	58	45	133	6	12

Utility Dolly



ITEM NO.	W(mm)	H(mm)	L(mm)		
JFBH0107	73	66	76	6	12

Angle Dolly

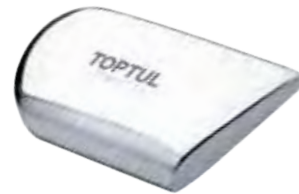

ITEM NO.	W(mm)	H(mm)	L(mm)		
JFBI0111	59	16	108	6	24

Double End Hand Dolly



ITEM NO.	W(mm)	H(mm)	L(mm)		
JFBD0208	62	75	66	6	12

Toe Dolly



ITEM NO.	W(mm)	H(mm)	L(mm)		
JFBG0112	58	29	121	6	12

Anvil Dolly



ITEM NO.	W(mm)	H(mm)	L(mm)		
JFBB0110	72	62	102	4	16

Thin Toe Dolly



ITEM NO.	W(mm)	H(mm)	L(mm)		
JFBG0212	55	24	118	6	24

Shrinking Dolly



ITEM NO.	W(mm)	H(mm)	L(mm)		
JFBG0412	58	29	120	6	12

Grid Dolly



ITEM NO.	W(mm)	H(mm)	L(mm)		
JFBG0312	58	30	120	6	12

Large End Dolly



ITEM NO.	W(mm)	H(mm)	L(mm)		
JFBE0113	70	125	90	4	16

Round Peen End Dolly



ITEM NO.	W(mm)	H(mm)	L(mm)		
JFBC0113	44	Ø54	125	6	24

Double Blade Spoon



ITEM NO.	W(mm)	H(mm)	L(mm)		
JFCC0140	58	172	401	4	8
JFCC0251	59	179	510	2	8

Anvil Dolly



ITEM NO.	W(mm)	H(mm)	L(mm)		
JFBE0215	67	146	139	2	12

Dome Dolly



ITEM NO.	W(mm)	H(mm)	L(mm)		
JFBE0315	61	30	155	2	16

Light Dinging Spoon



ITEM NO.	W(mm)	H(mm)	L(mm)		
JFCA0127	48	58	250	12	72

Drip Moulding Spoon



ITEM NO.	W(mm)	H(mm)	L(mm)		
JFCD0124	49	70	235	6	12

Flat Spoon



ITEM NO.	W(mm)	H(mm)	L(mm)		
JFCB0125	30	99	250	12	48
JFCB0229	51	68	286	6	24

Auto Tools - Body Series

HAMMER HAMMER

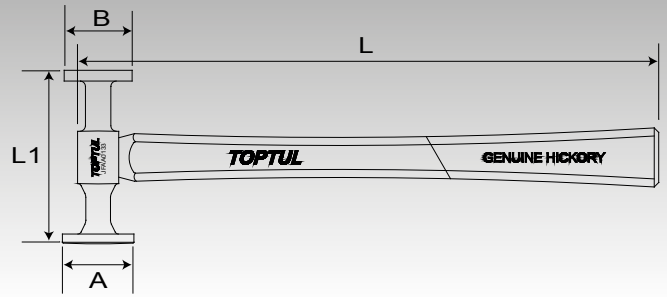

Heavy Shrinking Hammer

- Flat Face + Shrink Milled Square Face

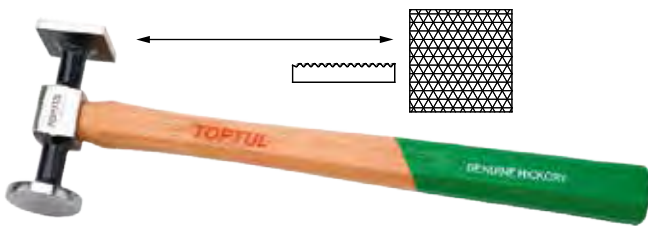

ITEM NO.	A(mm)	B(mm)	L1(mm)	L(mm)		
JFAB0133	Ø40	38x38	100	325	6	36

Standard Bumping Hammer

- Crowned Face



ITEM NO.	A(mm)	B(mm)	L1(mm)	L(mm)		
JFAA0233	Ø40	38x38	98.5	325	6	36

Light Shrinking Hammer

- Flat Face + Milled Square Face

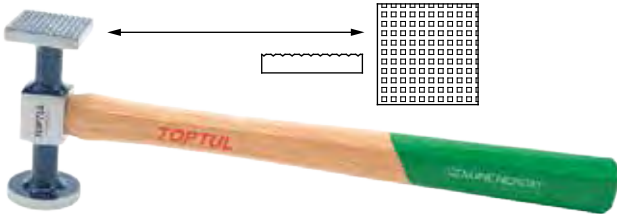

ITEM NO.	A(mm)	B(mm)	L1(mm)	L(mm)		
JFAB0233	Ø40	38x38	100	325	6	36

Light Bumping Hammer

- Flat Face



ITEM NO.	A(mm)	B(mm)	L1(mm)	L(mm)		
JFAA0333	Ø32	25x25	91	325	6	36

Standard Bumping Hammer

- Flat Face



ITEM NO.	A(mm)	B(mm)	L1(mm)	L(mm)		
JFAA0133	Ø40	38x38	100	325	6	36

Light Bumping Hammer

- Crowned Face



ITEM NO.	A(mm)	B(mm)	L1(mm)	L(mm)		
JFAA0433	Ø32	25x25	91	325	6	36

Reverse Curve Hammer
- Crowned Face



ITEM NO.	A(mm)	B(mm)	L1(mm)	L(mm)		
JFAA0533	Ø29.5	25.5x25.5	104	325	6	36

Curved Pein & Finishing Hammer
- Crowned Face



ITEM NO.	A(mm)	L1(mm)	L(mm)		
JFAC0233	Ø40	140	325	6	36

Pick & Finishing Hammer
- Crowned Face



ITEM NO.	A(mm)	L1(mm)	L(mm)		
JFAC0333	Ø40	138	325	6	36

Straight Pein & Finishing Hammer
- Crowned Face



ITEM NO.	A(mm)	L1(mm)	L(mm)		
JFAC0133	Ø40	141	325	6	36

7PCS Professional Grade
Auto Body Repair Tool Set



- Professional quality meets industrial standards
- Drop forged tool steel dollies, heat treated, includes Utility Dolly, Curved Dolly, Heel Dolly and Toe Dolly
- Drop forged tool steel hammers, selected hickory, includes Pick & Finishing Hammer, Shrinking Hammer and Standard Bumping Hammer
- Easy latch case holds all tools securely in place and provides excellent tool protection

ITEM NO.	CONTENTS		3 (SET)
GAAI0702	1 JFAB0233 - Light Shrinking Hammer (Flat Face + Milled Square Face)		
	1 JFAA0133 - Standard Bumping Hammer		
	1 JFAC0333 - Pick & Finishing Hammer(Crowned Face)		
	1 JFBI0113 - Curved Dolly		
	1 JFBG0112 - Toe Dolly		
	1 JFBJ0108 - Heel Dolly		
	1 JFBH0107 - Utility Dolly		



BLOW CASE: W478 x D234 x H100 (mm)

Auto Tools - General Tools Series

■ Magnetic Car Fender Cover W/Pockets



- Perfect for engine repair jobs to avoid paintwork damages
- 8 pieces high powered magnets for sure grip
- 4 tool holding pockets with a maximum loading weight up to 1.5kg

ITEM NO.	SIZE (W)x(L)		
JJAQ1106	1070x600 mm (42"x23-1/2")	1	12

■ Mechanic's Roller Seat

- Practical mechanic's roller work seat
- Durable powder coated steel frame
- Foam cushioned seat with wipe clean surface
- Seat cushion is removable and can be used as a great kneeling pad
- Bottom storage area provides easy and quick access to miscellaneous tools and parts
- Perfect height for wheel, brake or body works and all kind of low repair jobs
- 4 long-wearing 2" high impact poly swivel casters
- Maximum seat height: 305mm
- Seat area: 350x200 mm
- Maximum loading capacity up to 120 kg



ITEM NO.	SIZE (L)x(W)x(H)mm	
JCA-350A	350x300x305	1

■ Plastic Creeper

- Rigid molded, one piece plastic construction
- Shaped arm areas for optimal movement freedom
- Padded head support
- Two built-in tool trays (right & left)
- Six 3" PU swivel caster wheels for easy maneuverability
- Practical hand carry handle
- Maximum load: 135 kg



ITEM NO.	SIZE (L)x(W)x(H)mm	
JCM-03	1020x480x115	1

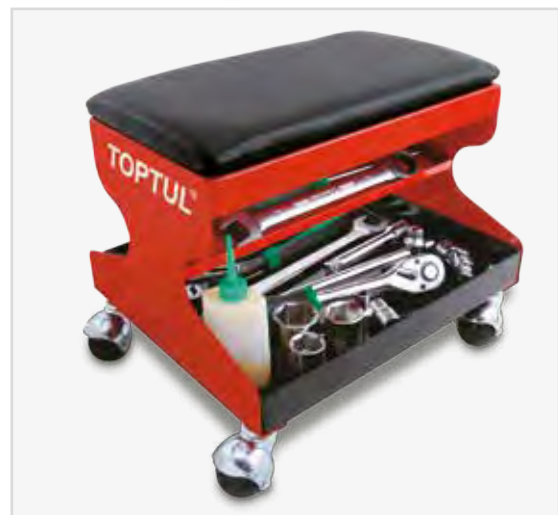

Other Tools Series

Essential

mechanical tools include pullers, crimping tools & bolt cutters.

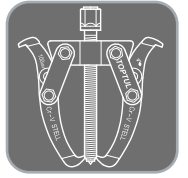

OTHER TOOLS SERIES



Other Tools



- Crimping tool set with ratcheting function and adjustable jaws
- Includes 5 exchangeable crimping jaws
- Insulated terminal ends DIN 0.5-6mm²
- Non-insulated terminal ends DIN 1.5-10mm²
- Open-barrel terminal ends DIN 0.5-6mm²
- Insulated cord-End Terminals ends DIN 0.5-4.0mm²(for small size)
- Insulated cord-End Terminals ends DIN 6-16mm²(for large size)

6PCS

Quick Interchangeable Ratchet Crimping Tool Kit

- Ratchet mechanism crimper stands for superior labor saving
- Quick insertion changing of jaw without any tool
- Professional AISI 4140 Alloy Steel Crimping Jaws
- Ergonomic comfort-grip handle



ITEM NO.	CONTENTS	10 (SET)
GAAI0605	1 DKBA2222 Quick Interchangeable Ratchet Crimper	
	1 DLAA0601 Insulated Terminal DIN 0.5-1.0/1.5-2.5/4-6 mm ²	
	1 DLAA1001 Non-Insulated Terminal DIN 1.5/2.5/6/10 mm ²	
	1 DLAA0602 Open-Barrel Terminal DIN 0.5-1.0/1.5-2.5/4-6 mm ²	
	1 DLAA0401 Insulated Cord-End Terminal (for small size) DIN 0.5/0.75/1.0/1.5/2.5/4.0 mm ²	
	1 DLAA1601 Insulated Cord-End Terminal (for large size) DIN 6/10/16 mm ²	

BLOW CASE: W280 x D195 x H50 (mm)

A Jaw for insulated terminal



Surface treatment

- Procedure: Precision and Wax-lost Casting.
- Treatment: Finished with heat treatment (HRC 38 - 45).
- Zinc Phosphate Surface Treatment.

Material

- Material: AISI 4140.

Suitable for

- AWG 22-18/16-14/12-10
- DIN 0.5-1.0/1.5-2.5/4-6mm²



B Jaw for non-insulated terminal



Surface treatment

- Procedure: Precision and Wax-lost Casting.
- Treatment: Finished with heat treatment (HRC 38 - 45).
- Zinc Phosphate Surface Treatment.

Material

- Material: AISI 4140.

Suitable for

- AWG 20-18/16-14/12-10/8
- DIN 1.5/2.5/6/10mm²
- JIS 1.25/2/5.5/8mm²



C Jaw for open-barrel terminal



Surface treatment

- Procedure: Precision and Wax-lost Casting.
- Treatment: Finished with heat treatment (HRC 38 - 45).
- Zinc Phosphate Surface Treatment.

Material

- Material: AISI 4140.

Suitable for

- AWG 20-18/16-14/12-10
- DIN 0.5-1.0/1.5-2.5/4-6mm²



▣ Ratchet Crimping Tool for Non-Insulated Terminal

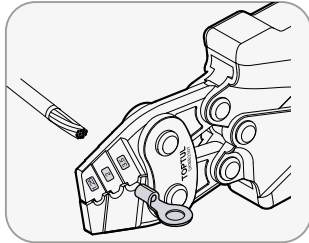

- Expert quality, chrome molybdenum steel with hardened and tempered jaws
- Continuous crimping at preset tension ensures accurate and effective crimp
- Ratchet action ensures consistent crimp tension
- Comfortable and soft plastic anti-slip grip handle
- Suitable for most non-insulated terminals

ITEM NO.	CAPACITY (mm ²)	L (mm)		
DKBB2307	1.25 - 2 - 3.5 (AWG 22-12)	170	6	72

▣ Ratchet Crimping Tool for Non-Insulated Terminal

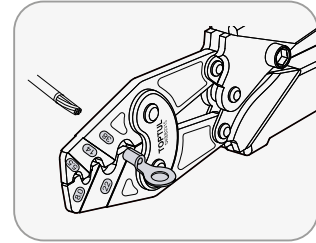

- Expert quality, chrome molybdenum steel with hardened and tempered jaws
- Continuous crimping at preset tension ensures accurate and effective crimp
- Ratchet action ensures consistent crimp tension
- Comfortable and soft plastic anti-slip grip handle
- Suitable for most non-insulated terminals

ITEM NO.	CAPACITY (mm ²)	L (mm)		
DKBB2315	5.5 - 8 - 14 - 22 - 38 (AWG 12-2)	380	1	12

▣ Multi-Purpose Crimping Pliers



ITEM NO.	CAPACITY	
DIBB2009	Insulated terminals 1.5, 2.5, 4, 6 mm ² Bolt cutter M2.6, M3, M3.5, M4, M5 Open barrel terminals 1.5, 2.5, 4-6 mm ² Wire stripper 0.75, 1.0, 1.5, 2.5, 4.0, 6.0 mm ² (with integral wire-cutter)	10

▣ Multi-Purpose Crimping Pliers



ITEM NO.	CAPACITY	
DIBB1009	Insulated terminals 1.5, 2.5, 4, 6 mm ² Bolt cutter M2.6, M3, M3.5, M4, M5 Non-insulated terminals 1.5, 2.5, 4-6 mm ² Wire stripper 0.75, 1.0, 1.5, 2.5, 4.0, 6.0 mm ² (with integral wire-cutter)	10

D Jaw for cord-end insulated terminal (For small size)



Surface treatment

- Procedure: Precision and Wax-lost Casting.
- Treatment: Finished with heat treatment (HRC 38 - 45).
- Zinc Phosphate Surface Treatment.

Material

- Material: AISI 4140.

Suitable for

- AWG 22/20/18/16/14/12
- DIN 0.5/0.75/1.0/1.5/2.5/4.0mm²



F Jaw for cord-end insulated terminal (For large size)



Surface treatment

- Procedure: Precision and Wax-lost Casting.
- Treatment: Finished with heat treatment (HRC 38 - 45).
- Zinc Phosphate Surface Treatment.

Material

- Material: AISI 4140.

Suitable for

- AWG 10/8/6
- DIN 6/10/16 mm²



Other Tools

Industrial Lever Riveter



- 4 Interchangeable nosepieces
- Rivet steering capacity: 3.2mm (1/8"), 4.0mm (5/32")
4.8mm (3/16"), 6.4mm (1/4")
- Rivet material: Steel / Aluminum / Copper / Stainless Steel
- Length: 450mm (17-1/2")
- Material: Aluminum body, steel tube with rubber handle
- Lever design reduces physical strength for all rivet sizes
- Extra long handle provides excellent leverage

ITEM NO.	RIVET DIAMETER(mm)		
JBAB3264	3.2(1/8"), 4.0(5/32"), 4.8(3/16"), 6.4(1/4")	1	12

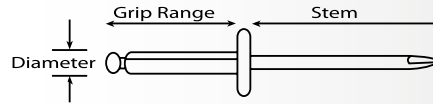

Scissor Action Industrial Riveter

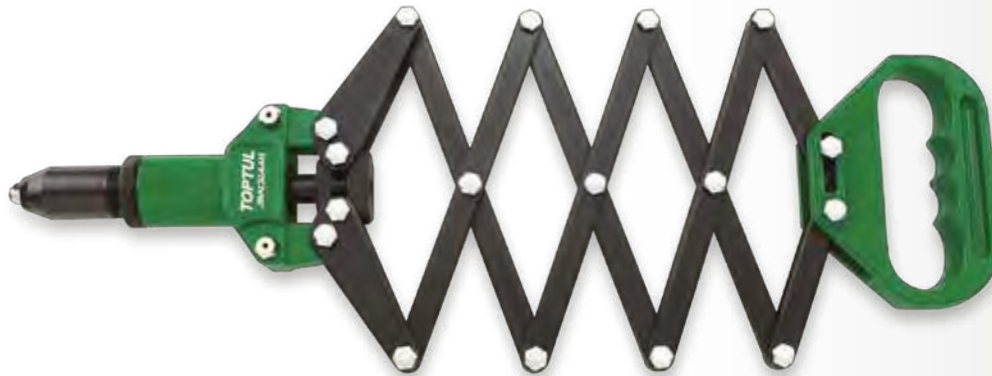

- Rugged all steel construction
- Single pull action for fast repetitive applications
- Stretching design for use in difficult access area
- Suitable for industrial and construction applications
- 4 interchangeable nose pieces: 2.4mm(3/32"), 3.2mm(1/8"), 4.0mm(5/32"), 4.8mm(3/16")
- Extended Length: 310 to 835 mm max.

ITEM NO.	RIVET DIAMETER(mm)		
JBAD2448	2.4(3/32"), 3.2(1/8"), 4.0(5/32"), 4.8(3/16")	1	10

Hand Riveter

- High-leverage chrome molybdenum handles for more power and easier operation
- Precision die-cast aluminum alloy frame constructed with extra hardened steel for longer tool life
- Extended riveter nose design for reaching confined spaces
- Full cushion grips provide optimum comfort in use
- 4 interchangeable nose pieces: 2.4mm(3/32"), 3.2mm(1/8"), 4.0mm(5/32"), 4.8mm(3/16")



ITEM NO.	RIVET DIAMETER(mm)		
JBAA2448	2.4(3/32"), 3.2(1/8"), 4.0(5/32"), 4.8(3/16")	10	40

151PCS

Hand Riveter Set



ITEM NO.	CONTENTS	
GAAD0101	1 JBAA2448 Hand Riveter <hr/> 90 Aluminum Rivets 30PCS- Ø3.2x8mm 30PCS- Ø4x10mm 30PCS- Ø4.8x10mm <hr/> 60 Stainless Rivets 30PCS- Ø4x7mm 30PCS- Ø4.8x10mm	4 (SET)
METAL CASE: W370 x D154 x H50 (mm)		

360° Swivel Head Hand Riveter

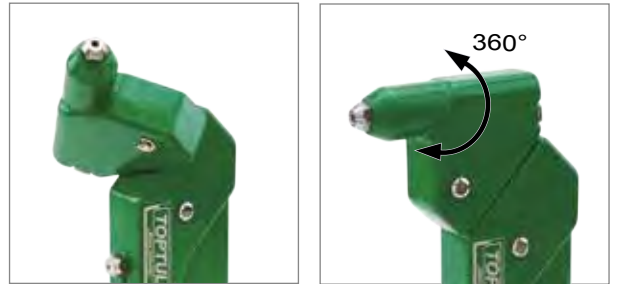

- Rugged all steel construction
- Aluminum alloy steel riveter head
- 360° rotating head for any angle riveting
- Perfect for use in confined spaces
- Spring loaded handle for easy loading
- 4 interchangeable nose pieces: 2.4mm(3/32"), 3.2mm(1/8"), 4.0mm(5/32"), 4.8mm(3/16")

ITEM NO.	RIVET DIAMETER(mm)	L(mm)		
JBAC2448	2.4(3/32"), 3.2(1/8"), 4.0(5/32"), 4.8(3/16")	280	6	24

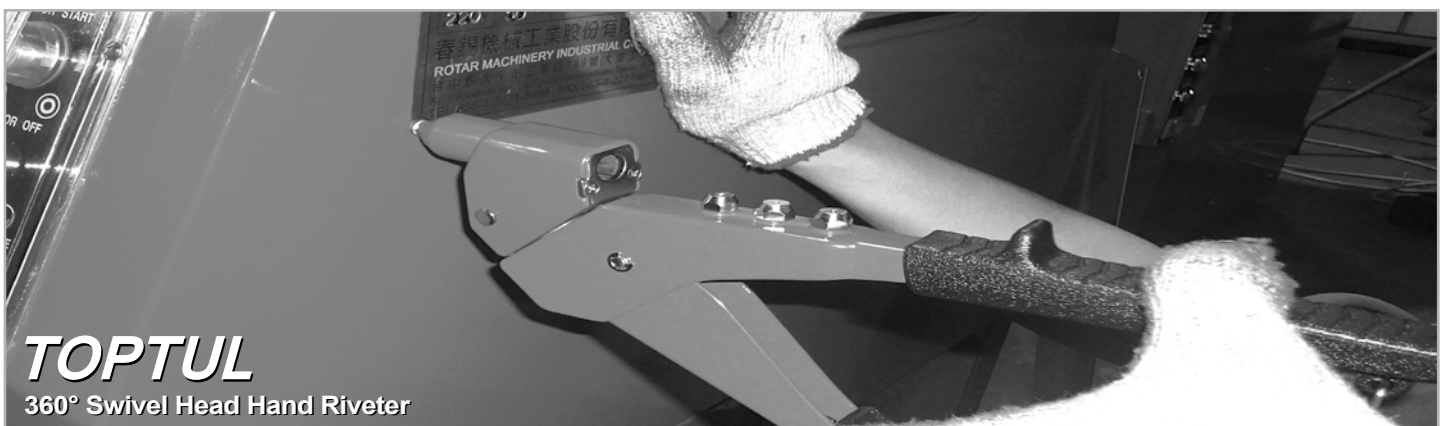
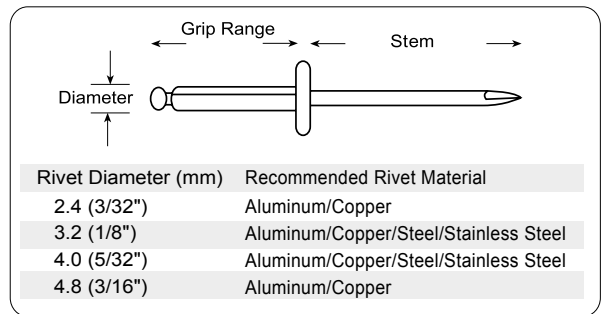

TOPTUL
360° Swivel Head Hand Riveter

Other Tools

■ All Cast Steel Bench Vise



Made of robust cast steel
Duly hardened and knurled jaw
360° swivel base
Equipped with anvil and pipe jaw
Finished with quality wrinkle green paint

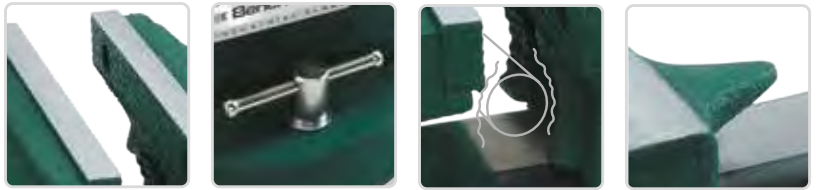

ITEM NO.	SIZE(inch)	JAW OPENING(inch)	THROAT DEPTH(inch)		
DJAC0103	3	3	2	1	1
DJAC0104	4	4	2-1/4	1	1
DJAC0105	5	5	2-5/8	1	1
DJAC0106	6	6	3	1	1
DJAC0108	8	8	3-1/2	1	1
DJAC0110	10	10	4	1	1

■ 2-Jaw Gear Puller (Sliding Arm Type)

Made of Chrome Vanadium Alloy Steel
Sliding-arm universal puller with constantly parallel claws
Puller arms design for confined spaces

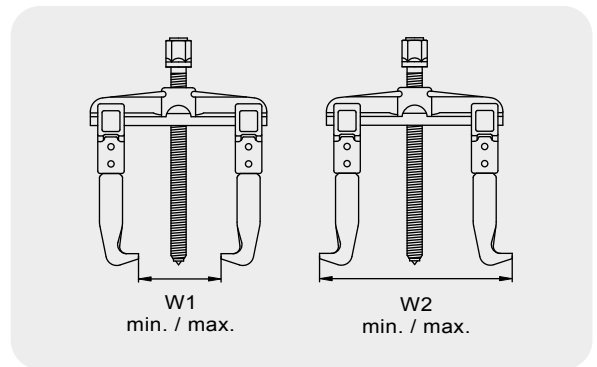



ITEM NO.	SIZE (mm)	Outside Grip Range W1 (min. / max.) mm	Inside Grip Range W2 (min. / max.) mm		
JJAL1208	80	30-80	90-150	1	10
JJAL1212	120	30-120	90-180	1	10
JJAL1216	160	40-160	90-220	1	6
JJAL1220	200	40-200	90-260	1	6

3-Jaw Gear Puller

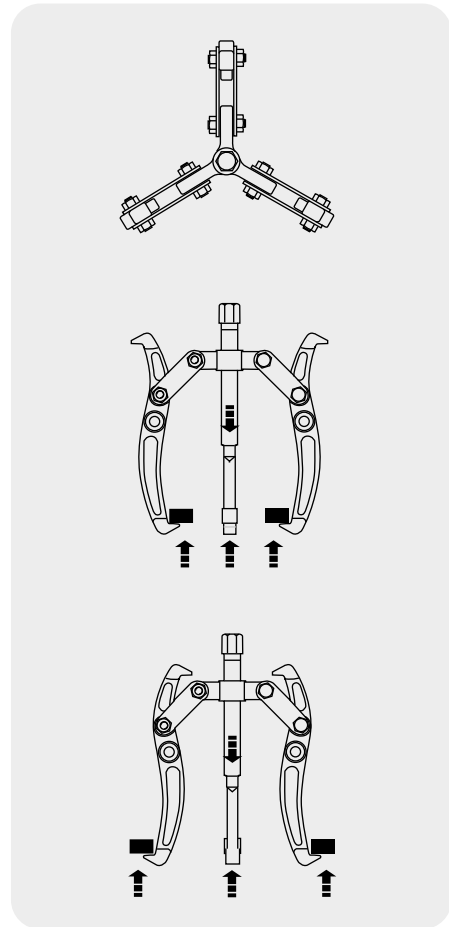
Professional gear puller to remove gears, pulleys and collars from shafts effortlessly and safely. Three-point grip applies a parallel pull. Jaws and arms are forged and machined from quality alloy steel, precision heat treated for maximum durability and strength. Hardened steel center bolt with hex head for sure-grip wrench fit. Jaws can be reversed to grip firmly inside or outside gears or parts.





ITEM NO.	SIZE(inch)		
JJAL0303	3	1	36
JJAL0304	4	1	18
JJAL0306	6	1	8
JJAL0308	8	1	4
JJAL0312	12	1	2

2-Jaw Gear Puller

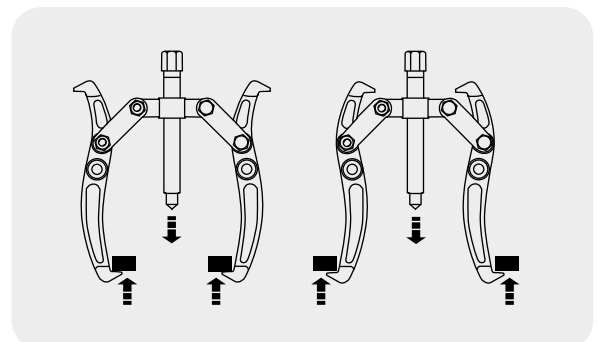
Professional gear puller to remove gears, sprockets, arings and pulleys effortlessly and safely. Jaws and arms are forged and machined from quality alloy steel, precision heat treated for maximum durability and strength. Hardened steel center bolt with hex head for sure-grip wrench fit. Jaws can be reversed to grip firmly inside or outside gears or parts.



ITEM NO.	SIZE(inch)		
JJAL0203	3	1	40
JJAL0204	4	1	32
JJAL0206	6	1	12
JJAL0208	8	1	5
JJAL0212	12	1	2

Other Tools

▣ Lever Type Grease Gun (Variable Stroke)

W/ 6" Rigid Tube & 12" Flexible Hose



- Electric plated finish for long service life
- Short stroke "lever action" for easy use
- Vented head cap for easy filling
- Variable stroke action (2-stage compression)

ITEM NO. CONTENTS  16 (SET)

JGAE0202 1 **JJAA1402**
Lever Type Grease Gun (Variable Stroke)
W/ 6" Rigid Tube
Standard 14oz. Cartridge,
Pressure filler, Bulk 400 c.c.
L=21" (530mm)

1 **JJAC1212**
Flexible Nylon Grease Gun Hose
L=12" (300mm)

■ Flexible Nylon Grease Gun Hose (ITEM NO: JJAC1212)

Rugged 12 inch long nylon flexible hose attaches to grease gun to reach all fittings faster and easier in tight spots and awkward locations.

▣ Flexible Nylon Grease Gun Hose

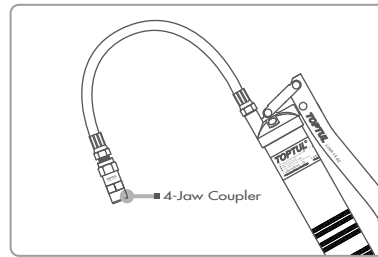

ITEM NO. **JJAC1212**  12

- Rugged 12 inch long flexible hose attaches to grease gun # JJAA1440 to reach all fittings faster and easier in tight spots and awkward locations.

▣ Piston Grip Grease Gun

W/7" Rigid Tube & 12" Flexible Hose



- Electric plated finished for long service life
- Short stroke piston grip action works great in tight spaces
- Two discharge outlets - 90 & 180 °
- Vented head cap for easy filling
- Use standard 14 oz. grease cartridge

ITEM NO. CONTENTS  12 (SET)

JGAE0203 1 **JJBA1402**
Pistol Grip Grease Gun-W/7" Rigid Tube
Standard 14oz. Cartridge
Pressure filler, Bulk 400 c.c.
L=14" (360mm)

1 **JJAC1212**
Flexible Nylon Grease Gun Hose
L=12" (300mm)

▣ Lubrication - Grease Gun

- 4-Jaw Coupler for Better Grip
- Max. Working Pressure: 4,500 PSI (310 BAR)
- Burst Pressure: 10,000 PSI (690 BAR)
- Thread: 1/8 inch x 28PT
- 1 oz. of Grease: per 40 strokes
- Length: Grease Gun W/Rigid Tube and Coupler: 21 inch (530mm)
Flexible Whip Hose - 12 inch (300mm)

ITEM NO. CONTENTS  16 (SET)

JGAE0201 1 **JJAA1440**
Lubrication - Grease Gun
Standard 14 oz. Cartridge
Pressure filler, Bulk 400 c.c. , L=21" (530mm)

1 **JJAC1212**
Flexible Nylon Grease Gun Hose
L=12" (300mm)

Heavy Duty Utility Knife With Spare Blade

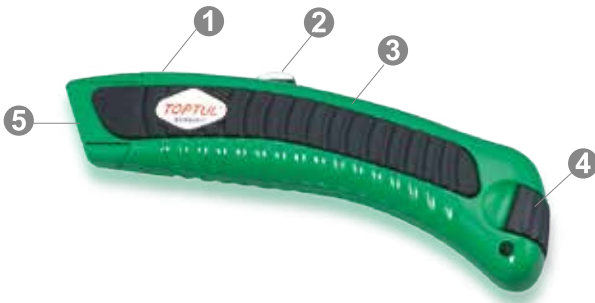

- 1 Curved Handle Design With Slip-Resistant Grip For Comfort And Ease Of Use
- 2 Retractable Blade Locks In 4 Positions
- 3 Unique Comfort Texture For Firm And Strong Grip
- 4 Intergraded Smart Opening Trigger In Design. No Tools Required For Quick Blade Changes
- 5 Safe Overlapping Knife Design Surrounds Blade For Heavy Duty Cutting

ITEM NO.	LENGTH (mm)		
SCAA2017	165	12	72

Utility Knife

(W/Spare Blade)

- Snap-off blades, 8 sharp points snap segment blades
- Premium quality tool steel blade (SK5)
- Stainless steel blade guide for strength and rust resistance
- Rugged ABS housing
- Blade lock knob
- Blade Dimension: W18mm x L100mm (0.5mm thick)



ITEM NO.	LENGTH (mm)		
SCAD1817	165	12	72

Multi-Purpose Hacksaw

- Multi-angle blade adjustment - 45°, 90°, 135° & 180°
- Fully adjustable blade tension
- High blade tension for straight accurate cut (including flush cut)
- Two-hand grip for comfort and easy operation
- Quick and easy blade change
- ABS+TPR plastic ergonomic designed & anti-slip handle
- Shatterproof premium quality blade for excellent cutting performance
- Handy blade storage in tubular frame (stored up to 3pcs spare blade)
- Ideal for cutting metal and aluminum tube, sheets and hard plastics
- Blade: 300mm (12" / 24 TPI), 0.6mm (T)



ITEM NO.	BLADE SIZE (inch)		
SAAA3051	12	12	24

Heavy Duty Hacksaw

- Robust Die Cast Aluminum Frame
- Easy And Smooth Blade Tension Adjustments
- 45° & 90° Blade Cutting Angle
- Shatterproof Premium Quality Blade



Deluxe Mini Hacksaw

- Industrial grade high strength hacksaw
- Premium quality blade
- 6 blade angle settings
- TPR material grip handle

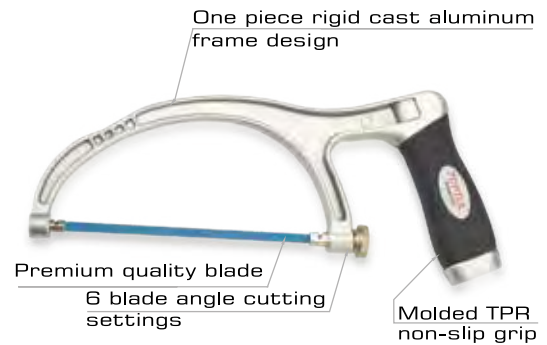

ITEM NO.	BLADE SIZE (inch)		
SAAA3013	12	6	24

ITEM NO.	BLADE SIZE (inch)		
SAAA1527	6	12	72

Other Tools

Multi-Purpose Electricians Scissors



- Specially Designed For Repair Service Use
- Heavy-Duty High Carbon Stainless Steel Mighty Molybdenum And Vanadium Alloy Blades
- Precision Hollow-Ground And Harened Long-Lasting Cutting Edge
- Micro-Serration Blade Design For Strong Grips On Cutting Objects
- Extension Tang Design To Increase Overall Input Leverage
- High Grade Nylon-Made Ergonomic Modern Handles (With 30% Fiberglass)

ITEM NO.	LENGTH (mm)		
SBAA0414	138	8	64

High Tensile Strength Bolt Cutter



HIGH TENSILE STRENGTH BOLT CUTTER

ITEM NO.	CUTTING CAPACITY Ø (mm)	LENGTH (inch)		
SBAB1205	6	12	1	20
SBAB1407	7	14	1	20
SBAB1808	8	18	1	20
SBAB2410	10	24	1	10
SBAB3013	13	30	1	6
SBAB3615	16	36	1	5
SBAB4219	19	42	1	3

Offset Tin Snips



Green - SBAD0224
Right and Straight Cut



Red - SBAD0124
Left and Straight Cut

- Meets or exceeds federal specification ANSI/ASME B107.16-1998 and German standard DIN 6438/11.71
- Drop forged Chrome-Molybdenum Alloy Steel blades
- Induction hardened cutting edges HRC 60-62
- Precision, serrated cutting jaws ensure quality result
- Cuts up to 1.2mm cold rolled steel or 0.7mm AISI-304 stainless steel

Cuts extremely hard metals of hardness of HRC 40 (0.8m/m), such as stainless steel and more.

ITEM NO.	Offset Tin Snips (mm)	Cutting Length (mm)	L (mm)		
SBAD0124	Left cut	35	240	6	48
SBAD0224	Right cut	35	240	6	48

Aviation Tin Snips



Green - SBAC0225
Right Cut



Yellow - SBAC0325
Straight cut



Red - SBAC0125
Left Cut

- Meets or exceeds federal specification ANSI/ASME B107.16-1998 and German standard DIN 6438/11.71
- Drop forged Chrome-Molybdenum Alloy Steel blades
- Induction hardened cutting edges HRC 60-62
- Precision, serrated cutting jaws ensure quality result
- Cuts up to 1.2mm cold rolled steel or 0.7mm AISI-304 stainless steel

Cuts extremely hard metals of hardness of HRC 40 (0.6m/m), such as stainless steel and more.

ITEM NO.	Aviation Tin Snips (mm)	Cutting Length (mm)	L (mm)		
SBAC0125	Left cut	35	248	6	48
SBAC0225	Right cut	35	248	6	48
SBAC0325	Straight cut	35	250	6	48

130PCS

Professional Threaded Coil-Insert Repair Kit

- Ideal for repairing and restoring damaged threads, suitable for machine construction, engine repair and other automotive applications
- For most commonly used metric bolt sizes
- Thread insert sizes M5, M6, M8, M10 and M12
- Each size includes stainless steel screw coils, high speed steel thread tap & twist drill, installation tools and pin breaking tools



1. Drill out damaged thread using correctly sized drill bit



2. Tap re-drilled hole using tap



3. Load coiled insert into applicator



4. Screw coil into casting



5. Using pin breaking tool, break off pin on insert



6. Thread is repaired and ready to use

ITEM NO.	CONTENTS	8 (SET)
JGAD130A	<p>110 Stainless Steel Screw Coil Inserts</p> <p>25PCS- M5x0.8mmx1.5D (L=7.5mm)</p> <p>25PCS- M6x1.0mmx1.5D (L=9.0mm)</p> <p>25PCS- M8x1.25mmx1.5D (L=12.0mm)</p> <p>25PCS- M10x1.5mmx1.5D (L=15.0mm)</p> <p>10PCS- M12x1.75mmx1.5D (L=18.0mm)</p> <p>5 Twist Drills</p> <p>M5(Ø5.2mm), M6(Ø6.3mm), M8(Ø8.3mm), M10(Ø10.4mm), M12(Ø12.4mm)</p> <p>5 Thread Taps</p> <p>M5x0.8mm, M6x1.0mm, M8x1.25mm, M10x1.5mm, M12x1.75mm</p> <p>Installation Tools</p> <p>5 M5, M6, M8, M10, M12</p> <p>Pin Breaking Tools</p> <p>5 M5, M6, M8, M10, M12</p>	
METAL CASE: W357 x D221 x H28 (mm)		

5PCS

Screw Extractor Set

CR-MO



ITEM NO.	CONTENTS	25 (SET)
JGAW0502	5 7/64", 9/64", 5/32", 1/4", 19/64"	

5PCS

Screw Extractor Set

CR-MO



ITEM NO.	CONTENTS	25 (SET)
JGAW0501	5 1/8", 1/4", 5/16", 7/16", 9/16"	

40PCS

Tap & Die Set



ITEM NO.	CONTENTS	10 (SET)
JGAI4001	<p>34 Tap & Die</p> <p>M3x0.5, M3x0.6, M4x0.7, M4x0.75, M5x0.8, M5x0.9, M6x0.75, M6x1.0, M7x0.75, M7x1.0, M8x1.0, M8x1.25, M10x1.25, M10x1.5, M12x1.25, M12x1.5, 1/8 NPT-27</p> <p>1 Die Stock Handle</p> <p>1" / 25mm O.D.</p> <p>1 Tap Wrench</p> <p>M3-M12</p> <p>1 T-Type Tap Wrench</p> <p>M3-M6</p> <p>1 Screw Pitch Gauge</p> <p>0.5, 0.6, 0.7, 0.75, 0.8, 0.9, 1.0, 1.25, 1.5, 1.75, 27, 28</p> <p>1 Slotted Screwdriver</p> <p>0.6x3mm L=93mm</p> <p>1 Blow Case</p> <p>W300xD230xH53mm</p>	
BLOW CASE: W300 x D230 x H53 (mm)		

Other Tools

6PCS

1/2" DR. Impact Driver Set



ITEM NO.	CONTENTS	20 (SET)
GAAD0602	1 FIAA1615 1/2" Dr. Impact Driver - 145mm (L) 1 FTAB1610 Quick Change Bit Holder 1/2" Dr. x 5/16" (H) - 38mm (L) 2 FSAC1008 & 1010 5/16" Hex Shank Slotted Insert Bits 1.2x8 mm & 1.6x10 mm - 36mm (L) 2 FSBC1002 & 1003 5/16" Hex Shank Phillips Insert Bits PH2 & PH3 - 36mm (L)	

METAL CASE: W196 x D70 x H47 (mm)

8PCS

1/2" DR. Impact Driver Set



ITEM NO.	CONTENTS	20 (SET)
GAAD0808	1 FIAA1615 1/2" Dr. Impact Driver - 145mm (L) 1 FTAB1610 Quick Change Bit Holder 1/2" Dr. x 5/16" (H) - 38mm (L) 2 FSAC1008 & 1010 5/16" Hex Shank Slotted Insert Bits 1.2x8 mm & 1.6x10 mm - 36mm (L) 2 FSBC1002 & 1003 5/16" Hex Shank Phillips Insert Bits PH2 & PH3 - 36mm (L) 2 FSBD1002 & 1003 5/16" Hex Shank Phillips Insert Bits PH2 & PH3 - 80mm (L)	

METAL CASE: W196 x D70 x H47 (mm)

Telescoping Magnetic Pick-Up Tool



Extends From 130-640mm Long
Telescoping Shaft Lifting Capacity 3.5 LBS

ITEM NO.	MAGNET(lbs)	LENGTH(mm)	24	384
JJAG3E63	3.5 (1.6kgs)	130-640		

Magnetic Flexible Handle

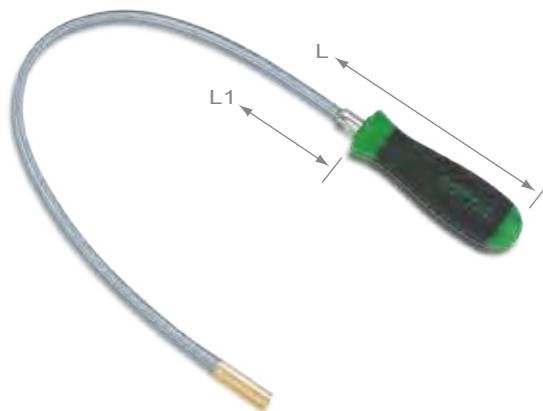

Flexible shaft holds shape and can retrieve at hard-to-reach angles and around obstructions

ITEM NO.	L1(mm)	L(mm)	10	60
JJAD0512	305 (12")	420 (16-1/2")		
JJAD0518	457 (18")	572 (22-1/2")		

Magnetic Flexible Handle

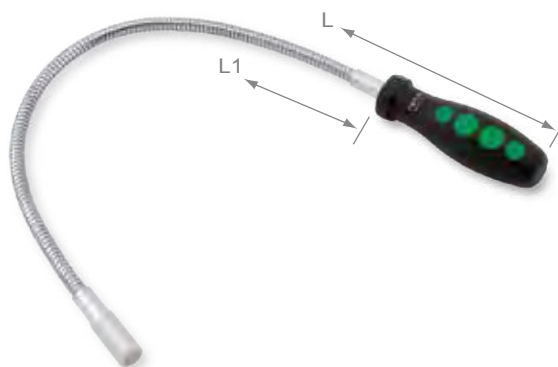

• Strong shaft bends and holds in all position
• Magnetic capacity: 1.6kgs (3.5lbs)

ITEM NO.	L1(mm)	L(mm)	12	48
JJAD1423	475 (19")	585		

Magnetic Trays



ITEM NO.	SIZE(mm)	1	30
JJAF1506	Ø150 x H42		
JJAF2414	L240 x W140 x H42		

Stainless Steel Vernier Caliper

- Made of fully hardened stainless steel
- Accuracy ±0.02 mm
- Graduations: 0.02 mm / 0.001 inch
- Measuring bar in both metric and imperial measurement
- Easy to read clear black engraved graduations
- For inside, outside, step and depth measurements
- Lock screw for sliding jaw
- Supplied in plastic case

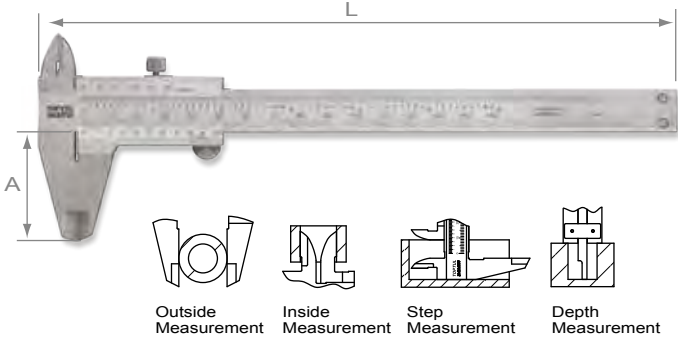

ITEM NO.	Measuring Range (mm)	A (mm)	L (mm)	
IACA0150	0 - 150	40	235	1

Measuring Tape



- Easy Access, Sliding Thumb Lock
- Nylon Coated Steel Tape for Maximum Corrosion Protection & Wear Resistance
- High Impact ABS Case with Rubber Protected
- Double Riveted End Hook for Lasting Durability
- Stop Button and Automatic Tape Rewind
- Shock-Absorbing Blade Return Bumper
- Dual Scale Reading in both Metric and Imperial

ITEM NO.	SIZE	TAPE WIDTH(inch)		
IAAA0003	3M/10FT	3/4"(19mm)	6	72
IAAA0005	5M/16FT	3/4"(19mm)	12	72

Angel Nozzle Air Blow Gun

- Ideal for cleaning and removing swarf or dust during assembly
- Angled nozzle enable to reach into tight places
- Steel nozzle with non-slip handle
- Working Pressure: 70 - 120 PSI / 5.0 - 8.0 kgs
- Max Pressure: 160 PSI / 11 kgs
- Sound Pressure: 85 - 90 dB
- Air Consumption (90 PSI): 1/4" Hose - 9 CFM (250 l/min)



ITEM NO.	INLET(inch)	TUBE LENGTH(inch)		
KAGA0204	1/4	4	30	60
KAGA0210	1/4	10	25	50

20PCS

Metric Feeler Gauge (Tapered Tips)

- 20 Blades made of hardened Spring Steel
- Thumb notch design of blade protector to aid in removal of blades
- Chrome plated steel protector with locking knurl nut



• CONTENTS

- 0.05, 0.10, 0.15, 0.20, 0.25, 0.30, 0.35, 0.40, 0.45, 0.50, 0.55, 0.60, 0.65, 0.70, 0.75, 0.80, 0.85, 0.90, 0.95, 1.00mm

ITEM NO.	Number of Blades	Blade Length	Blade Width	Blade Thickness Range		
ICAA0020	20	100mm	10mm	0.05 - 1.00mm	50	200

Measuring Tape



- Easy Access, Sliding Thumb Lock
- High Impact Stainless Steel Case With Nylon Protected
- Double Riveted End Hook For Lasting Durability
- Shock-Absorbing Blade Return Bumper

ITEM NO.	SIZE	TAPE WIDTH(inch)		
IAAB1905	5M/16FT	3/4"(19mm)	12	72
IAAB2510	10M/33FT	1"(25mm)	12	36

4PCS

Tweezers Set



ITEM NO.	
JGAA0401	20 (SET)

Other Tools

Jumbo Pry Bar

- Used for all large prying, levering and positioning heavy duty applications
- Made of square chrome molybdenum alloy steel
- High impact go-through shank with steel cap
- Hardened and sharpened blade tips
- Extra large bi-component plastic PP+TPR material grip handle

CR-MO



ITEM NO.	TYPE	L(inch)		
JCCC2025	90 Degree Angle Tip Pry Bar (wide face)	25	2	8
JCCB2025	75 Degree Angle Tip Pry Bar (narrow face)	25	2	8
JCCD2036	Straight Pry Bar (wide face)	36	3	6
JCCA2036	30 Degree Angle Tip Pry Bar (wide face)	36	3	6

Pry Bar

- Made of Chrome Vanadium Steel
- Flat and beveled tips allow application in areas with restricted access
- Solid square blades guarantee high power transmission

CR-V



Black Phosphate Finish

ITEM NO.	SIZE(inch)		
JCBA0608	8	5	80
JCBA9E12	12	5	30
JCBA1118	18	5	20
JCBA1124	24	5	10

4PCS

Jumbo Pry Bar Set



ITEM NO. CONTENTS 2 (SET)

- JGAI0401** 1 **JCCD2036**
Straight Pry Bar - 36" (L)
- 1 **JCCA2036**
30 Degree Angle Tip Pry Bar - 36" (L)
- 1 **JCCB2025**
75 Degree Angle Tip Pry Bar - 25" (L)
- 1 **JCCC2025**
90 Degree Angle Tip Pry Bar - 25" (L)

BLOW CASE: W1000 x D255 x H75 (mm)

4PCS

Mechanic Pry Bar Set

CR-V



Black Phosphate Finish

ITEM NO.	CONTENTS		
JGAT0402	4 8", 12", 18", 24"	8	(SET)



File Tool



ITEM NO.	TYPE	L(inch)		
SDBC0821	Half Round File	8	5	60
SDBA0808	Square File	8	5	60
SDBD0808	Round File	8	5	60
SDBB0821	Flat File	8	5	60
SDBE0815	Triangle File	8	5	60

4PCS

File Set



ITEM NO.	CONTENTS		(SET)
GBAR0401	4 Square File - 8", Flat File - 8" Half Round File - 8", Round File - 8"	5	(SET)

5PCS

File Set



ITEM NO.	CONTENTS		(SET)
GPAQ0503	1 SDBC0821 Half Round File - 8" 1 SDBA0808 Square File - 8" 1 SDBD0808 Round File - 8" 1 SDBB0821 Flat File - 8" 1 SDBE0815 Triangle File - 8"	6	(SET)

6PCS

Needle File Set

- High quality precision machined needle files
- Suitable for fine abrasion, profile cutting and finishing of common workshop materials
- 4mm diameter, overall length 160mm with 75mm of cutting surface



ITEM NO.	CONTENTS		(SET)
GNBA0601	1 SDNA0401 Knife Needle File 1 SDNA0402 Round Needle File 1 SDNA0403 Half Round Needle File 1 SDNA0404 Square Needle File 1 SDNA0405 Triangle Needle File 1 SDNA0406 Flat Needle File	25	(SET)

5PCS

Diamond Needle File Set

- High quality precision machined diamond needle files
- Perfect for filing off sharp edges, reshaping cuts or reaming drilled holes
- 4mm diameter, overall length 160mm with 65mm of #150 grit diamond coating surface



ITEM NO.	CONTENTS		(SET)
GNBA0501	1 SDNB0402 Round Diamond Needle File 1 SDNB0403 Half Round Diamond Needle File 1 SDNB0404 Square Diamond Needle File 1 SDNB0405 Triangle Diamond File 1 SDNB0406 Flat Diamond Needle File	25	(SET)

TOPTUL
FILE SET SERIES

Special Collections



TOPTUL SUMMER POLO SHIRT
AXG00011704: Large
AXG00011705: X-Large
AXG00011706: XX-Large



TOPTUL SUMMER POLO SHIRT (All Black)
AXG00011404: Large
AXG00011405: X-Large



TOPTUL WINTER SHIRT
AXG00012004: Large
AXG00012005: X-Large



TOPTUL VEST
AXG00010602: Medium
AXG00010603: Large
AXG00010604: X-Large
AXG00010605: XX-Large
AXG00010606: XXX-Large



AXG00008903



AXG00008901



AXG00008902



TOPTUL STAINLESS STEEL VACUUM CUP
AXG00018001



TOPTUL TRAVELLING BAG
AXG00014001
(470 x 260 x 240 mm)



TOPTUL WORK GLOVES
AXG00020001: Small
AXG00020002: Medium
AXG00020003: Large
AXG00020004: X-Large



- Quick dry
- Effectively dissipates heat away from skin



- Non-slip design on palm and fingers to provide comfort-grip



Vitrage automobile

REPLACEMENT & RÉPARATION





☞ **Couteau à main pour pare-brise**
130 mm • REF : **PPP-WST31A**
☞ **Manche pour couteau à main PPP-WST31A**
REF : **PPP-WST31AH**



☞ **Couteau à main pour pare-brise**
120 mm renforcé
REF : **PS-31A-C**



☞ **Couteau à main ajustable à levier**
(E 27 mm x l 40 mm x L 137 mm)
REF : **PPP-WST31Z**



☞ **Couteau à froid ajustable**
(E 22 mm x l 32 mm x L 137 mm)
REF : **PPP-WST31ZT**



☞ **Manche pour couteau PPP-WST31Z/ZT**
120 mm renforcé
REF : **PPP-WST31Z-PH**



☞ **Lame pour couteau à main**
25 mm déportée. Vendue à l'unité
REF : **PPP-WST31CZ**



☞ **Lame de couteau à main avec protection TEFLON**
19 mm. Vendue à l'unité • REF : **PPP-WST31BTTC**
25 mm. Vendue à l'unité • REF : **PPP-WST31CTTC**
37 mm. Vendue à l'unité • REF : **PPP-WST31DTTC**



☞ **Lame de couteau à main dentelée**
19 mm dentelée. Vendue à l'unité • REF : **PPP-WST31BD**
25 mm dentelée. Vendue à l'unité • REF : **PPP-WST31CD**
37 mm dentelée. Vendue à l'unité • REF : **PPP-WST31DD**



☞ **Lame de couteau à main**
19 mm. Vendue à l'unité • REF : **PPP-WST31B**
25 mm. Vendue à l'unité • REF : **PPP-WST31C**
37 mm. Vendue à l'unité • REF : **PPP-WST31D**



☞ **Lame de couteau à main extra fine**
19 mm. Vendue à l'unité • REF : **PPP-WST31BT**
25 mm. Vendue à l'unité • REF : **PPP-WST31CT**
37 mm. Vendue à l'unité • REF : **PPP-WST31DT**



☞ **Lame de couteau à main Stainless**
19 mm STAINLESS. Vendue à l'unité • REF : **PPP-WST31BS**
25 mm STAINLESS. Vendue à l'unité • REF : **PPP-WST31CS**
37 mm STAINLESS. Vendue à l'unité • REF : **PPP-WST31DS**



☞ **Lame de couteau à main inversée**
Etudiée pour les vitrages encapsulés, son affûtage éloigne la lame du vitrage. Vendue à l'unité.
19 mm • REF : **PPP-WST31BR**
25 mm • REF : **PPP-WST31CR**
37 mm • REF : **PPP-WST31DR**



⊕ **Pierre d'affûtage en diamant**
REF : PPP-WST31DSH



⊕ **5 pastilles protège carrosserie pour lame couteau à froid**
REF : PPP-WST62PC



⊕ **Couteau pneumatique**
REF : PPP-WST45
⊕ **Kit couteau pneumatique + 6 lames**
REF : PPP-WST45SN



⊕ **Couteau électrique FEIN 220V**
REF : PPP-WST451



⊕ **Couteau électrique FEIN 220V**
Système Quick In*. Moteur 450 W
REF : PPP-WST451-A1.7

*changement rapide des lames



⊕ **Coupe buse en V crantée (noire)**
REF : PPP-WST81
⊕ **Coupe buse métal en V**
REF : PPP-WST81A



⊕ **Lame en L dentelée 19 mm**
D'autres modèles sur demande.
Vendue à l'unité
REF : PPP-WST45V19

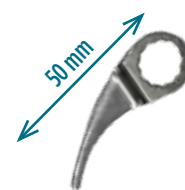

⊕ **Lame contre-coudée 50 mm**
D'autres modèles sur demande.
Vendue à l'unité
REF : PPP-WST45D



⊕ **Lame contre-coudée 57 mm**
D'autres modèles sur demande.
Vendue à l'unité
REF : PPP-WST45F

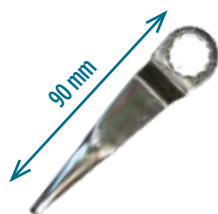

⊕ **Lame contre-coudée 90 mm**
D'autres modèles sur demande.
Vendue à l'unité
REF : PPP-WST45G

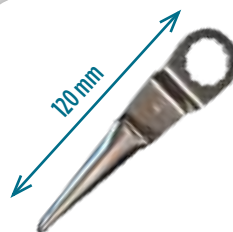

⊕ **Lame contre-coudée dentelée 120 mm**
D'autres modèles sur demande.
Vendue à l'unité
REF : PPP-WST45X



⊕ **Lame en U 95 mm**
D'autres modèles sur demande.
Vendue à l'unité
REF : PPP-WST45K

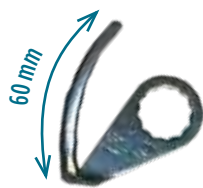

⊕ **Lame en U 60 mm**
D'autres modèles sur demande.
Vendue à l'unité
REF : PPP-WST45T



⊕ **Lame en U 38 mm dentelée**
D'autres modèles sur demande.
Vendue à l'unité
REF : PPP-WST45ID



⊕ **Lame en U 24 mm**
D'autres modèles sur demande.
Vendue à l'unité
REF : PPP-WST45L



⊕ **Lame en U 36 mm**
D'autres modèles sur demande.
Vendue à l'unité
REF : PPP-WST45J

➔ WK1 - Lame plate longue

(300 mm) • REF : **PPB-WK1**



(370 mm) • REF : **PPB-WK1X**



(300 mm) dentelée • REF : **PPB-WK1-S**



(370 mm) • REF : **PPB-WK1ZX**



➔ WK2 - Lame plate universelle

(240 mm) • REF : **PPB-WK2**



(240 mm) dentelée • REF : **PPB-WK2VS**



(240 mm) dentelée • REF : **PPB-WK2S**



➔ WK3 - Lame multifonction coudée

(190 mm) • REF : **PPB-WK3**



(190 mm) dentelée • REF : **PPB-WK3S**



➔ WK4 - Lame multifonction contre-coudée

(190 mm) • REF : **PPB-WK4**



(140 mm) dentelée • REF : **PPB-WK4ZRS**



(190 mm) dentelée • REF : **PPB-WK4RS**



(140 mm) dentelée • REF : **PPB-WK4ZS**



(190 mm) dentelée • REF : **PPB-WK4S**



(140 mm) dentelée • REF : **PPB-WK4ZVRS**



(140 mm) • REF : **PPB-WK4Z**



(140 mm) dentelée • REF : **PPB-WK4ZVS**



➔ WK5 - Lame plate

(130 mm) • REF : **PPB-WK5**



(130 mm) dentelée • REF : **PPB-WK5S**



➔ WK6 - Lame à agrafer

(125 mm) - largeur 15 mm
• REF : **PPB-WK6-15**



largeur 25 mm • REF : **PPB-WK6-M**



(125 mm) - largeur 25 mm
• REF : **PPB-WK6-25**



largeur 20 mm • REF : **PPB-WK6-S**



(125 mm) - largeur 40 mm
• REF : **PPB-WK6-40**



WK6L, M, S & 40 • REF : **PPB-WK6SET**



largeur 30 mm • REF : **PPB-WK6-L**



➔ WK17 - Lame en U

Enlève le polyuréthane entre la baie et la vitre ou entre les 2 vitres - idéale pour les bus, les trains et les bateaux. U de 6 mm
• REF : **PPB-WK17-6**

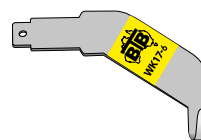

➔ WK18 - Lame contre-coudée plate

(140 mm) • REF : **PPB-WK18Z**



(140 mm) dentelée • REF : **PPB-WK18ZS**



➔ WK19 - Lame contre-coudée plate

(180 mm) • REF : **PPB-WK19Z**



(180 mm) dentelée • REF : **PPB-WK19ZS**



➔ WK24 - Lame coudée

(240 mm) • REF : **PPB-WK24**



(150 mm) dentelée • REF : **PPB-WK24ZS**



(240 mm) dentelée • REF : **PPB-WK24RS**



(150 mm) • REF : **PPB-WK24ZV**



(240 mm) dentelée • REF : **PPB-WK24S**



(150 mm) dentelée • REF : **PPB-WK24ZVRS**



(150 mm) • REF : **PPB-WK24Z**



(150 mm) dentelée • REF : **PPB-WK24ZVS**



(150 mm) dentelée • REF : **PPB-WK24ZRS**



➔ WK27 - Lame gauche

largeur 30 mm • REF : **PPB-WK27L**



largeur 19 mm • REF : **PPB-WK27S**

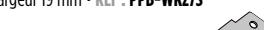

largeur 25 mm • REF : **PPB-WK27M**



largeur 40 mm • REF : **PPB-WK27XL**



largeur 25 mm • REF : **PPB-WK27RM**



➔ WK28 - Lame droite

largeur 30 mm • REF : **PPB-WK28L**



largeur 19 mm • REF : **PPB-WK28S**



largeur 25 mm • REF : **PPB-WK28M**



largeur 40 mm • REF : **PPB-WK28XL**

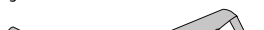

largeur 25 mm • REF : **PPB-WK28RM**





↳ Accessoires



↳ Manche simple pour lame BTB
REF : PPB-WK7



↳ Manche double pour lame BTB
REF : PPB-WK7L



↳ Pierre d'affûtage
REF : PPB-WK8DSM



↳ Pulvérisateur 280 ml
REF : PPB-WK9



↳ Bande velcro pour protéger la carrosserie
REF : PPB-WK11VEL



↳ Embout de contrôle de l'outil
REF : PPB-WK10CC



↳ Outil pneumatique BTB
REF : PPB-WK10HD

↳ Guides



↳ Pour lames jaunes en Z WK3 WK4
REF : PPB-WK11AW

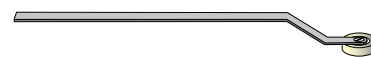

↳ Pour lames jaunes en Z WK3 WK4
REF : PPB-WK11BW5



↳ Pour lames orange
REF : PPB-WK11CW



↳ Pour lames WK5, WK5S & WK2S
REF : PPB-WK11DW5



↳ Pour lames WK1 & WK1S
REF : PPB-WK11EW

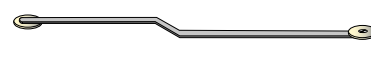

↳ Pour lames WK2, WK2S, WK24, WK24S, WK3 & WK4
REF : PPB-WK11FW

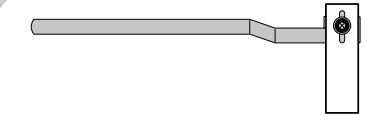

↳ Pour lames WK27 & WK28
REF : PPB-WK11PW

↳ Partenaire exclusif BTB pour la France

N'hésitez pas à nous contacter pour tout conseil technique et besoin de formation. Nos kits sont livrés avec 4 lames, permettant la découpe du cordon par l'extérieur ou l'intérieur du véhicule.



Voir la vidéo sur www.panther-pro.fr



↳ Kit couteau pneumatique BTB 4 lames
REF : PPB-STR4



↳ Kit couteau électrique BTB 4 lames (batterie)
REF : PPB-STR4-E



⊕ Lame Equalizer

100 mm • REF : PPP-EQ-EEB793
200 mm • REF : PPP-EQ-EEB795
300 mm • REF : PPP-EQ-EEB797



⊕ Fourreau Equalizer

100 mm • REF : PPP-EQ-EES804
200 mm • REF : PPP-EQ-EES808
300 mm • REF : PPP-EQ-EES812

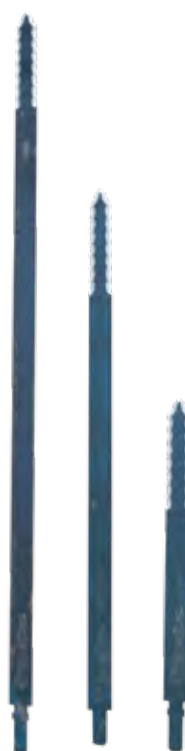

⊕ Lame Equalizer dentelée

100 mm • REF : PPP-EQ-ESB1304
200 mm • REF : PPP-EQ-ESB1308
300 mm • REF : PPP-EQ-ESB1312



⊕ Couteau pneumatique Excilibur - Kit complet

REF : PPP-EQ-AEB405

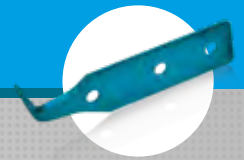

☞ Système de découpe Panther-Cut Pro pour pare-brise par corde à piano

Notre système permet la découpe de tout vitrage, pare-brise, lunette, custode.

De par sa conception :

- Vous pouvez déposer les vitres encapsulées sans endommager le joint.
- Vous réduisez le risque de toucher la baie et les différentes garnitures.
- Vous pouvez réutiliser la corde.

REF : PPP-WST100



Voir la vidéo sur
www.panther-pro.fr



☞ Système de découpe RL-EEZ pour pare-brise

Système permettant la découpe de tout vitrage avec un seul opérateur et sans forcer grâce à sa télécommande et son moteur électrique 12 V ; pare-brise, lunette, custode : vous pouvez déposer les vitres encapsulées sans endommager le joint. Vous réduisez le risque de toucher la baie et les différentes garnitures. S'utilise uniquement avec la corde nylon PPD-381052

REF : PPD-380012N



☞ Corde à piano nylon 100 m

REF : PPP-WST27K1



⊕ **Outil de découpe à ressort pour corde à piano**

Permet de découper le cordon de colle seul
REF : PPP-WST381



⊕ **2 poignées aluminium pour corde à piano**

REF : PS-27-P



⊕ **2 poignées pour corde à piano**

REF : PPP-WST77

⊕ **Corde à piano tressée + 2 poignées**

REF : PPP-WST78N

⊕ **Corde à piano carrée + 2 poignées**

REF : PPP-WST781N



⊕ **Outil corde à piano (type T) avec trou**

Pour le passage de la corde permettant de la tirer de l'extérieur vers l'intérieur
REF : PPP-WST19TH



⊕ **Outil long manche pour corde à piano**

REF : PPP-WST33



⊕ **Kit outil corde à piano (manche + poignée)**

REF : PPP-WST34N



⊕ **Outil passe corde à piano avec trou**

Pour le passage de la corde permettant de la tirer de l'extérieur vers l'intérieur
REF : PPP-WST19H



⊕ **Outil passe corde à piano (type aiguille)**

REF : PPP-WST19A



⊕ **Outil passe corde à piano renforcé**

REF : PS-WF



⊕ **Corde à piano tressée 22 m**

REF : PPP-WST77C



⊕ **Corde nylon kevlar 200 nm en 1,05 mm**

Corde nylon kevlar haute résistance
REF : PPD-381052



⊕ **Corde à piano triangulaire 0,7 mm x 50 m**

REF : PPP-WST77T



⊕ **Corde à piano carrée 65 m**

La corde carrée la plus résistante du marché
REF : PPP-WST27DS1B



⊕ **Corde à piano carrée 0,6 mm x 22 m**

REF : PPP-WST27D



⊕ **Corde à piano carrée extra cut 0,7 mm x 23 m**

REF : PPP-WST27DS



⊕ **Pistolet pour cartouche 310 ml batterie Li-ion (18V)**

REF : PPP-MIL310/18V



⊕ **Pistolet pour poche 400 ml batterie Li-ion (18V)**

REF : PPP-MIL400/18V



⊕ **Pistolet pour poche 600 ml batterie Li-ion (18V)**

REF : PPP-MIL600/18V



⊕ **Tube transparent 600 ml**

Pour PPP-MIL600/18V • REF : PPP-MIL600/TT

⊕ **Tube transparent 400 ml**

Pour PPP-MIL400/18V • REF : PPP-MIL400TT



⊕ **Chargeur pour pistolet Milwaukee 18V**

REF : PPP-MILCHARG18V



⊕ **Batterie 1,5 Ah pour pistolet Milwaukee 18V**

REF : PPP-MILBAT18V



Panther Pro

OUTILLAGE POUR LES PROFESSIONNELS

revendeur
de la marque



⊕ Pistolet air comprimé pour cartouche 310 ml
REF : PP-AT-310CG



⊕ Pistolet air comprimé pour poche 400 ml
REF : PP-AT-400CG



⊕ Pistolet Milwaukee tube alu 12 V, 310 ml / 400 ml
REF : PPP-MIL400/12V



⊕ Poussoir pour pistolet à poche
Compatible MILWAUKEE 14,4 V 400 ml / 600 ml,
PPP-PTCCG7.22B, PP-AT-400CG, et tout pistolet manuel
REF : PPP-MIL400/P



⊕ Poussoir pour pistolet à poche
Compatible PPP-MIL400/18V, PPP-MIL600/18V,
PPP-MIL400/12V
REF : PPP-MIL400/P3



⊕ Ecrou plastique de fermeture de tube pour pistolet
REF : PNS-BG-ELR



⊕ Visseuse compacte 12 V C12D livrée avec
1 chargeur et 2 batteries
REF : PPP-MILC12D
⊕ Mandrin pour PPP-MILC12D
REF : PPP-MILMANDRIN



⊕ Pompe à mastic pour poche 400 ml / cartouche
310 ml
REF : PNS-WT-250L



⊕ Pompe à mastic pour poche 600 ml
REF : PNS-WT-250XL



⊕ Pompe à mastic squelette
REF : PNS-WT-214L



⊕ Pompe à mastic
REF : PNS-WT-215IH



⊕ Pompe à mastic
REF : PNS-WT-240L



Demandez nos fiches techniques



⊕ **Colle Dow Epoxy 2090**
198 ml - Colle structurelle bi-composant (pour pièces de carrosserie)
REF : PP-PUDOWBETAMATE



TEMPS DE LIBÉRATION : 1/2 HEURE

⊕ **Colle Dow 1580 (berlingot)**
420 ml - Temps de libération 1/2 heure
REF : PP-PUDOW2



TEMPS DE LIBÉRATION : 1 HEURE

⊕ **Colle Dow 1527 (berlingot)**
400 ml - Temps de libération 1 heure
REF : PP-PUDOW1



TEMPS DE LIBÉRATION : 2 HEURES

⊕ **Colle Dow 1507 (berlingot)**
400 ml - Temps de libération 2 heures
REF : PP-PUDOW5



TEMPS DE LIBÉRATION : 2 HEURES

⊕ **Colle Dow 1590CT (berlingot)**
600 ml - Spécial charge lourde - Bus / PL - Supporte les UV - Idéale pour les lissages - Temps de libération 2 heures
REF : PP-PUDOW3



⊕ **Primaire 5504G verre / tôle**
125 ml • REF : PP-PRDOW
250 ml • REF : PP-PRDOW2
10 ml • REF : PP-PRDOW1



⊕ **Easy Sponge**
Enlève le silicone
REF : PP-DOWSPONGE



⊕ **Betaclean Lingette**
8 ml • REF : PP-DOWCLEAN



⊕ **Betaclean pulvérisateur**
500 ml • REF : PP-DOWCLEAN1
⊕ **Betaclean bidon**
25 l • REF : PP-DOWCLEAN2



Demandez nos fiches techniques.
Pour tout autre produit Sika,
nous consulter.



TEMPS DE LIBÉRATION : 1 HEURE

Colle Sika Tack Drive 400 ml

Nous consulter pour plus d'informations.
Temps de libération 1 heure
REF : PP-PUSK3 ☎



TEMPS DE LIBÉRATION : 2 HEURES

Sika Tack Go

Temps de libération 2 heures
310 ml • REF : PP-PUSK ☎
400 ml • REF : PP-PUSK1 ☎



TEMPS DE LIBÉRATION : 2 HEURES

Colle Sika Tack MOVE Transportation 600 ml

Elaborée spécialement pour les gros vitrages bus/PL, cette colle supporte les UV et est parfaite pour faire les lissages. Nous consulter pour plus d'informations - Temps de libération 2 heures
REF : PP-PUSK5 ☎



Sikaflex 222 UV 310 ml

Colle PU résistante aux ultraviolets, utilisée pour les joints de finition
REF : PP-PUZ20UV ☎



Primaire Sika 206 G + P 250 ml

REF : PP-PUPR ☎



Sika Activator Pro 250 ml

REF : PP-PUAC ☎

Sika Activator Pro 1000 ml

REF : PP-PUAC2 ☎



Sika primaire 207

30 ml • REF : PP-PUPR7 ☎

100 ml • REF : PP-PUPR7-1 ☎

250 ml • REF : PP-PUPR7-2 ☎



Sika Power Clean Aid

Par boîte de 168 éponges - Permet de dépolluer la sérigraphie du vitrage.
REF : PP-PUTM ☎



*Demandez nos fiches techniques.
Pour tout autre produit Sika,
nous consulter.*



➔ **Sika Clean Glass**
500 ml • REF : PP-PULV



➔ **Sika Clean Glass**
25 litres • REF : PP-PULV25



➔ **Collage bi-composant pour embase rétroviseur**

11 g / 10 ml - Livré avec 3 buses

REF : PP-SIKA5211NT

➔ **Jeu de 10 buses pour PP-SIKA5211NT**

REF : PP-SIKA5211NT/B



➔ **Sika Power 2910 50 ml**

Produit pour la réparation des plastiques rigides

REF : PP-SIKA2910

➔ **Buses pour Sika 2910 (paquet de 12)**

REF : PP-SIKA2910/B



➔ **Pistolet pour Sika Power 2910 50 ml**

REF : PP-SIK2900



➔ **Serti blanc Sika 527 AT**

300 ml • REF : PPP-CM7



➔ **Sika Power 4720**

Colle structurelle époxy bi-composant

REF : PP-SIKA4720



TOTALSEAL



Demandez nos fiches techniques



TEMPS DE LIBÉRATION : 1 HEURE

Colle Total Seal

Temps de libération 1 heure
310 ml • REF : PP-C001
400 ml • REF : PP-C002



Sachet de 10 buses

Pour poche 400 ml / 600 ml
• REF : PP-C002/BUSES



TEMPS DE LIBÉRATION : 2 HEURES

Colle Total Seal

Temps de libération 2 heures
400 ml • REF : PP-C009



Activateur Total Seal

250 ml • REF : PP-C006



Dégraissant Total Seal

30 ml • REF : PP-C007



Kit 180 HV

1 lingette dégraissante, 1 cartouche de colle à pare-brise,
1 stick 10 ml de primaire, 1 buse
REF : PRCOLKIT310



Dégraissant 1000 ml

Solvant doux qui n'abîme pas la peinture.
A utiliser pour enlever le surplus de colle sur la carrosserie
REF : PP-DEG1000



BUTYL souple pour étanchéité

Cartouche 300 ml
REF : PP-PUBUT-1
• Buse • REF : PP-PUBUT-1buse



Primaire verre / tôle Total Seal

30 ml • REF : PP-C003
100 ml • REF : PP-C004



*Demandez nos fiches techniques.
Pour tout autre produit Bostik,
nous consulter.*

SÉCHAGE :
1 H 30



☉ Colle Bostik MS polymère

Sans primaire - Poche 400 ml

REF : **PP-MSP0L02** ☎



SÉCHAGE :
1 H 30

☉ Colle Bostik MS polymère

Sans primaire
Cartouche 290 ml

REF : **PP-MSP0L01** ☎



☉ Primaire tôle Bostik

250 ml

REF : **PP-MSPR-250** ☎



FITGLASS PL

⇒ Outil pour la pose et dépose de vitrage PL. Un seul opérateur

Conçu pour la pose et la dépose de vitrage poids-lourds, seul et sans aucun effort.

Démontable, il peut être utilisé pour des interventions à domicile. Autonome, il fonctionne sur batterie.

Charge maxi : 50 Kg.

Livré avec son chargeur 220 V.

⇒ FITGLASS PL complet + table de retournement
REF : PPP-WST300N1





FITGLASS

⇒ Outil pour la pose et dépose de vitrage. Un seul opérateur

Conçu pour la pose et la dépose de vitrage auto et utilitaire, seul et sans aucun effort. Démontable, il peut être utilisé pour des interventions à domicile. Autonome, il fonctionne sur batterie. Charge maxi : 35 Kg. Livré avec son chargeur 220 V.



Voir la vidéo sur www.panther-pro.fr



⇒ Moteur FITGLASS Outil de pose pare-brise

REF : PPP-WST200



⇒ Support ventouse pour FITGLASS complet (avec ventouses WST391)

REF : PPP-WST200/SN

⇒ Potence pour FITGLASS

REF : PPP-WST200/P

⇒ FITGLASS complet

REF : PPP-WST200N



Couleur personnalisable

(fournissez le RAL choisi pour obtenir un devis)



⇒ Table de retournement

REF : PPP-WST200/RN



**NOUVEAU
DESIGN
+ PEINTURE
STRUCTURÉE
MATE**



Voir la vidéo sur
www.panther-pro.fr



⊕ Système de pose de vitrage automobile Lilbuddy renforcé

Permet de poser seul la majorité des vitrages automobiles.
REF : **PPP-LILB**

⊕ Ventouse automatique Lilbuddy

Les 2 leviers permettent le verrouillage de la ventouse.
La dépression se fait par simple basculement de la poignée.
Vendue à l'unité.
REF : **PPP-WST38LB**



⊕ Système de pose de vitrage automobile

Permet de poser seul la majorité des vitrages automobiles.
Ce système permet de poser des 2 côtés droit et gauche.
REF : **PPA-SOLO**



⊕ Ventouse à pompe (droite)

REF : **PPP-WST40BD**

⊕ Ventouse à pompe (gauche)

REF : **PPP-WST40BG**



⊕ Ventouse caoutchouc double succion

REF : **PPP-WST38-S**



⊕ Ventouse double tête fixe

Ø 115 mm pour vitrage plat
REF : **PPP-WST38**



⊕ Ventouse double tête articulée

Ø 115 mm - 30 kg
REF : **PPP-WST39**



⊕ Ventouse double tête articulée grosse capacité

Ø 140 mm - 35 kg
REF : **PPP-WST391**



⊕ Kit de 2 ventouses double tête articulée + sangle

Capacité : 30 kg par ventouse
REF : **PPP-WST40N**



⊕ Ventouse flexible 400 mm

Idéale pour le maintien des vitrages (custode, pare-brise)
Ø 115 mm • REF : **PPP-WST631**



⊕ Ventouse à vis 200 mm 150 kg

REF : **PPP-WH-9601H**



⊕ Ventouse à pompe 250 mm 130 kg

Pour tout vitrage, dont galbé - Idéale pour Bus et PL
REF : **PPP-WST38P10**



⊕ **Ventouse à pompe 200 mm 120 kg**
Spéciale vitrage galbé joint souple
REF : **PPP-WST38P9**



⊕ **Support de vitre de porte (ventouse)**
REF : **PPP-WST08**



⊕ **Jeu de 6 mini ventouses**
REF : **PPP-WST71**



⊕ **Plaque protège tableau de bord**
Polypro blanc 2 mm - 290 x 210 mm
REF : **PPP-WST49P**



⊕ **Jeu de 3 plaques de protection lors des déposes des vitrages**
REF : **PPP-WST49D**



⊕ **Plaque protège tableau de bord**
355 x 100 mm en aluminium
REF : **PPP-WST49**



⊕ **Plaques protège tableau de bord**
690 x 280 mm / 320 x 280 mm
REF : **PPP-WST49R2A**



⊕ **Jeu de 4 plaques de protection lors des déposes des vitrages**
REF : **PPP-WST49C**



⊕ **Couteau tableau de bord lame universelle**
Lames de remplacement : PPP-RKBD - PPP-RKB
REF : **PPP-WST46**



⊕ **Levier démonte baguette**
REF : **PS-05**



⊕ **Spatule plastique 2 bouts ronds**
REF : **PPP-WST07A**
⊕ **Spatule plastique bout rond/carré**
REF : **PPP-WST07**



⊕ **Pince à dégraffer les garnitures de portes**
REF : **PPP-WST73**



⊕ **Coin nylon H : 25 mm - L : 190 mm - l : 30 mm**
Permet de mettre en tension les agrafes sans endommager la peinture
REF : PPP-C18



⊕ **Outil monte/démonte circlips de porte**
REF : PPP-WST37



⊕ **Pince démonte circlips**
REF : PPP-WST36

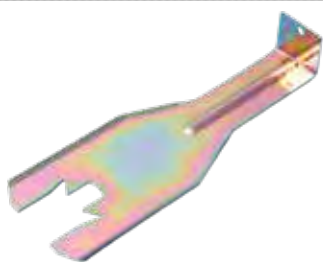

⊕ **Démonte circlips de porte**
REF : PPP-WST24



⊕ **Jeu de 5 démontes agrafe**
REF : PPP-GT0026



⊕ **Jeu de 5 outils plastique pour dépose garniture**
REF : PPP-GT0006



⊕ **Springer Tool : Outil démonte clips universels**
REF : PPP-WST73-S



⊕ **Jeu de 6 outils plastique pour dépose garniture**
REF : PPP-GT0005



⊕ **Outil démonte agrafe de porte bout en U plat**
REF : PPP-WST21



⊕ **Outil démonte panneau de porte, coudé**
REF : PPP-WST05



⊕ **Outil démonte agrafe de porte bout en V**
Idéal pour les nouvelles agrafes
REF : PPP-WST22



⊕ **Outil double crochets**
REF : PPP-WST32

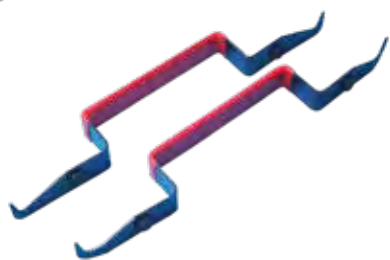

⊕ Double crochet plat
REF : PPP-WST28
⊕ Double crochet coudé
REF : PPP-WST29

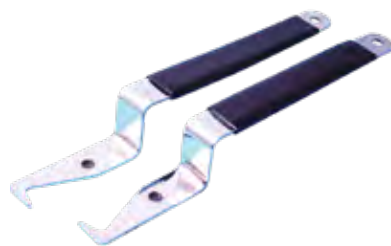

⊕ Kit crochets droit + gauche
REF : PPP-WST41N
⊕ Crochet gauche
REF : PPP-WST41A
⊕ Crochet droit
REF : PPP-WST41B



⊕ Clé démonte baguette pare-brise de ROVER
REF : PPP-WST02



⊕ Démonte baguette
REF : PS-41

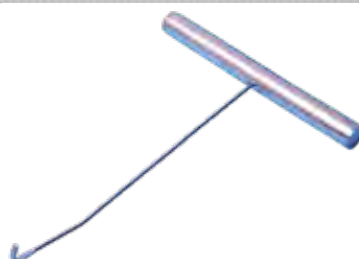

⊕ Crochet démonte circlips de porte
REF : PPP-WST24A



⊕ Kit mini crochets
REF : PPP-WST09
⊕ Kit mini crochets démontables
REF : PPP-WST10



⊕ Jeu de 6 mini crochets à joint
REF : PPP-GT0021



⊕ Jeu de 6 crochets à joint
REF : PPP-GT0031



⊕ Outil de nettoyage glissière vitre de porte
Dimension tige : 50 cm hors manche.
REF : PPP-WST64



⊕ Outil à joint bout rond coudé (Bus/PL)
REF : PPP-WST11



⊕ Crochet renforcé
REF : PPP-WST92B



⊕ Outil à joint coudé bout pointu
REF : PPP-WST17A



⊕ Outil à joint bout rond
REF : PPP-WST18



⊕ Outil à joint coudé bout pointu
REF : PPP-WST16



⊕ Outil à joint coudé bout pointu
REF : PPP-WST17



⊕ Outil à joint embout arrondi plat
REF : PS-FD



⊕ Outil à joint long plat 3,2 mm
À gratter (angles non visés)
REF : PS-FR



⊕ Outil crochet renforcé
REF : PS-HT



⊕ Outil pointu
REF : PS-SA



⊕ Démonte rétroviseur BTR : 2 mm & 2,5 mm
REF : PPP-WST04

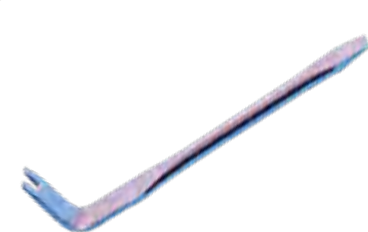

⊕ Outil dépose agrafe, plage de pare-brise FORD SIERRA
REF : PPP-WST03



⊕ Démonte pare-brise de poids lourds
REF : PPP-WST01
⊕ Démonte pare-brise de poids lourds, gainé
REF : PS-01



⊕ Outil à clé court
REF : PPP-WST15AN



⊕ Outil à clé avec embout 11, 14 & 16 mm
REF : PS-FT



⊕ **Outil à clé (embouts amovibles)**

REF : PPP-WST15N



⊕ **Jeu de 5 outils à clé 125 mm**

REF : PPP-WST42SN

⊕ **Jeu de 5 outils à clé 60 mm**

REF : PPP-WST421SN

⊕ **Outil court 60 mm (embout interchangeable)**

PPP-WST421A

Outil à clé 9,5 mm

PPP-WST421B

Outil à clé 10,5 mm

PPP-WST421C

Outil à clé 11 mm

PPP-WST421D

Outil à clé 12 mm

PPP-WST421E

Outil à clé 15 mm

⊕ **Outil long 125 mm (embout interchangeable)**

PPP-WST422A

Outil à clé 9,5 mm

PPP-WST422B

Outil à clé 10,5 mm

PPP-WST422C

Outil à clé 11 mm

PPP-WST422D

Outil à clé 12 mm

PPP-WST422E

Outil à clé 15 mm



⊕ **Porte embout 125 mm seul pour clé**

REF : PPP-WST42

⊕ **Porte embout 60 mm seul pour clé**

REF : PPP-WST421

⊕ **5 embouts de remplacement 9,5 - 15 mm**

REF : PPP-WST15TIPS



⊕ **Outil à clé de transformation**

REF : PNS-YF6125



⊕ **Graisse pour joints de pare-brise**

REF : PPP-WST70G



⊕ **Coussin gonflable**

Permet l'écartement des portes ou des pare-brise
REF : PPP-WST95



⊕ **Outil passe corde pour pare-brise à joint**

REF : PPP-WST14



⊕ **Ficelle pour pare-brise à joint 10 m**

REF : PPP-WST55-10



⊕ **Grattoir sabot de porte 7 mm**

REF : PPP-WST50B



⊕ **Outil à rasoir 15 mm**

REF : PS-50A-C

⊕ **Outil à rasoir 20 mm**

REF : PS-50-C



⊕ **Outil à rasoir 15 mm**

REF : PPP-WST50



⊕ Outil à raser 20 mm

REF : PPP-WST50A



⊕ Outil à raser 30 mm

REF : PPP-WST50D



⊕ Grattoir rétroviseur 17 mm

REF : PPP-WST50C



⊕ Outil support lame de rasoir

Lames de remplacement PPP-RB3.
REF : PPP-WST06



⊕ Outil support lame de rasoir rétractable

Lames de remplacement PPP-RB4.
REF : PPP-RB1A



⊕ Lames de remplacement vendues en page 222



⊕ Kit de 3 grattoirs

REF : PPP-WST12S



⊕ Grattoir

REF : PPP-WST12A



⊕ Outil support lame de rasoir

Lames de remplacement PPP-RB3.
REF : PPP-WST80S



⊕ Outil porte lame (raclor pro)

Sa tête en forme de vipère assure un maintien optimal et réduit la casse des lames

REF : PPP-WST80PN



⊕ Coffret cutter + couteau à raser + lames

Lames : 5 lames PPP-WST80-12, 5 lames PPP-WST80-16, 5 lames PPP-WST80-20.

REF : PPP-WST80



⊕ Outil porte lame (raclor pro) manche nylon strié

Sa tête en forme de vipère assure un maintien optimal et réduit la casse des lames

REF : PPP-WST80PN1



⊕ Levier dépose enjoliveur avec protection
REF : PPP-WST12C



⊕ Outil support lame de rasoir (manche long)
REF : PPP-WST06A



⊕ Extracteur essuie-glace
REF : PPP-WST51A



⊕ Extracteur essuie-glace Ø 0 à 35 mm L : 40 mm
REF : PPP-WST51C
⊕ Extracteur essuie-glace Ø 0 à 35 mm L : 60 mm
REF : PPP-WST51C1



⊕ Extracteur essuie-glace avec embase réglable en largeur
REF : PPP-WST51X



⊕ Extracteur essuie-glace
REF : PPP-WST51A



⊕ Embout Torx 80 (BMW E38/E39/E31)
REF : PPP-SCA-TX80



⊕ Grand extracteur essuie-glace
REF : PPP-WST51T



⊕ Extracteur essuie-glace
REF : PPP-WST51B



⊕ Arrache essuie-glace (bras réglables)
Le trou dans l'axe permet de déposer les bras d'essuie-glace avec gicleur incorporé
REF : PPP-WST51F



⊕ Extracteur essuie-glace
REF : PPP-WST51D



⊕ Jeu de 9 extracteurs à utiliser avec le marteau à inertie ou l'axe presseur
REF : PPP-WST51Z



⊕ Arrache essuie-glace universel

Avec 2 jeux de bras réglables et amovibles
REF : **PPP-WST51G**



⊕ Arrache essuie-glace

Utilisé pour les bras en plastique généralement pour les lunettes
arrière type Renault Espace / Scenic...
REF : **PPP-WST51P**



⊕ Table à pare-brise

REF : **PPP-WST53A**



⊕ Jeu de 4 ventouses pour table PPP-WST53A

REF : **PPP-WST53A-PADS**



⊕ Entretoise pour gicleur de lave-glace

REF : **PPP-WST51R**



⊕ Table à pare-brise

REF : **PPP-WST53C**



⊕ CONTACTEZ-NOUS
POUR PLUS D'INFORMATIONS

⊕ Système de rails / barres télescopiques pour sécuriser le transport de vos vitrages

Kit 4 barres avec 4 mousses et 2 rails • REF : **PPP-WST72KITRAIL**
Barre télescopique Ø 19 mm 2200 à 2600 mm • REF : **PPP-WST72BT**
Mousse pour barre télescopique • REF : **PPP-WST72MBT**
Lot de 2 rails type aéro 1500 mm • REF : **PPP-WST72RE**

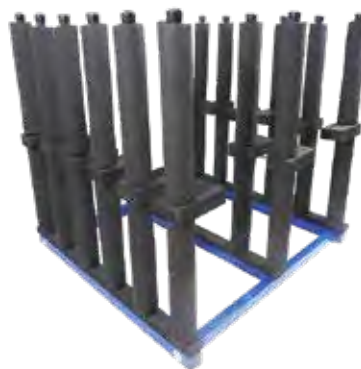

⊕ Rack à vitrage automobile (5 pare-brise)

76 x 76 x 76 cm
REF : **PPP-WST72N**



⊕ Rack à vitrage automobile (36 pare-brise)

200 x 250 x 110 cm
REF : **PPP-WST72-BOIS**





⊕ **Tampons boules x 100**

L : 100 mm • REF : PPP-WST54A
L : 130 mm • REF : PPP-WST54
L : 180 mm • REF : PPP-WST54B



⊕ **Tampon applicateur (type coton tige) x 100**

Idéal pour l'application de primaire ou pour de petites retouches
L : 150 mm
REF : PPP-WST54W



⊕ **3 outils démonte capteur pluie/lumière**

REF : PPP-WST69



⊕ **Pulvérisateur 500 ml**

REF : PPP-WST65



⊕ **Pulvérisateur à pompe 2 L**

Convient aux produits chimiques
REF : PPP-WST65-2



⊕ **Butyl à froid 8 mm x 4.5 m**

REF : PPP-WST62D/1

⊕ **Butyl à froid 9.5 mm x 6.5 m**

REF : PPP-WST62D/2



⊕ **Mousse anti débord 5 mm x 5 mm x 10 m**

REF : PPP-WST62MOUSSE

⊕ **Mousse anti débord 4,5 mm x 4,5 mm x 5,5 m**

REF : PPP-WST62MOUSSE/1

⊕ **Mousse anti débord 20 mm x 20 mm x 2 m**

REF : PPP-WST62MOUSSE/2



⊕ **Pack de 50 portes contrôle technique**

REF : PPP-WST74CT



⊕ **Pack de 100 portes vignette assurance**

REF : PPP-WST74



⊕ **Blocs de caoutchouc x 100 - 35 x 6 x 9 mm**

REF : PPP-WST61C

⊕ **Blocs de caoutchouc x 100 - 30 x 4 x 4 mm**

REF : PPP-WST61C1



⊕ **PROFIL INTÉRIEUR PB 10 mm x 23 m avec adhésif**

REF : PPP-JT16



⊕ **PROFIL INTÉRIEUR PB « mousse » 9,5 mm x 23 m avec adhésif**

REF : PPP-JT20



➔ PROFIL UNIVERSEL PVC Profil PB 16 mm avec butyl rouleau 30 m
REF : PPP-JT003

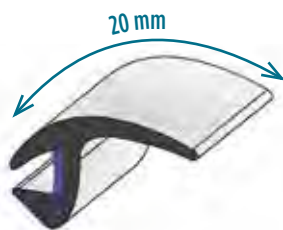

➔ PROFIL UNIVERSEL PVC Profil PB 20 mm avec butyl rouleau 23 m
REF : PPP-JT004



➔ PROFIL UNIVERSEL PVC Profil PB 25 mm avec butyl rouleau 23 m
REF : PPP-JT005



Voir la vidéo sur
www.panther-pro.fr



➔ PROFIL INTERIEUR PB « mousse » 8 mm x 23 m avec adhésif
REF : PPP-JT099



➔ PROFIL UNIVERSEL PVC Profil PB Rouleau 30 m.
REF : PPP-JT112



➔ PROFIL UNIVERSEL "TENUE EXTREME" Profil PB 16 mm avec butyl rouleau 22,8 m

Fabriqu  avec un caoutchouc synth tique qui donne une grande souplesse pour  pouser la forme du verre en toute saison. Nous utilisons un butyl de haute qualit  pour assurer la meilleure adh rence au verre. • REF : PPP-JT033



➔ PROFIL UNIVERSEL "TENUE EXTREME" Profil PB 19 mm avec butyl rouleau 22,8 m

Fabriqu  avec un caoutchouc synth tique qui donne une grande souplesse pour  pouser la forme du verre en toute saison. Nous utilisons un butyl de haute qualit  pour assurer la meilleure adh rence au verre. • REF : PPP-JT044



➔ PROFIL UNIVERSEL "TENUE EXTREME" Profil PB 25 mm avec butyl rouleau 22,8 m

Fabriqu  avec un caoutchouc synth tique qui donne une grande souplesse pour  pouser la forme du verre en toute saison. Nous utilisons un butyl de haute qualit  pour assurer la meilleure adh rence au verre. • REF : PPP-JT055



➔ PROFIL UNIVERSEL "TENUE EXTREME" Profil PB 31 mm avec butyl rouleau 15,2 m

Fabriqu  avec un caoutchouc synth tique qui donne une grande souplesse pour  pouser la forme du verre en toute saison. Nous utilisons un butyl de haute qualit  pour assurer la meilleure adh rence au verre. • REF : PPP-JT111



➔ PROFIL UNIVERSEL "TENUE EXTREME" Profil PB 16 mm avec butyl rouleau 22,8 m

Fabriqu  avec un caoutchouc synth tique qui donne une grande souplesse pour  pouser la forme du verre en toute saison. Nous utilisons un butyl de haute qualit  pour assurer la meilleure adh rence au verre. • REF : PPP-JT022



➔ PROFIL UNIVERSEL "TENUE EXTREME" Profil PB 7 mm avec butyl rouleau 22,8 m
REF : PPP-JT066

➔ PROFIL UNIVERSEL "TENUE EXTREME" Profil PB 9,5 mm avec butyl rouleau 22,8 m • REF : PPP-JT077

Fabriqu  avec un caoutchouc synth tique qui donne une grande souplesse pour  pouser la forme du verre en toute saison. Nous utilisons un butyl de haute qualit  pour assurer la meilleure adh rence au verre.



➔ PROFIL UNIVERSEL "TENUE EXTREME" Profil PB 8 mm avec butyl rouleau 22,8 m

Fabriqu  avec un caoutchouc synth tique qui donne une grande souplesse pour  pouser la forme du verre en toute saison. Nous utilisons un butyl de haute qualit  pour assurer la meilleure adh rence au verre. • REF : PPP-JT088





⊙ Kit complet de 35 outils pour la pose de pare-brise

Livré en caisse plastique résistante avec mousse bi-color.

Vous n'oublierez plus vos outils !

REF : PPP-WSTKITPBN



⊙ Kit 24 outils pour pare-brise

Nécessaire de base pour la dépose et repose du vitrage automobile.

Livré avec une caisse à outils 2 compartiments.

REF : PPP-WSTKITPBN/1





NOUVEAU



AUTOREP MINI SYSTEME DE REPARATION D'IMPACT AUTOMATIQUE AUTONOME

☉ Vous choisissez votre type d'impact à réparer sur le menu déroulant de l'AUTOREP, vous validez et la machine travaille pour vous. La qualité des résultats obtenus a déjà conquis de nombreux clients.
DEMANDEZ UNE DEMONSTRATION !

Tous les AUTOREP sont livrés avec un chargeur 220V et un cordon allume cigare pour la charge de la machine.

☉ Autorep Mini

Système de réparation automatique complet

REF : PPP-WST99N1-MINI

☉ Valise vendue sans accessoire

REF : PPP-WST99N-MINI

Ecran de contrôle de toutes les fonctions en 2 langues : Français et Anglais



Voir la vidéo sur
www.panther-pro.fr



☉ Autorep Pocket

Système de réparation semi-automatisé, alimentation 12V (allume-cigare).

Ce kit est livré avec :

- Châssis Autorep Pocket
- Pont de réparation (PPA-FIX2001)
- Tuyau d'air (1,5 m)
- Lampe UV 3 Leds
- Miroir
- Cordon d'alimentation avec prise allume-cigare 12V

REF : PPP-WST88N



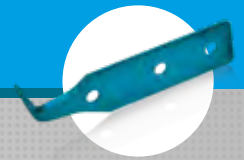

⊕ Kit de réparation de pare-brise Advantage

Procédé utilisant une pompe pour une gestion plus précise de la dépression / pression.

REF : PPA-1500

⊕ Kit de réparation de pare-brise « Vertical » - Utilisé pour les pare-brise verticaux (bus, poids lourd)

Procédé utilisant une pompe pour une gestion plus précise de la dépression / pression.

REF : PPA-1550N



⊕ Kit de réparation de pare-brise Suprême

Procédé utilisant une pompe pour une gestion plus précise de la dépression / pression.

Lampe 2 branchements : allume cigare / 220V

REF : PPA-1400



⊕ Kit de réparation de pare-brise (pompe Advantage)

Procédé utilisant une pompe pour une gestion plus précise de la dépression / pression.

REF : PPA-1625N



⊕ Kit de réparation de pare-brise complet

Procédé utilisant des injecteurs plastique. Utilisation simple

REF : P10001N



⊕ Kit de réparation de pare-brise Réduit

Procédé utilisant des injecteurs plastique. Utilisation simple

REF : P10001AN



⊕ Support d'outil d'injection réglable
REF : PPD-840300



⊕ Support d'outil d'injection vertical
REF : PPA-FIX2002



⊕ Support d'outil d'injection réglable
REF : PPA-FIX2000



⊕ Support injecteur simplifié
REF : PPA-FIX2001



⊕ Support d'outil d'injection fixe
REF : PPD-980100



⊕ Joint de ventouse Aegis pour :
PPA-FIX2002/2000 et PPP-WST40BD/BG
REF : PPA-FIX5019



⊕ Injecteur embout souple
REF : PPD-882140



⊕ Chambre 3/16''
Longueur filtage : 2,8 mm
REF : PPA-FIX2006



⊕ Chambre 3/16'' Pro
Longueur filtage : 4,8 mm
REF : PPA-FIX2007



⊕ Chambre 3/8'' (9,5 mm)
REF : PPA-FIX2005



⊕ Adaptateur 3/8'' x 5
REF : PPA-SBX2010
⊕ Adaptateur 3/16'' x 5
REF : PPA-SBX2016



⊕ Joint pour tuyau x 2
Pour P10052 / P10053 / PPA-HOS2000
REF : PPA-HOS2010



- ⊕ Rep-res résine de réparation œil de boeuf 15 ml
REF : P20013N
- ⊕ Rep-res résine de réparation étoile/fentes 15 ml
REF : P20013LN
- ⊕ Rep-res résine de finition 5 ml
REF : P20015N



- ⊕ Résine de réparation 5 ml • REF : P10011N
- ⊕ Résine de réparation 10 ml • REF : P10012N
- ⊕ Résine de réparation 15 ml • REF : P10013N
- ⊕ Résine de réparation 15 ml fluide • REF : P10013LN
- ⊕ Résine de finition 5 ml • REF : P10015N
- ⊕ Résine de finition 10 ml • REF : P10016N
- ⊕ Résine de finition 15 ml • REF : P10014N



- ⊕ Résine de réparation Inodorous 15 ml fluide
Faible odeur - Polymérise rapidement
REF : P30013LN
- ⊕ Résine de finition Inodorous 5 ml
Faible odeur - Polymérise rapidement
REF : P30015LN



- ⊕ Kit de réparation injecteur + résine 1,5 ml
Vendu en sachet
REF : PPD-842000



- ⊕ Chambre verticale 3/16" (4,8 mm)
Petits / moyens impacts
REF : PPA-FIX5059



- ⊕ Chambre verticale 3/8" (9,5 mm)
Gros impacts
REF : PPA-FIX5062



- ⊕ Vis aluminium pour chambre verticale
PPA-FIX5069 PPA-FIX5062
REF : PPA-FIX5063



- ⊕ Pompe advantage
REF : PPA-PMP2003



- ⊕ Pompe suprême
REF : PPA-PMP2002



- ⊕ Tuyau 2,5 m bus/PL
REF : P10053



- ⊕ Glace d'inspection
REF : PPD-841500



- ⊕ Glace d'inspection
REF : P10027



⊕ **Glace d'inspection 80 x 80 mm**
REF : P10027B
⊕ **Glace d'inspection 95 x 95 mm**
REF : P10027C



⊕ **Glace d'inspection**
REF : PPA-MIR2000



⊕ **Lampe UV 8W 220V**
REF : P100078WN



⊕ **Lampe UV 2 branchements : allume cigare / 220V**
REF : PPA-LMP2006N
⊕ **Chargeur 220V**
REF : PPA-LMP5027



⊕ **Lampe UV Led rechargeable 9V**
REF : PPD-770247N



⊕ **Lampe UV à piles**
REF : P10008N

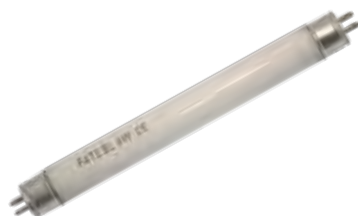

⊕ **Ampoule UV 4W**
130 mm - Pour lampes PPA-LMP2006N et P1008N
• REF : P1006A
⊕ **Ampoule UV 8W**
300 mm - Pour lampe P100078WN
• REF : P1006B



⊕ **Stylo lampe**
REF : PPD-841300



⊕ **Mini perceuse 12V**
REF : P10039M.PN



⊕ **Kit mini perceuse 12V 2.0ah (sans fil)**
Livrée avec des pinces de 0,8 à 3,2 mm, batterie + chargeur
REF : PPP-MILDREMI2V
⊕ **Mini perceuse 12V (sans fil) seule**
Livrée avec des pinces de 0,8 à 3,2 mm
REF : PPP-MIL4933427183



⊕ **Mini perceuse 220 V**
Livrée avec transformateur 240 V - 12 V
REF : P10039-220V



⊕ **Foret carbure 0,8 mm**
Vendu à l'unité • REF : P10018B
⊕ **Foret carbure 1 mm**
Vendu à l'unité • REF : P10018
⊕ **Foret demi boule 1 mm**
Vendu à l'unité • REF : PPD-841900

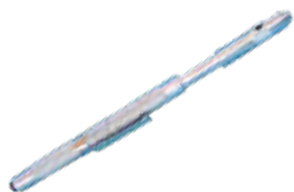

⊕ Crayon à gratter pointe carbure
REF : PPD-841400



⊕ 5 kits d'injection (seringue / aiguille)
REF : P10023



⊕ Embout de polissage
REF : PPD-842300



⊕ Feuille UV x 25
REF : PPD-840600



⊕ Polish de finition 100 ml
REF : PPD-84120A



⊕ Gel pour ventouse 20 g
REF : P10020N



⊕ 2 brosses de nettoyage injecteur
REF : PPA-BRUSHN



⊕ Prise allume cigare pour PPD-840100
REF : PPD-842202

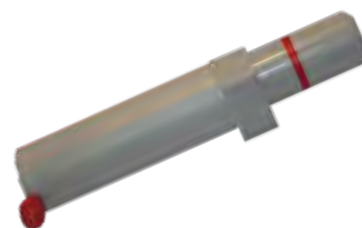

⊕ Pompe de remplacement pour
PPA-FIX2002/2000 et PPP-WST40BD/BG
REF : PPA-FIX2025



⊕ **Kit de tatouage complet**

REF : PP-TATCOMPN

⊕ **Bidon d'abrasif 1 kg**

REF : PP-TATBDN

⊕ **Kit de chiffres**

REF : PP-TATCHIF

⊕ **Kit de lettres**

REF : PP-TATLET

⊕ **Pochoir**

REF : PP-TATPLA



⊕ **Détecteur de fuite à ultrasons**

Pour un meilleur résultat, positionner l'émetteur et le récepteur les plus proches possible l'un de l'autre

REF : PPP-LDP-1



⊕ **Feutre de dérayage pour vitrage**

Ø 60 mm • REF : PPP-WST83

⊕ **Poudre de dérayage pour vitrage**

100 g • REF : PPP-WST83-P



⊕ Kit de restauration des phares en polycarbonate Mirka

- 1 ponceuse orbitale
- 1 polisseuse / lustreuse
- 2 mousses de finition
- 1 pot de polish 1 L
- 1 boîte de P500
- 1 boîte de P800
- 1 boîte de P1000
- 1 boîte de P3000
- 1 kit abrasif de 60 disques et polish plexi / polycarbonate

REF : **PPP-KITPHARE-MIRKA**



⊕ Abrasifs Ø 75 mm P500 (x50)

Ponçage eau
REF : **PCD-1MIRKA**



⊕ Abrasifs Ø 75 mm P800 (x50)

Ponçage eau
REF : **PCD-3MIRKA**



⊕ Abrasifs Ø 75 mm P1000 (x50)

Ponçage eau
REF : **PCD-4MIRKA**



⊕ Abrasifs Ø 75 mm P3000 (x50)

Ponçage eau
REF : **PCD-5MIRKA**



⊕ Interface velcro ultra fin

REF : **PPP-C15**



⊕ Flacon Polarshine 10 pour polycarbonate

1L
REF : **PPP-POLIPHARE-MIRKA-1L**



⊕ Mousse de lustrage « ferme » orange Ø 76 mm

REF : **PPP-C13**



⊕ Mousse de lustrage « finition » noire Ø 76 mm

REF : **PPP-C14**





⊕ Echafaudage

Hauteur : 1600 mm / Largeur : 1400 mm / Longueur : 2500 mm / Roue Ø 120 mm

REF : **PPP-ECHA1-2500N**



⊕ Echafaudage

Hauteur : 1600 mm / Largeur : 1400 mm / Longueur : 3000 mm / Roue Ø 120 mm

REF : **PPP-ECHA1-3000N**



⊕ Echafaudage

Hauteur : 1600 mm / Largeur : 1400 mm / Longueur : 2500 mm / Roue Ø 200 mm

Roues réglables • REF : **PPP-ECHA2-2500N**



⊕ Echafaudage

Hauteur : 1600 mm / Largeur : 1400 mm / Longueur : 3000 mm / Roue Ø 200 mm

Roues réglables • REF : **PPP-ECHA2-3000N**



⊕ Echafaudage

Hauteur : 1600 mm / Largeur : 1400 mm / Longueur : 2500 mm / Roue Ø 200 mm

Roues réglables • REF : **PPP-ECHA3-2500N**



⊕ Echafaudage

Hauteur : 1600 mm / Largeur : 1400 mm / Longueur : 3000 mm / Roue Ø 200 mm

Roues réglables • REF : **PPP-ECHA3-3000N**





⊕ **Gel pastille rétroviseur universel (kit) - 6 ml** • REF : **PPP-WST61KITZ**
 ⊕ **Sachet de 10 buses pour seringue gel capteur**
 REF : **PPP-WST61KITZ/BUSES**

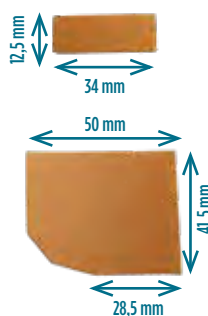

⊕ **Pastille détecteur de lumière**
 pour : Mercedes version W203 1
 Vendue à l'unité • REF : **PPP-WST61A**

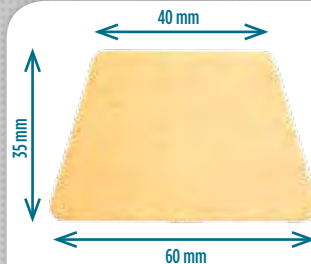

⊕ **Pastille détecteur de pluie pour :**
 Grand Cherokee 2002+ / Daewoo Nubira
 09/'03+ / Kia Carnival 2002+ / Carens & Opirus
 2003+ / Honda Accord 2003+ / Hyundai Trajet
 1999+ / Nissan Primera 2002+
 Vendue à l'unité • REF : **PPP-WST61B**



⊕ **Pastille détecteur de pluie pour :**
 BMW E38 de '94-'98/'98-'01 / E39 de '95-'09/'01
 Mercedes W203 de '00-'05/'0 W210 de '95-'02
 Rover et Alfa Romeo
 Vendue à l'unité
 REF : **PPP-WST61D**

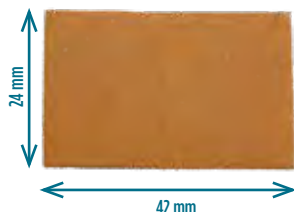

⊕ **Pastille détecteur de pluie et lumière pour :**
 Lexus GS '05 IS 200 '05 / IS 400 '00 RX 300 '03
 Vendue à l'unité
 REF : **PPP-WST61E**

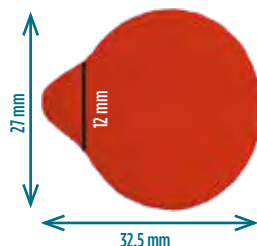

⊕ **Pastille détecteur de pluie et lumière pour :**
 Audi A3 '03 / A4 '04/'05 / A6/'04 / A8 07/'03 /
 Q7 '06 Opel Zafira II '05. Vendue à l'unité
 REF : **PPP-WST61F**

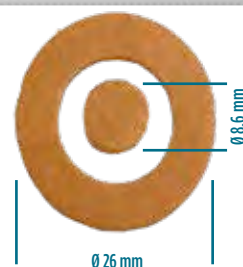

⊕ **Pastille détecteur de pluie et lumière pour :**
 VW ancien modèle. Vendue à l'unité
 REF : **PPP-WST61H**



⊕ **Pastille détecteur de pluie et lumière pour :**
 BMW E46 / E39 / E60 / E65 / X5 et Z4 à partir
 de 09/'01 Mercedes M-Class à partir de 09/'01
 Peugeot 206 Cabrio/406 Coupé
 Vendue à l'unité • REF : **PPP-WST61G**

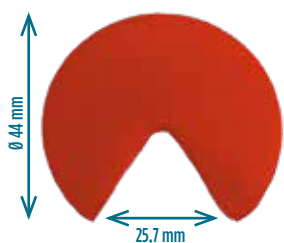

⊕ **Pastille détecteur de pluie et lumière pour :**
 Renault Mégane Nissan Micra K12
 Vendue à l'unité
 REF : **PPP-WST61J**



⊕ **Pastille détecteur de pluie et lumière pour :**
 VW Jaguar. Vendue à l'unité
 REF : **PPP-WST61I**



⊕ **Pastille détecteur de pluie et lumière pour :**
 Seat Alambra VAG Sharan 2010
 Vendue à l'unité
 REF : **PPP-WST61K**



⊕ **Pastille détecteur de pluie et lumière pour :**
 BMW E60/61/F07/E70/E71/E72 Renault Kangoo
 / Koleos / Mégane 3 / Laguna 2007
 Vendue à l'unité
 REF : **PPP-WST61L**



⊕ **Pastille détecteur pluie / lumière silicone 27 mm**
 ALFA CITROEN FIAT MERCEDES
 Vendue à l'unité
 REF : **PPP-WST61SIL1**

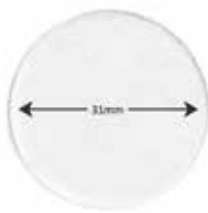

⊕ **Pastille détecteur pluie / lumière silicone 31 mm**
 AUDI BMW BUICK CADILLAC
 Vendue à l'unité
 REF : **PPP-WST61SIL2**

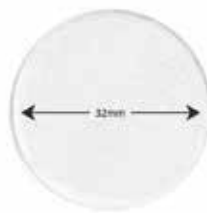

⊕ **Pastille détecteur pluie / lumière silicone 32 mm**
 SEAT SKODA VW
 Vendue à l'unité
 REF : **PPP-WST61SIL3**



➔ Pastille détecteur pluie / lumière silicone 44 mm

FIAT FORD MERCEDES NISSAN RENAULT SETRA
Vendue à l'unité
REF : PPP-WST61SIL4



➔ Pastille détecteur pluie / lumière silicone 44 mm

BMW NISSAN RENAULT SMART
Vendue à l'unité
REF : PPP-WST61SIL5

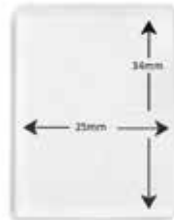

➔ Pastille détecteur pluie / lumière silicone 34 mm

LEXUS MAZDA SUBARU TOYOTA
Vendue à l'unité
REF : PPP-WST61SIL7



➔ Pastille détecteur pluie / lumière silicone 50 mm

FORD JAGUAR LAND ROVER PORSCHE SEAT
SKODA VW. Vendue à l'unité
REF : PPP-WST61SIL6



➔ Pastille détecteur pluie / lumière silicone 27x33 mm

ALFA AUDI FIAT FORD OPEL SEAT TOYOTA VOLVO
Vendue à l'unité
REF : PPP-WST61SIL8



➔ Pastille détecteur pluie / lumière silicone 31x45 mm

CITROEN JAGUAR LAND ROVER PEUGEOT
Vendue à l'unité
REF : PPP-WST61SIL9



➔ Pastilles rétro Ford x 50

REF : PPP-WST61



➔ Film adhésif 50 m L : 600 mm

REF : PPP-WST66F





⊕ **Kit réparation connectique lunette**
REF : PPP-EQ-DRK672



⊕ **Kit bi-composant pour connectique dégivrage**
REF : PPP-EQ-TBA674



⊕ **Liquide de réparation pour réseau chauffant lunette**
REF : PPP-EQ-TGR677



⊕ **Pâte à souder pour support connectique**
REF : PPP-EQ-TPS676



⊕ **Malette chauffe cartouche**
REF : PPP-EQ-HWM618



⊕ **Grand cutter Ultrawiz 33 cm**
Lames de remplacement : PPP-RKB
REF : PPP-WST31L3



⊕ **Grand cutter Ultrawiz 45 cm**
Lames de remplacement : PPP-RKB
REF : PPP-WST31L18



⊕ **Grand cutter Ultrawiz 60 cm**
Lames de remplacement : PPP-RKB
REF : PPP-WST31L24





Découpe

COUTEAUX, SCIES, LAMES, CUTTERS, CISAILLES, ...





⊕ Lames de rasoir 0,22 mm

Boîte de 100 lames - supports vendus pages 25 et 26 • REF : **PPP-RB3**

⊕ Lames de rasoir 0,30 mm

Boîte de 100 lames - supports vendus pages 25 et 26 • REF : **PPP-RB4**



⊕ Lames de rasoir

Boîte de 10 lames
REF : **PPP-1443A**



⊕ Lames de cutter cassables 9 mm

Boîte de 10 lames
REF : **PPP-1403B**



⊕ Lames de cutter cassables 9 mm inox

Boîte de 10 lames
REF : **PPP-1403B-INOX**



⊕ Lames de cutter cassables 18 mm

Boîte de 10 lames
REF : **PPP-1404B**



⊕ Lames de cutter non cassables 18 mm

Boîte de 10 lames
REF : **PPP-1404BA**



⊕ Lames couteau universel

Boîte de 100 lames
REF : **PPP-RKB**



⊕ Lames pour couteau universel avec récupérateur

Boîte de 100 lames
REF : **PPP-RKBD**



⊕ Lames Olfa 25 mm

Boîte de 20 lames
• REF : **POL-HB-20B**

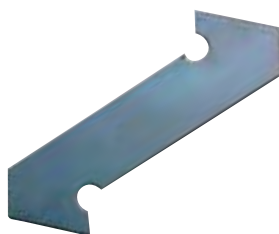

⊕ Lames Olfa plexiglass

Boîte de 3 lames
REF : **POL-PB-800**



⊕ Lames pour couteau à araser

Boîte de 5 lames
REF : **PPP-WST30B**

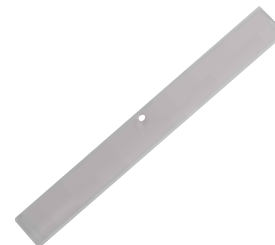

⊕ Lames pour outil à araser 100 mm

Boîte de 5 lames
REF : **PPP-WST58B**



⊕ Lames pour outil à araser large

Boîte de 5 lames
REF : **PPP-WST59B**



⊕ Lames 12 mm pour couteau à araser

Boîte de 10 lames
REF : **PPP-WST80-12**

⊕ Lames 16 mm pour couteau à araser

Boîte de 10 lames
REF : **PPP-WST80-16**

⊕ Lames 20 mm pour couteau à araser

Boîte de 10 lames
REF : **PPP-WST80-20**



⊕ Lame à araser 19 mm pour couteau à main

REF : **PPP-WST30C**



⊕ **Cutter lame 18 mm rétractable OLFA**
Lames de remplacement : PPP-1404B et PPP-1404BA
REF : **POL-NOL-1**



⊕ **Grand cutter lame 18 mm rétractable OLFA**
Lames de remplacement : PPP-1404B et PPP-1404BA
REF : **POL-XL2**



⊕ **Cutter gros travaux lame 25 mm OLFA**
Lames de remplacement : POL-HB-20B
REF : **POL-H-1**



⊕ **Couteau silver lame 9 mm OLFA**
Lames de remplacement : PPP-1403B
REF : **POL-SVR-1**



⊕ **Cutter plexiglass OLFA**
Lames de remplacement : POL-PB-800
REF : **POL-PC-L**



⊕ **Couteau à lame trapézoïdale rétractable automatique**
Lames de remplacement : PPP-RKB et PPP-RKBD
REF : **PPP-RK5**

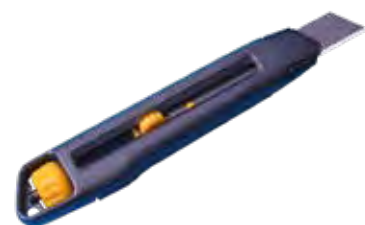

⊕ **Couteau Stanley lame 18 mm**
Lames de remplacement : PPP-1404B et PPP-1404BA
REF : **PSTAN-018**



⊕ **Cutter renforcé lame universelle fixe**
Lames de remplacement : PPP-RKB et PPP-RKBD
REF : **PPP-RK3**



⊕ **Couteau lame rétractable trapézoïdale**
Lames de remplacement : PPP-RKB et PPP-RKBD
REF : **PPP-RK1**



⊕ **Couteau à lame fixe trapézoïdale**
Lames de remplacement : PPP-RKB et PPP-RKBD
REF : **PPP-RK4**



⊕ **Cutter lame 9 mm**
Lames de remplacement : PPP-1403B ou PPP-1404B et PPP-1404BA
REF : **PPP-L301**
⊕ **Cutter lame 18 mm**
Lames de remplacement : PPP-1403B ou PPP-1404B et PPP-1404BA
REF : **PPP-L651**



⊕ **Cutter rétractable à chargement automatique**
Lames de remplacement : PPP-1404B et PPP-1404BA
REF : **TT-SCAD1817**



⊕ Coffret cisaille multi fonction
REF : PPP-WST44



⊕ Jeu de cutters pour modélisme
REF : PNS-HKS



⊕ Outil à agrafer lame large
Lames de remplacement : PPP-WST59B
REF : PPP-WST59



⊕ Cutter pour verre ordinaire
REF : PWS-CM304A

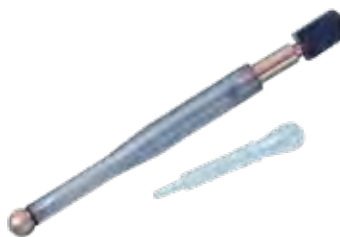

⊕ Cutter pour verre tête orientable avec réservoir d'huile
REF : PWS-GC-0301



⊕ Kit de 8 pièces (couteau peintre, à démastiquer, d'angle, sabre)
REF : PPP-SCW8SN
⊕ Couteau à démastiquer manche bois
REF : PPP-HK
⊕ Sabre de colleur manche bois
REF : PPP-PK1
⊕ Couteau d'angle à mastiquer manche bois
REF : PPP-PKA
⊕ Outil à agrafer 25 mm manche bois
REF : PPP-SC25W
⊕ Outil à agrafer 37 mm manche bois
REF : PPP-SC37W
⊕ Outil à agrafer 50 mm manche bois
REF : PPP-SC50W
⊕ Couteau peintre 75 mm manche bois
REF : PPP-SC75W
⊕ Couteau peintre 100 mm manche bois
REF : PPP-SC100W



⊕ Outil à agrafer 32 mm manche nylon
Couteau peintre manche nylon • REF : PPP-SC32
⊕ Outil à agrafer 37 mm manche nylon
Couteau peintre manche nylon • REF : PPP-SC37
⊕ Outil à agrafer 50 mm manche nylon
Couteau peintre manche nylon • REF : PPP-SC50



⊕ Cutter plexiglass
REF : PPP-WST52



⊕ Cutter plexiglass
REF : PPP-WST52A



⊕ Jeu de 4 grattoirs
REF : PPP-GT0007



⊕ Scie à métaux

REF : TT-SAAA3013



⊕ Jeu de 3 cisailles tôle aviation

REF : PPP-TS01SET

⊕ Cisaille tôle aviation coupe gauche (rouge)

REF : PPP-TS01L

⊕ Cisaille tôle aviation coupe droite (verte)

REF : PPP-TS01R

⊕ Cisaille tôle aviation coupe droit (jaune)

REF : PPP-TS01S



⊕ Jeu de 3 cisailles tôle aviation renforcées

REF : PPP-TS02SET

⊕ Cisaille tôle aviation renforcée coupe gauche

REF : PPP-TS02L

⊕ Cisaille tôle aviation renforcée coupe droite

REF : PPP-TS02R

⊕ Cisaille tôle aviation renforcée coupe droit

REF : PPP-TS02S



⊕ Jeu de 4 cisailles universelles type "anglais"

REF : PPP-TS04SN

⊕ Cisaille universelle type « anglais »

200 mm • REF : PPP-TS08

250 mm • REF : PPP-TS10

300 mm • REF : PPP-TS12

350 mm • REF : PPP-TS14



Outillage à main

TOURNEVIS, CLÉS, PINCES, ...



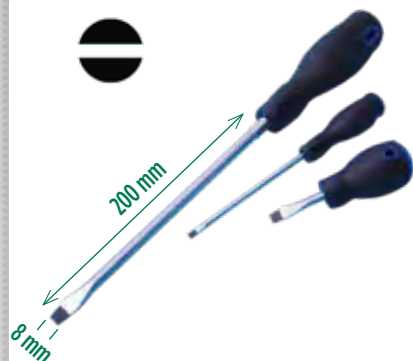

⊕ Tournevis ergonomique plat

REF : PPP-ESD-5.5X38
 REF : PPP-ESD-6.5X38
 REF : PPP-ESD-3.2X75
 REF : PPP-ESD-4X100
 REF : PPP-ESD-5.5X125
 REF : PPP-ESD-6.5X150
 REF : PPP-ESD-8X200



⊕ Tournevis ergonomique Phillips

REF : PPP-ESD-PH1X38
 REF : PPP-ESD-PH2X38
 REF : PPP-ESD-PH0X75
 REF : PPP-ESD-PH1X75
 REF : PPP-ESD-PH2X100
 REF : PPP-ESD-PH3X150



⊕ Tournevis ergonomique Pozidriv

REF : PPP-ESD-PZ0X75
 REF : PPP-ESD-PZ1X75
 REF : PPP-ESD-PZ2X100
 REF : PPP-ESD-PZ3X150



⊕ Tournevis Etoile / Etoile percée

REF : PPP-ESD-T10X100 / TH10X100
 REF : PPP-ESD-T15X100 / TH15X100
 REF : PPP-ESD-T20X100 / TH20X100
 REF : PPP-ESD-T25X100 / TH25X100
 REF : PPP-ESD-T27X100 / TH27X100
 REF : PPP-ESD-T30X100 / TH30X100
 REF : PPP-ESD-T40X100 / TH40X100



⊕ Jeu de 7 tournevis manche ergonomique

Plat : 3.2x75, 4x100, 5.5x125, 6.5x150
 Phillips : PH0x75, PH1x75, PH2x100
 REF : PPP-J3007L



⊕ Jeu de 7 tournevis manche ergonomique

T10x100, T15x100, T20x100, T25x100, T27x100, T30x100, T40x100
 REF : TT-GAAT0813 (étoile)
 T10x100, T15x100, T20x100, T25x100, T27x100, T30x100, T40x100
 REF : PPP-J3007TSL (étoile percée)



⊕ Jeu de 4 tournevis manche ergonomique

Pozidriv - PZ0x75, PZ1x75, PZ2x100, PZ3x150
 REF : PPP-J3004L



⊕ Jeu de 6 tournevis manche ergonomique

Plat : 5.5x38, 6.5x38, 8x200
 Phillips : PH1x38, PH2x38, PH3x150
 REF : PPP-J3006L



⊕ **Jeu de 19 tournevis**

REF : PPP-SDSET19

⊕ **Tournevis en Z**

PZ1 & PZ2 • REF : PPP-SDCP1XP2

⊕ **Tournevis plat**

3,2 x 100 mm • REF : PPP-SDF3.ZX100

5 x 250 mm • REF : PPP-SDF5XZ50

6 x 150 mm • REF : PPP-SDF6X150

6 x 40 mm • REF : PPP-SDF6X40

⊕ **Tournevis pozidriv**

PZ1 x 40 mm • REF : PPP-SDPZ1X40

PZ1 x 75 mm • REF : PPP-SDPZ1X75

PZ2 x 100 mm • REF : PPP-SDPZ2X100

PZ2 x 250 mm • REF : PPP-SDPZ2X250

PZ2 x 40 mm • REF : PPP-SDPZ2X40

PZ3 x 150 mm • REF : PPP-SDPZ3X150

⊕ **Tournevis étoile**

T09 x 75 mm • REF : PPP-SDT19X75

T10 x 75 mm • REF : PPP-SDT10X75

T15 x 100 mm • REF : PPP-SDT15X100

T20 x 100 mm • REF : PPP-SDT20X100

T25 x 100 mm • REF : PPP-SDT25X100

T30 x 100 mm • REF : PPP-SDT30X100

T40 x 100 mm • REF : PPP-SDT40X100

T45 x 100 mm • REF : PPP-SDT45X100



⊕ **Tournevis porte embout à friction + jeu de 45 embouts**

REF : PPP-SDK45



⊕ **Jeu de tournevis pour téléphone portable**

1 Plat : 4 mm - 6,5 mm

REF : PMOBP01



⊕ **Tournevis dynamométrique de 1 à 4 Nm (29 pièces)**

REF : PPP-GT0014



⊕ **Jeu de 8 tournevis isolés 1000V Contrôleur de tension type tournevis**

Plat : 2,5x85, 4x100, 5,5x125, 6,5x150 / Phillips : PH0x75, PH1x100, PH2x100

REF : PPP-GS-8100-8B

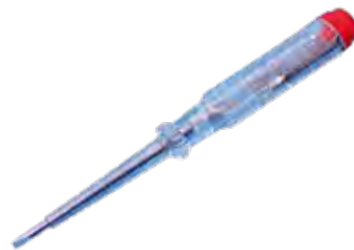

⊕ **Contrôleur de tension type tournevis**

REF : P-EL01



⊕ **Jeu de 7 tournevis isolés 1000V**

Plat : 2,5x85, 4x100, 5,5x125, 6,5x150 / Phillips : PH0x75, PH1x100, PH2x100

REF : PPP-GS-8100



⊕ **Tournevis à lames interchangeables**

1 plat : 4 mm - 6,5 mm

2 Phillips : PH0 - PH1 / PH2 - PH3

2 Pozidriv : PZ0 - PZ1 / PZ2 - PZ3

3 Etoile : T10 - T15 / T20 - T25 / T30 - T40

2 Hex (6 pans) : 3 mm - 4 mm / 5 mm - 6 mm

1 porte embout 6 pans

REF : TT-GAAI2101



⊕ **Jeu de 10 clés mâles 6 pans à tête sphérique**

1,5/2/2,5/3/4/5/6/7/8/10

REF : PPP-MBE10



⊕ **Jeu de 7 clés étoile**

T10/15/20/25/27/30/40

REF : TT-GAAL0705



⇒ Coffret 100 embouts

Plat, Phillips, Pozi, Etoile, Hex 6 pans... (pour visseuses ou tournevis porte-embout)
• REF : PPP-BS100



⇒ Clé coudée 8 mm (pour porte VAG)

REF : PPP-76808K



⇒ Cliquet chrome poli 1/4"

REF : TT-CHAG0813

⇒ Cliquet chrome poli 3/8"

REF : TT-CHAG1218

⇒ Cliquet chrome poli 1/2"

REF : TT-CHAG1626



⇒ Coffret 37 pièces Ø 10 Torx / Ribe / XZN / 6 pans

Embouts Etoile : T10, T15, T20, T25, T27, T30 T40, T45, T50, T55, T60, T70

Embouts Hex 6 pans : 4, 5, 6, 8, 10, 12

Embouts XZN :

M4, M5, M6, M8, M10, M12

Embouts Ribe :

M4, M5, M6, M7, M8, M9, M10, M12, M13, M14

Porte embout 1/2" x 10 mm /

Porte embout 3/8" x 10 mm

Rallonge porte embout 90 mm x 10 mm

(pour cliquet carré 1/2 et carré 3/8)

REF : PPP-BS37



⇒ Cliquet embout 1/4"

REF : PPP-BR14



⇒ Jeu de 40 embouts Etoile / 6 pans / XZN

Embouts Etoile :

30 mm x T20, T25, T30, T40, T45, T50, T55

75 mm x T20, T25, T30, T40, T45, T50, T55

Embouts Hex 6 pans :

30 mm x 4, 5, 6, 7, 8, 10, 12

75 mm x 4, 5, 6, 7, 8, 10, 12

Embouts XZN :

30 mm x M5, M6, M8, M10, M12

75 mm x M5, M6, M8, M10, M12

Porte embout 1/2" x 10 mm /

Porte embout 3/8" x 10 mm

(pour cliquet carré 1/2 et carré 3/8)

REF : TT-GAAD4002



⇒ Cliquet 1/4" court (45 dents)

REF : TT-CHD10809

⇒ Cliquet 3/8" court (45 dents)

REF : TT-CHD11211

⇒ Cliquet 1/2" court (45 dents)

REF : TT-CHD11613



⇒ Clé dynamométrique à cliquet 1/4" (6 nm - 30 nm)

REF : TT-ANAF0803

⇒ Clé dynamométrique à cliquet 3/8" (19 nm - 110 nm)

REF : TT-ANAF1211

⇒ Clé dynamométrique à cliquet 1/2" (40 nm-210 nm)

REF : TT-ANAF1621

⇒ Clé dynamométrique à cliquet 1/2" (70 nm - 350 nm)

REF : TT-ANAF1635



⇒ Doigt à cliquet 1/4"

REF : PPP-SCA14FR

⇒ Doigt à cliquet 3/8"

REF : PPP-SCA38FR



☉ Coffret cliquet 1/4" - 35 pièces - Chrome Vanadium poli

Cliquet 1/4" - Poignée emmanchée 150 mm 1/4" - Rallonge 100 mm 1/4" - Rallonge 150 mm 1/4" - Cardan universel 1/4" - Porte embouts 1/4" - Douilles 1/4" 6 pans : 4, 4.5, 5, 5.5, 6, 7, 8, 9, 10, 11, 12, 13, 14 mm - Embouts tournevis plat : 4, 4.5, 7 mm - Embouts tournevis pozidriv : 1, 2, 3 mm - Embouts tournevis Hex 6 pans : 3, 4, 5, 6 mm - Embouts tournevis étoile percée : T10, T15, T20, T25, T30, T40

REF : PPP-SCA14635MS



☉ Coffret cliquet 3/8" - 33 pièces - Chrome Vanadium poli

Cliquet 3/8" - Rallonge 75 mm 3/8" - Rallonge 150 mm 3/8" - Cardan universel 3/8" Douilles courtes 3/8" 6 pans : 6, 7, 8, 9, 10, 11, 12, 13, 14, 15, 16, 17, 18, 19 mm
Douilles longues 3/8" 6 pans : 6, 7, 8, 9, 10, 11, 12, 13, 14, 15, 16, 17, 19, 22 mm

REF : PPP-SCA38633MS



☉ Coffret douilles 1/2" - 25 pièces - Chrome Vanadium poli

Cliquet 1/2" - Rallonge 125 mm 1/2" - Rallonge 250 mm 1/2" - Poignée coulissante 250 mm 1/2" - Poignée articulée 360 mm 1/2" - Cardan universel 1/2" - Douilles courtes 1/2" 6 pans : 10, 11, 12, 13, 14, 15, 16, 17, 18, 19, 20, 21, 22, 24, 27, 30, 32 mm - Douille pour bougie 21 mm

REF : PPP-SCA12625MS



☉ Coffret cliquet 3/4" - 21 pièces

16 x Douilles 3/4" : 19,21,22,23,24,26,27,29,30,32,35,36,38,41,46,50 mm - 1 x Cliquet 3/4" poignée coulissante 3/4" 500-800 mm - 1 x Cardan universel 3/4" - 1 x Poignée articulée 3/4" 500-800 mm - 2 x Rallonges : 150 mm et 200 mm

REF : TT-GCAI2104



☉ Coffret cliquet 1" - 15 pièces

1 x Cliquet 1" - 1 x Barre de 550 mm - 1 x Tête pour poignée coulissante 79 mm - 2 x Rallonges : 200 et 400 mm - Douilles 6 pans : 36,41,46,50,55,60,65,70,75,80

REF : TT-GCAD1404



☉ Coffret cliquet débouché

Adaptateurs 1/2" & 3/8" + Rallonge 60 mm - Douilles 10,11,12,13,14,15,16,17,18,19 mm - Douilles 3/8", 7/16", 1/2", 9/16", 5/8", 11/16", 3/4"

REF : PPP-SCHZIMIS



⇒ Douille courte 6 pans - Chrome Vanadium - Douille 1/4" - 3/8" - 1/2"

	Douille 1/4"		Douille 3/8"		Douille 1/2"	
4 mm	PPP-SCS14604M	2,24 €				
4,5 mm	PPP-SCS146045M	2,24 €				
5 mm	PPP-SCS14605M	2,24 €				
5,5 mm	PPP-SCS146055M	2,24 €				
6 mm	PPP-SCS14606M	2,24 €	PPP-SCS38606M	2,39 €		
7 mm	PPP-SCS14607M	2,24 €	PPP-SCS38607M	2,39 €		
8 mm	PPP-SCS14608M	2,24 €	PPP-SCS38608M	2,39 €		
9 mm	PPP-SCS14609M	2,39 €	PPP-SCS38609M	2,39 €		
10 mm	PPP-SCS14610M	2,39 €	PPP-SCS38610M	2,39 €	PPP-SCS12610M	4,32 €
11 mm	PPP-SCS14611M	2,39 €	PPP-SCS38611M	2,39 €	PPP-SCS12611M	4,47 €
12 mm	PPP-SCS14612M	2,70 €	PPP-SCS38612M	2,39 €	PPP-SCS12612M	4,47 €
13 mm	PPP-SCS14613M	2,70 €	PPP-SCS38613M	2,39 €	PPP-SCS12613M	4,47 €
14 mm	PPP-SCS14614M	2,70 €	PPP-SCS38614M	2,39 €	PPP-SCS12614M	4,73 €
15 mm			PPP-SCS38615M	2,50 €	PPP-SCS12615M	4,73 €
16 mm			PPP-SCS38616M	2,81 €	PPP-SCS12616M	4,73 €
17 mm			PPP-SCS38617M	2,81 €	PPP-SCS12617M	4,73 €
18 mm			PPP-SCS38618M	2,81 €	PPP-SCS12618M	5,20 €
19 mm			PPP-SCS38619M	2,27 €	PPP-SCS12619M	5,20 €
20 mm					PPP-SCS12620M	5,20 €
21 mm					PPP-SCS12621M	5,20 €
22 mm					PPP-SCS12622M	5,20 €
23 mm						
24 mm					PPP-SCS12624M	5,20 €
27 mm					PPP-SCS12627M	5,20 €
30 mm					PPP-SCS12630M	5,93 €
32 mm					PPP-SCS12632M	5,93 €



⇒ Douille longue 6 pans - Chrome Vanadium - Douille 1/4" - 3/8" - 1/2"

	Douille 1/4"		Douille 3/8"		Douille 1/2"	
4 mm	PPP-SCD14604M	2,39 €				
4,5 mm						
5 mm	PPP-SCD14605M	2,39 €				
5,5 mm						
6 mm	PPP-SCD14606M	2,39 €	PPP-SCD38606M	4,89 €		
7 mm	PPP-SCD14607M	2,39 €	PPP-SCD38607M	4,89 €		
8 mm	PPP-SCD14608M	2,39 €	PPP-SCD38608M	5,10 €		
9 mm	PPP-SCD14609M	2,50 €	PPP-SCD38609M	5,10 €		
10 mm	PPP-SCD14610M	3,07 €	PPP-SCD38610M	5,10 €	PPP-SCD12610M	7,44 €
11 mm	PPP-SCD14611M	3,07 €	PPP-SCD38611M	5,10 €	PPP-SCD12611M	7,44 €
12 mm	PPP-SCD14612M	3,22 €	PPP-SCD38612M	5,10 €	PPP-SCD12612M	7,44 €
13 mm	PPP-SCD14613M	3,69 €	PPP-SCD38613M	5,67 €	PPP-SCD12613M	7,44 €
14 mm	PPP-SCD14614M	3,69 €	PPP-SCD38614M	5,82 €	PPP-SCD12614M	7,44 €
15 mm			PPP-SCD38615M	5,82 €	PPP-SCD12615M	8,94 €
16 mm			PPP-SCD38616M	5,82 €	PPP-SCD12616M	8,94 €
17 mm			PPP-SCD38617M	5,82 €	PPP-SCD12617M	8,94 €
18 mm			PPP-SCD38618M	7,12 €	PPP-SCD12618M	8,94 €
19 mm			PPP-SCD38619M	7,12 €	PPP-SCD12619M	8,94 €
20 mm			PPP-SCD38620M	7,12 €	PPP-SCD12620M	8,94 €
21 mm			PPP-SCD38621M	7,12 €	PPP-SCD12621M	10,40 €
22 mm			PPP-SCD38622M	7,12 €	PPP-SCD12622M	10,40 €
23 mm					PPP-SCD12623M	10,40 €
24 mm					PPP-SCD12624M	10,40 €
27 mm					PPP-SCD12627M	11,91 €
30 mm					PPP-SCD12630M	11,91 €
32 mm					PPP-SCD12632M	11,91 €



⇒ Douille tournevis étoile et tournevis étoile percée : douille étoile

Douille étoile		Douille étoile percée	
PPP-SC38T08	5,20 €	PPP-SC38T08H	5,20 €
PPP-SC38T10	5,93 €	PPP-SC38T10H	5,93 €
PPP-SC38T15	5,93 €	PPP-SC38T15H	5,93 €
PPP-SC38T20	5,93 €	PPP-SC38T20H	5,93 €
PPP-SC38T25	6,71 €	PPP-SC38T25H	6,71 €
PPP-SC38T27	6,71 €	PPP-SC38T27H	6,71 €
PPP-SC38T30	6,71 €	PPP-SC38T30H	6,71 €
PPP-SC38T40	6,71 €	PPP-SC38T40H	7,44 €
PPP-SC38T45	7,44 €	PPP-SC38T45H	7,44 €
PPP-SC38T50	8,94 €	PPP-SC38T50H	10,40 €
PPP-SC38T55	8,94 €	PPP-SC38T55H	10,40 €
PPP-SC38T60	8,94 €	PPP-SC38T60H	10,40 €



⇒ Jeu de 13 douilles 1/4" longues 6 pans
4, 4,5, 5, 5,5, 6, 7, 8, 9, 10, 11, 12, 13, 14 mm
REF : TT-GAAQ1309

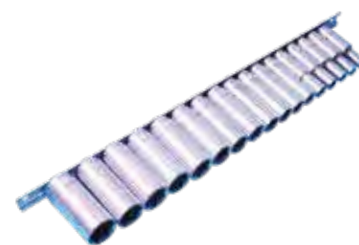

⇒ Jeu de 14 douilles longues 3/8" 6 pans
6,7,8,9,10,11,12,13,14,15,16,17,18,19 mm
REF : PPP-SCD38614S

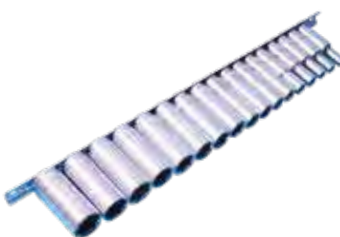

⇒ Jeu de 17 douilles longues 3/8" 6 pans
6,7,8,9,10,11,12,13,14,15,16,17,18,19,20,21,22 mm
REF : PPP-SCD38617S



⇒ Jeu de douilles à chocs renforcées
17/19/21 + protection téflon (spéciale jante aluminium)
REF : PZBWS12P3





⊕ Douille étoile courte 1/4" & 3/8"

Douille 1/4"		Douille 3/8"	
PPP-SC-14SE04	4,32 €	PPP-SC38SE04	5,93 €
PPP-SC-14SE05	4,32 €	PPP-SC38SE05	5,93 €
PPP-SC-14SE06	4,32 €	PPP-SC38SE06	5,93 €
PPP-SC-14SE07	4,32 €	PPP-SC38SE07	5,93 €
PPP-SC-14SE08	4,32 €	PPP-SC38SE08	5,93 €
PPP-SC-14SE10	4,32 €	PPP-SC38SE10	5,93 €
PPP-SC-14SE11	4,32 €	PPP-SC38SE11	5,93 €
		PPP-SC38SE12	5,93 €
		PPP-SC38SE14	5,10 €
		PPP-SC38SE16	5,10 €
		PPP-SC38SE18	5,77 €
		PPP-SC38SE20	5,77 €



⊕ Douille 3/8" 6 pans

Douille		Douille tête sphérique	
PPP-SC-38H03	4,99 €	PPP-SC-38HB03	6,21 €
PPP-SC-38H04	4,99 €	PPP-SC-38HB04	6,21 €
PPP-SC-38H05	5,93 €	PPP-SC-38HB05	6,21 €
PPP-SC-38H06	5,93 €	PPP-SC-38HB06	6,21 €
PPP-SC-38H08	6,21 €	PPP-SC-38HB08	6,45 €
PPP-SC-38H10	6,21 €	PPP-SC-38HB10	6,66 €

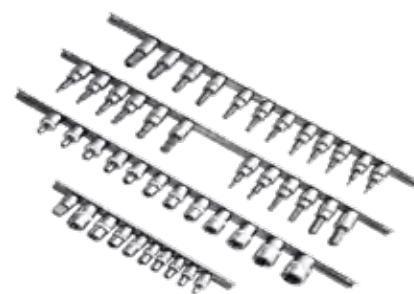

⊕ Jeu de 12 douilles 3/8" tournevis étoile (T8-T60)

REF : PPP-SC38T512S

⊕ Jeu de 12 douilles 3/8" tournevis étoile percée (T8-T60)

REF : PPP-SC-38TH12S

⊕ Jeu de 9 douilles 1/4" & 3/8" étoile (T8-T60)

1/4": E4-E11, 3/8": E12-E14 + adaptateur 1/4" à 3/8"

REF : PPP-SC-14/38SE9SA

⊕ Jeu de 12 douilles étoile 3/8" (E4-E20)

REF : PPP-SC-38SE12S

⊕ Jeu de 6 douilles 3/8" 6 pans

H03/H04/H05/H06/H08/H10

REF : PPP-SC-38H6S

⊕ Jeu de 6 douilles 3/8" 6 pans sphériques

H03/H04/H05/H06/H08/H10

REF : PPP-SC-38HB6S

⊕ Jeu de 12 embouts mâles 6 pans

REF : PPP-SC-38H-HB12S



⊕ Accessoires pour cliquet 1/4", 3/8" & 1/2"

PPP-SCA1404X	Rallonge 100mm	1/4"	3,12 €
PPP-SCA1406X	Rallonge 150mm	1/4"	8,32 €
PPP-SCA1406SH	Poignée emmanchée 150 mm	1/4"	13,36 €
PPP-SCA14UJ	Cardan universel	1/4"	10,40 €
PPP-SCA14BH	Porte embout	1/4"	6,71 €
PPP-SCA3803X	Rallonge 75mm	3/8"	4,32 €
PPP-SCA3806X	Rallonge 150mm	3/8"	5,04 €
PPP-SCA3810X	Rallonge 250mm	3/8"	7,12 €
PPP-SCA3812A	Augmentateur -	3/8" à 1/2"	5,36 €
PPP-SCA3814A	Réducteur	3/8" à 1/4"	5,36 €
PPP-SCA38UJ	Cardan universel	3/8"	7,12 €
PPP-SCA1205X	Rallonge 125mm	1/2"	6,19 €
PP-SCA1210X	Rallonge 250mm	1/2"	6,71 €
PPP-SCA12T	Poignée coulissante	1/2"	13,94 €
PPP-SCA12UJ	Cardan universel	1/2"	13,42 €
PPP-SCA1236KB	Poignée articulée	1/2"	13,42 €



⊕ Support 400 mm pour douilles 1/4"

REF : PPP-SCA14400R

⊕ Support 400 mm pour douilles 3/8"

REF : PPP-SCA38400R

⊕ Support 400 mm pour douilles 1/2"

REF : PPP-SCA12400R



⊕ Plateau support douilles 1/4", 3/8" & 1/2"

REF : PPP-SOCT



⊕ Jeu de 12 clés mixtes Chrome Vanadium

8, 9, 10, 11, 12, 13, 14, 15, 16, 17, 18, 19 mm

REF : PPP-CPK12M



⊕ Jeu de 16 clés mixtes Chrome Vanadium

8, 9, 10, 11, 12, 13, 14, 15, 16, 17, 18, 19, 20, 21, 22, 24 mm

REF : PPP-CPK16M





☞ Clé mixte - Chrome Vanadium

PPP-CP06M	6mm	4,00 €	PPP-CP20M	20mm	8,63 €
PPP-CP07M	7mm	4,00 €	PPP-CP21M	21mm	8,84 €
PPP-CP08M	8mm	4,26 €	PPP-CP22M	22mm	9,72 €
PPP-CP09M	9mm	4,26 €	PPP-CP23M	23mm	9,98 €
PPP-CP10M	10mm	4,26 €	PPP-CP24M	24mm	10,82 €
PPP-CP11M	11mm	4,21 €	PPP-CP25M	25mm	11,75 €
PPP-CP12M	12mm	4,52 €	PPP-CP26M	26mm	13,21 €
PPP-CP13M	13mm	4,99 €	PPP-CP27M	27mm	14,72 €
PPP-CP14M	14mm	4,99 €	PPP-CP28M	28mm	14,72 €
PPP-CP15M	15mm	5,72 €	PPP-CP29M	29mm	15,70 €
PPP-CP16M	16mm	5,98 €	PPP-CP30M	30mm	15,70 €
PPP-CP17M	17mm	7,12 €	PPP-CP32M	32mm	18,20 €
PPP-CP18M	18mm	7,44 €	PPP-CP34M	34mm	25,58 €
PPP-CP19M	19mm	7,85 €	PPP-CP36M	36mm	33,85 €

PPP-CP-1/4	1/4"	4,58 €	PPP-CP-7/8	7/8"	9,72 €
PPP-CP-5/16	5/16"	5,43 €	PPP-CP-15/16	15/16"	10,92 €
PPP-CP-3/8	3/8"	5,82 €	PPP-CP-1	1"	16,12 €
PPP-CP-7/16	7/16"	5,36 €	PPP-CP-1-1/16	1 + 1/16"	15,29 €
PPP-CP-1/2	1/2"	7,59 €	PPP-CP-1-1/8	1 + 1/8"	16,38 €
PPP-CP-9/16	9/16"	6,24 €	PPP-CP-1-1/4	1 + 1/4"	20,23 €
PPP-CP-5/8	5/8"	6,55 €	PPP-CP-1-3/16	1 + 3/16"	33,33 €
PPP-CP-11/16	11/16"	7,12 €	PPP-CP-1-3/8	1 + 3/8"	33,33 €
PPP-CP-3/4	3/4"	8,94 €	PPP-CP-1-7/16	1 + 7/16"	34,94 €
PPP-CP-13/16	13/16"	9,62 €	PPP-CP-1-1/2	1 + 1/2"	33,33 €

☞ Clé à pipe

6 mm • REF : PPP-CP06M-AW
 7 mm • REF : PPP-CP07M-AW
 8 mm • REF : PPP-CP08M-AW
 9 mm • REF : PPP-CP09M-AW
 10 mm • REF : PPP-CP10M-AW
 11 mm • REF : PPP-CP11M-AW
 12 mm • REF : PPP-CP12M-AW
 13 mm • REF : PPP-CP13M-AW
 14 mm • REF : PPP-CP14M-AW
 15 mm • REF : PPP-CP15M-AW
 16 mm • REF : PPP-CP16M-AW
 17 mm • REF : PPP-CP17M-AW
 18 mm • REF : PPP-CP18M-AW
 19 mm • REF : PPP-CP19M-AW
 20 mm • REF : PPP-CP20M-AW
 21 mm • REF : PPP-CP21M-AW
 22 mm • REF : PPP-CP22M-AW
 23 mm • REF : PPP-CP23M-AW
 24 mm • REF : PPP-CP24M-AW



☞ Jeu de 10 clés mixtes courtes Chrome Vanadium

10, 11, 12, 13, 14, 15, 16, 17, 18, 19 mm
 REF : PPP-CPK510M



☞ Jeu de 19 clés à pipe Chrome Vanadium

6, 7, 8, 9, 10, 11, 12, 13, 14, 15, 16, 17, 18, 19, 20, 21, 22, 23, 24 mm
 REF : PPP-CPAWK19MM



☞ Clé étoile

E6 x E8 • REF : PPP-CPE01
 E10 x E12 • REF : PPP-CPE02
 E11 x E12 • REF : PPP-CPE03
 E14 x E16 • REF : PPP-CPE04
 E14 x E18 • REF : PPP-CPE05
 E20 x E24 • REF : PPP-CPE06
 E22 x E24 • REF : PPP-CPE07



☞ Clé mixte courte Chrome Vanadium

10 mm • REF : PPP-CP510M
 11 mm • REF : PPP-CP511M
 12 mm • REF : PPP-CP512M
 13 mm • REF : PPP-CP513M
 14 mm • REF : PPP-CP514M
 15 mm • REF : PPP-CP515M
 16 mm • REF : PPP-CP516M
 17 mm • REF : PPP-CP517M
 18 mm • REF : PPP-CP518M
 19 mm • REF : PPP-CP519M



☞ Jeu de 12 clés mixtes à cliquet Ø 8 à 19 mm

REF : PPP-CPGR12K

☞ Clé mixte à cliquet réversible

8 mm • REF : PPP-CPGR08M
 9 mm • REF : PPP-CPGR09M
 10 mm • REF : PPP-CPGR10M
 11 mm • REF : PPP-CPGR11M
 12 mm • REF : PPP-CPGR12M
 13 mm • REF : PPP-CPGR13M
 14 mm • REF : PPP-CPGR14M
 15 mm • REF : PPP-CPGR15M
 16 mm • REF : PPP-CPGR16M
 17 mm • REF : PPP-CPGR17M
 18 mm • REF : PPP-CPGR18M
 19 mm • REF : PPP-CPGR19M



⊕ Clé à molette 200 mm
REF : TT-AMAB2920



⊕ Clé à molette 200 mm
REF : TT-AMAA2920
⊕ Clé à molette 255 mm
REF : TT-AMAA3325
⊕ Clé à molette 300 mm
REF : TT-AMAA3830



⊕ Pince universelle 203 mm
REF : TT-DBBB2208



⊕ Pince à bec 203 mm
REF : TT-DFBB2208



⊕ Pince coupante 150 mm
REF : TT-DEBB2206



⊕ Pince coupante diagonale 178 mm
REF : TT-DEBC2207



⊕ Pince multiprise 250 mm
REF : TT-DDBA2210



⊕ Jeu de 4 pinces circlips
Pince circlips extérieure 178 mm
Pince circlips extérieure coudée 178 mm
Pince circlips intérieure 178 mm
Pince circlips intérieure coudée 178 mm
REF : TT-GBA10401



⊕ Pince coupante diagonale 130 mm
REF : PPP-PL05W
⊕ Pince à bec 152 mm
REF : PPP-PL06LN
⊕ Pince universelle 178 mm
REF : PPP-PL07C

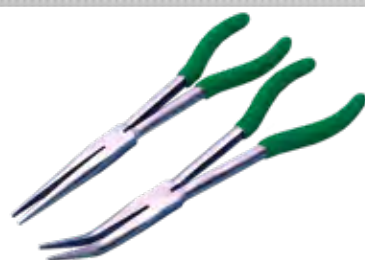

⊕ Pince à bec extra longue 280 mm
REF : TT-DFAG1211
⊕ Pince à bec extra longue 280 mm 45°
REF : TT-DFAH1211



⊕ Pince-étiau à bec long 150 mm
REF : PPP-GM6LNA
⊕ Pince-étiau à bec long 200 mm
REF : PPP-GM9LNA



⊕ Pince-étiau à bec courbé 125 mm
REF : PPP-GM05CCA
⊕ Pince-étiau à bec courbé 180 mm
REF : PPP-GM07CCA
⊕ Pince-étiau à bec courbé 250 mm
REF : PPP-GM10CCA



⇒ Pince-étau à bec droit 235 mm
REF : TT-DAARIA10



⇒ Clé à sangle caoutchouc 190 mm
REF : PPP-SWL
⇒ Clé à sangle caoutchouc 140 mm
REF : PPP-SWS
⇒ Jeu de 2 clés à sangle caoutchouc
REF : PPP-SW-SET



⇒ Cisaille universelle
REF : PPP-KN9505140



⇒ Pince multiprise cobra 250 mm
REF : PPP-KN8701250
⇒ Pince multiprise cobra 400 mm
REF : PPP-KN8701400
⇒ Pince multiprise cobra 560 mm
REF : PPP-KN8701560



⇒ Coupe boulon jusqu'à 3,6 mm
REF : PPP-KN7112200



⇒ Coupe câble jusqu'à 6 mm KNIPEX
REF : PPP-KN9561190



⇒ Jeu de 2 mini pinces KNIPEX
Cobra + pince clé
REF : PPP-KN00207251



⇒ Pince à rivet pop alu avec 4 embouts
REF : TT-JBAA2448



⇒ Pince à rivet tête orientable
Ø 2,4 / 3,2 / 3,9 / 4,9 mm
REF : TT-JBAC2448



⇒ Pince à rivet pop & écrous borgnes
Rivet pop jusqu'à Ø 6,4 mm - Ecrous borgnes (inserts)
Ø 4 / 5 / 6 / 8 / 10 mm
REF : PP-203



⊕ **Maillet en caoutchouc 450 g - Ø 60 mm**
REF : PPP-RM16



⊕ **Massette à embout adaptable**
REF : TT-HAAF3530



⊕ **Jeu de 5 limes demi-douce**

1 x 200 mm demi-douce plate
1 x 200 mm demi-douce demi ronde
1 x 200 mm demi-douce carrée
1 x 200 mm demi-douce triangulaire
1 x 200 mm demi-douce ronde
REF : PPP-EFSET5



⊕ **Marteau rivoir 35 mm**
REF : PPP-FRH35



⊕ **Marteau rivoir 40 mm**
REF : PPP-FRH40



⊕ **Marteau rivoir 55 mm 2kg**
REF : PPP-FRH55



⊕ **Marteau à garnir 225 g**
REF : PPP-6108



⊕ **Jeu de 6 mini limes 100 mm**

1 ronde / 1 triangulaire / 1 plate / 1/2 ronde / 1 carrée / 1 plate d'entrée
REF : PPP-EFSET6M



⊕ **Mètre à ruban 5 m**
REF : PPP-TM050



⊕ **Coffret 40 pièces Tarauts Filières**

1 tourne-à-gauche M3-M12 / 1 tourne-à-gauche T-Type M3-M6 (coulissante poignée en T)
1 porte filière : (1") de 25 mm de diamètre extérieur
1 Jeu de Jauge de 0,5 à 1,75 et 27, 28
Filières : M3x0.5, M3x0.6, M4x0.7, M4x0.75, M5x0.8, M5x0.9, M6x0.75, M6x1.0
Filières : M7x0.75, M7x1.0, M8x1.0, M8x1.25, M10x1.25, M10x1.5 & 1/8 NPT-27
Filières : M12x1.25, M12x1.5
Tarauts : M3x0.5, M3x0.6, M4x0.7, M4x0.75, M5x0.8, M5x0.9, M6x0.75, M6x1.0, M7x0.75, M7x1.0, M8x1.0, M8x1.25, M10x1.25, M10x1.5, M12x1.25, M12x1.5
REF : TT-JGA14001





⊕ Jeu de 16 pièces chasse goupille + burin

REF : PPP-GT0008



⊕ Jeu de 4 burins

9, 13, 18 et 24 mm

REF : PPP-GT0009



⊕ Burin plat 13 mm

REF : PPP-WC2



⊕ Chasse goupille Ø 2 mm

REF : PPP-WC28



⊕ Jeu de 5 chasses goupille

3, 4, 5, 6 et 8 mm

REF : PPP-GT0015



⊕ Jeu de 4 chasses goupille

10, 12, 14 et 16 mm

REF : PPP-GT0010



⊕ Pointeau automatique réglable de 15 à 25 kg

REF : PPP-GT0027



⊕ Jeu de 3 outils pour le réglage d'écartement et l'alignement des éléments de carrosserie

REF : PPP-BJ-PAK



⊕ Jeu de 7 outils pour garnitures

Utilisés pour la dépose délicate d'accessoires

REF : PPP-BJ7SET-LBN



⊕ Jeu de 9 outils pour garnitures

Résistant aux produits chimiques - Utilisés pour agrafer les surfaces délicates

REF : PPP-BJ9SET-DB



⊕ Jeu de 5 outils pour garnitures

Matière très résistante - Utilisés en mécanique pour agrafer les plans de joints

REF : PPP-BJ5SET-EE



⊕ Spatule rigide #08

Composition nylon/plastique dense

REF : PPP-BJ08DB





⊕ **Spatule plastique rigide #09**
Composition nylon/plastique dense
REF : PPP-BJ09DB



⊕ **Spatule plastique rigide #10**
Composition nylon/plastique dense
REF : PPP-BJ10DB



⊕ **Spatule plastique rigide #11**
Composition nylon/plastique dense
REF : PPP-BJ11DB



⊕ **Spatule plastique rigide #13**
Composition nylon/plastique dense
REF : PPP-BJ13DB



⊕ **Spatule plastique rigide #15**
Composition nylon/plastique dense
REF : PPP-BJ15DB



⊕ **Spatule plastique rigide #16**
Composition nylon/plastique dense
REF : PPP-BJ16DB



⊕ **Spatule plastique rigide #17**
Composition nylon/plastique dense
REF : PPP-BJ17DB



⊕ **Spatule plastique rigide #18**
Composition nylon/plastique dense
REF : PPP-BJ18DB



⊕ **Spatule plastique #01**
Composition nylon/plastique standard
REF : PPP-BJ01LB



⊕ **Spatule plastique #02**
Composition nylon/plastique standard
REF : PPP-BJ02LB



⊕ **Spatule plastique #03**
Composition nylon/plastique standard
REF : PPP-BJ03LB



⊕ **Spatule plastique #04**
Composition nylon/plastique standard
REF : PPP-BJ04LB



⊕ **Spatule plastique #05**
Composition nylon/plastique standard
REF : PPP-BJ05LB



⊕ **Spatule plastique #06**
Composition nylon/plastique standard
REF : PPP-BJ06LB



⊕ **Spatule plastique #07**
Composition nylon/plastique standard
REF : PPP-BJ07LB



⊕ **Spatule plastique extrême dureté #08**
REF : PPP-BJ08EE



⊕ **Spatule plastique extrême dureté #10**
REF : PPP-BJ10EE



⊕ **Spatule plastique extrême dureté #11**
REF : PPP-BJ11EE



⊕ **Spatule plastique extrême dureté #15**
REF : PPP-BJ15EE



⊕ **Spatule plastique extrême dureté #17**
REF : PPP-BJ17EE



Mécanique automobile

OUTILLAGE PNEUMATIQUE, CAISSE À OUTILS, ...





⊕ **Aspirateur eau et poussière 2400 W, 60 L, bi-moteur, cuve inox**
 Livré avec : panier, canne, suceur et brosse.
 Ø tuyau 38 mm
 REF : **PP-ASPI-IN**



⊕ **Aspirateur eau et poussière 1300 W, 12 L, cuve plastique**
 Livré avec : panier, canne, suceur et brosse.
 Ø tuyau 35 mm
 REF : **PP-ASPI-YP1300/12**



⊕ **Aspirateur eau et poussière 1500 W, 27 L, cuve plastique**
 Livré avec : panier, canne, suceur et brosse.
 Ø tuyau 35 mm
 REF : **PP-ASPI-YP15/27**



⊕ **Aspirateur portable 18 V**
 Vendu sans batterie ni chargeur. Fonctionne avec batterie 18V de 2,0 ah jusqu'à 9,0 ah.
 REF : **PPP-MIL493343601**



⊕ **Moteur pour aspirateur gris**
 Compatible PP-ASPI-IN • REF : **PP-ASPI-MOTBIPASS**
 ⊕ **Moteur pour aspirateur noir**
 Compatible PP-ASPI-YP1300/12 et PP-ASPI-YP15/27
 REF : **PP-ASPI-MOTASPI-1**



⊕ **Pièces de rechange pour aspirateur**
 Embout brosse Ø 38 mm • REF : **PP-ASPI-BROSSE-R**
 Tuyau à la coupe • REF : **PP-ASPI-TUY38**
 Embout suceur Ø 38 mm • REF : **PP-ASPI-SUC38**



⊕ **Enrouleur électrique 25 m**
 3 x 1,5 mm² - 230 Volts
 REF : **PS1522**



⊕ **Enrouleur électrique 15 m**
 3 x 1,5 mm² - 230 Volts
 REF : **PRCE15**



⊕ **Enrouleur air comprimé 15 m (10 bars max)**
 REF : **PRM15**



⊕ **Enrouleur eau**
 Tuyau de 15 m, Ø 21 mm (Ø 16 mm int.)
 REF : **PS18445**





⊕ Caisse à outils plastique (580 mm)
Avec 2 paniers et 1 boîte de rangement transparente
REF : PPP-TBP580-2-1



⊕ Bac rond aimanté 150 mm
REF : TT-JJAF1506



⊕ Bac rectangulaire aimanté (240 x 140 mm)
REF : TT-JJAF2414



⊕ Décapeur thermique
Position 1 : 1000 W 350°C - Position 2 : 2000 W 550°C
REF : PPP-DECAPHERM



⊕ Coffret repousse pistons de frein tourne à gauche
20 pièces
REF : PPP-BST510

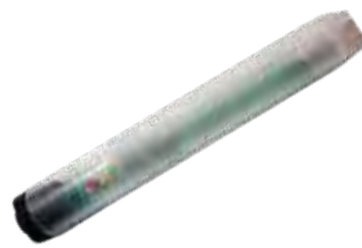

⊕ Testeur électrique de liquide de frein
REF : PPP-GT0002



⊕ Outil dépose biellette direction
REF : PZRET109



⊕ Extracteur de rotule
REF : PNS-YC-804



⊕ Vidangeur huile à pompe manuel 2,5 L
REF : PPP-AST280



⊕ Jeu de 5 clés polygonales coudées
13 / 15 / 16 / 17 / 19 - Pour démontage d'écrous difficiles d'accès
(poulies, tendeurs d'alternateurs...)
REF : PPP-AST270



⊕ Couteaux séparateurs Ø 30-50 mm
REF : PNS-YC-9000
⊕ Couteaux séparateurs Ø 50-75mm
REF : PNS-YF-9005



⊕ 4 outils à extraire les tiges filetées (caisse métal)
REF : PNS-YF1022
⊕ 4 outils à extraire les tiges filetées
(caisse plastique)
REF : PNS-YF1022A



⊕ Coffret de 10 extracteurs d'écrous
Ø 8-10-12-13-14-15-16-17-19-21
REF : PPP-GT0013B



⊕ Coffret de 5 extracteurs d'écrous
Ø 17-19-21-23-27
REF : PPP-GT0013



⊕ Pince pour fil de bougie
REF : PKT-17-K189



⊕ Outil pose bougie
REF : PKT-17-K122



⊕ Flexible pour pose de bougie (accès difficile)
REF : PKT-17-K154



⊕ Pince pour collier de durit
REF : PPP-AST203



⊕ Pince pour collier de transmission
REF : PNS-YF6301



⊕ Outil pose collier de joint de transmission
REF : PPP-AST202



⊕ Pince pour collier auto-serrant (embout en X)
REF : PNS-YF6014



⊕ Pince pour collier auto-serrant (embout en v)
REF : PNS-YF6014A



⊕ Pince pour collier auto-serrant (embout droit)
REF : PNS-YF6014D



⊕ Pince pour collier durit (type oreille)
REF : PNS-YF6303



⊕ Clé à filtre de 63 à 120 mm
REF : PP-AST201



⊕ Purgeur de frein et d'embrayage pneumatique
REF : PPP-BST800



⊕ Clé filtre PSA-RENAULT 3/8" 108 mm
REF : PPP-AST210



⊕ Coffret 20 bouchons de vidange + joints + tarauds
M/13/15/17/20
REF : PPP-AST250



⊕ Coffret restauration filetage
7 UNC, 7 UNF & 7 tarauds métriques
6 UNC, 6 UNF & 7 filières métriques
1 UNC, 1 UNF & 1 lime métrique
REF : PNS-YF1033



⊕ Jeu d'extracteurs
10 x guides de forets
5 x tiges d'extraction et écrous
5 x forets
REF : PNS-YF1037



⊕ Coffret de 3 outils à restaurer les filets + 2 jauges
#1 Métrique : 0,75/1,00/1,25/1,50/1,75/2,00/2,50/3,00 mm
#2 Impérial : 11, 12, 13, 14, 16, 18, 20 & 24 TPI
#3 Impérial : 9, 10, 12, 16, 20, 27, 28 & 32 TPI
1 jauge métrique - 1 jauge impérial
REF : PNS-YF1032K



⊕ Coffret de 6 extracteurs
3-6 mm, 6-8 mm, 8-11 mm, 11-14 mm, 14-18 mm, 18-25 mm
1/8"-1/4", 1/4"-5/16", 5/16"-7/16", 7/16"-9/16", 9/16"-3/4", 3/4"-1"
REF : PPP-GT0011



⊕ Outil pour compresser le ressort de soupape
Ouverture 55-175 mm - Profondeur 165 mm
REF : PNS-YF6235



⊕ Outil pour compresser le ressort de soupape
Ouverture 35-200 mm - Profondeur 250 mm
REF : PNS-YF6231



⊕ Outil pour montage / démontage silentbloc d'échappement
REF : PNS-YF6019



⊕ Compresseur de soupape pour moteur (arbre à cames en tête)
REF : PNS-YF6235



⊕ Pompe de transfert à levier pour fût
REF : PPP-TPB10



⊕ Pompe à graisse avec poignée pistolet 400 ml
REF : PPP-GG14PW



⊕ Pompe à graisse pneumatique avec poignée pistolet 400 ml
REF : PPP-GG14AW



⊕ Flexible 250 mm pour pompe à graisse
REF : PPP-GG-FFP-S
⊕ Flexible 400 mm pour pompe à graisse
REF : PPP-GG-FFP-L
⊕ Bec rigide coudé pour pompe à graisse
REF : PPP-GG-SFP

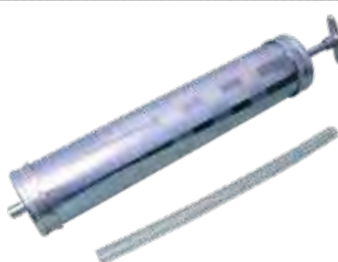

⊕ Seringue d'aspiration, tuyau flexible 300 mm
REF : PPP-GS18

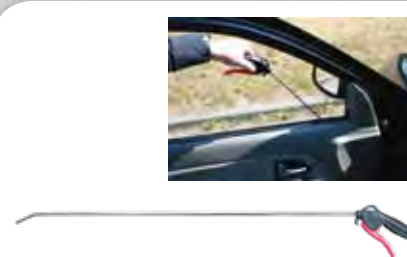

⊕ Soufflette longue 900 mm
Pour accéder aux endroits difficiles
REF : PS06342



⊕ Soufflette progressive
REF : TT-KAGA1904



⊕ Nettoyeur de gicleur de lave-glace
REF : PPP-332A



⊕ Doigt magnétique flexible 480 mm
Capacité 1,6 kg
REF : PPP-GT001Z



⊕ Doigt flexible et magnétique à griffes 600 mm
REF : PPP-MPF24



⊕ Rallonge magnétique 920 mm
Capacité 1 kg
REF : PPP-MPS36



⊕ **Démonte / remonte OBUS dynamométrique 45 Nm**
+/- 6 %
REF : PPP-GT0001



⊕ **Clé à chocs 1/2" composite**
1250 Nm - Très puissante - 2 Kg
REF : PPP-ROD2277



⊕ **Mini clé à chocs 1/2"**
610 Nm - Compacte et très puissante - 1,3 Kg
REF : PPP-RC202



⊕ **Clé à chocs 3/8"**
150 Nm - Très compacte - 1,1 Kg
REF : PPP-RC2100



⊕ **Clé à choc 1"**
2 900 Nm - Axe long - 8,1 Kg
REF : PPP-RC2477XI



⊕ **Clé à choc 3/4"**
1 950 Nm - Puissante et économique - 3,4 Kg
REF : PPP-RC2377



⊕ **Mini clé à rochet 1/4"**
30 Nm - Long : 140 mm - Tête extra plate 30 mm
REF : PPP-RC3001



⊕ **Clé à rochet 1/2"**
95 Nm - Très puissante
REF : PPP-RC3607



⊕ **Perceuse réversible**
10 mm - Mandrin auto serrant « Rohm »
REF : PPP-ROD-RC4500



⊕ **Perceuse réversible**
13 mm - Mandrin auto serrant « Rohm »
REF : PPP-ROD-RC4550



⊕ **Kit système de nettoyage MBX**
Enlève la rouille, la peinture, la colle et autres revêtements
REF : PPP-RC7091KITPFT



⊕ **Pince à rivets pneumatique**
Pour rivets de Ø 2,4 à Ø 5 mm - Alu et cuivre
REF : PPP-ROD6700



⊕ **Pince à rivets pneumatique**
Pour rivets de Ø 4,8 à Ø 6,4 mm - Bulbe & Bolt, alu, acier, inox
REF : PPP-ROD6720



⊕ **Scie sabre**
REF : PPP-ROD-RC6050



⊕ **Jeu de 5 lames de scies**
32 dents par lame
REF : PPP-RC8951011514
24 dents par lame
REF : PPP-RC8951011515



⊕ **Meuleuse droite**
26 000 tr/mm - Pince de 6 mm
REF : PPP-ROD7027



⊕ **Disqueuse**
REF : PPP-ROD7150



⊕ **Fer à souder sans variateur**
REF : PPP-KITREPLASTFEZ



⊕ **Baguettes de brasage (étui de 10)**
REF : PPP-KITREPLASTBAG



⊕ **Grille de renfort 18/8 250 x 125 mm (lot de 2)**
REF : PPP-KITREPLASTGRI



⊕ **Servante 3 plateaux**
Aluminium / plastique - 3 plateaux + bacs de rangements
- H 1105 mm x L 850 mm x P 500 mm
REF : PPP-L5075



⊕ **Servante Cantilever**
54,9 x 73,3 x 41,3
• REF : PSTAN-94210





⊕ Servante 7 tiroirs + 305 pièces

5 tiroirs aménagés : jeu de clés plates mixtes, jeu de clés coudées à œil, jeu de cliquets 1/4, jeu de cliquets 3/8, jeu de tournevis plats, jeu de tournevis Phillips, ...

REF : TT-GCAJ305N



⊕ Servante 7 tiroirs

7 grands tiroirs 580 x 405 mm (roulement à billes) 4 grandes roues 125 x 50 mm

REF : PS09214



⊕ Compresseur

Compresseur air 100 L - 2 cv / 8 bars - 14 m³/h

REF : PS11232



⊕ Embouts

Raccord mâle 1/4" Ø6 mm

REF : PPP-CP615 810 5620



⊕ Embouts

Raccord femelle 1/4" Ø6 mm

REF : PPP-CP615 810 5650



⊕ Embouts

Raccord rapide 1/4" femelle

REF : PPP-CP615 811 0750



⊕ Embouts

Raccord rapide 1/4" mâle

REF : PPP-CP615 811 0720



⊕ Marche pied aluminium

L : 700 mm x H : 500 mm x P : 300 mm

REF : PPP-ALPLATZ



⊕ Etou acier avec enclume

Base pivotante (ouverture 150 mm)

REF : PS15990



⊕ Touret à meuler

520 W - 150 mm - Brosse + meule grains 60 - 2 950 Tr/min

REF : PS15526





⊕ **Pistolet de nettoyage Tornador**

Nettoyage moquette, tableau de bord, garnitures de portes, de baie, de pavillon... - Pression de fonctionnement : 8 bars.
REF : **PPP-CN1**



⊕ **Produit de nettoyage pour Tornador**

5 litres - Produit concentré à diluer (exemple : 10 cl de produit concentré pour 1 L d'eau).
REF : **PPP-CN2**



⊕ **Absorbant Sepiolite 15 / 30**

Sac de 20 Kg • REF : **PS18550**



⊕ **Balai coco (manche à visser)**

290 mm x 55 mm
REF : **PS15965**



⊕ **Manche en bois brut à vis**

1 250 mm
REF : **PS15989**



⊕ **Balai coco (manche à pointer)**

1 000 mm x 55 mm - Ø28 mm
REF : **PS15984**



⊕ **Manche en bois**

Ø 24 mm
REF : **PS15985**

⊕ **Manche en bois**

Ø 28 mm
REF : **PS15987**



⊕ **Raclette métallique**

550 mm, Ø 24 mm
REF : **PS15925**





⊕ Réglophare

Pour réglage tout type de feux, y compris xénon et led / luxmètre numérique (réglage double laser)
REF : **PP-REGLO2**



⊕ Presse atelier

30 t - Livrée avec toutes les options
REF : **PPP-WP30P**



⊕ Vérin de fosse

600 Kg
REF : **PPP-GHN600**

⊕ Vérin de fosse

1 000 Kg
REF : **PPP-GHN1000**



⊕ Cric 1,5 tonne

Poids : 12 Kg - hauteur de levage : 82 mm - hauteur du crochet : 375 mm
REF : **PZBH1A1500**



⊕ Cric 2 tonnes

Hauteur de levage : 70 mm - hauteur du crochet : 490 mm - Pédale d'approche
REF : **PZBH12000**



⊕ Cric 3 tonnes

Hauteur de levage : 90 mm - hauteur du crochet : 552 mm - Pédale d'approche
REF : **PZBH13000**





Éclairage et électricité

BALADEUSES, CÂBLES, FUSIBLES...





➤ **Baladeuse Compress LEDS**
REF : PPP-LAMP15



➤ **Baladeuse 11 W - IP 55 - 220 V**
REF : PPP-LAMP5



➤ **Baladeuse 60 LEDS rechargeable**
REF : PPP-HL-LP60



➤ **Lampe Penlight 6 LEDS**
Fonctionne avec 2 piles • REF : PPP-LAMP13



➤ **Mini lampe de poche à LEDS**
Fonctionne avec 2 piles
REF : PPP-HL-P1



➤ **Rampe d'éclairage sous capot 30 W / 22 Volts**
REF : PPP-HL-FUBL



➤ **Lampe frontale LEDS**
REF : PPP-LAMP14



➤ **Sauvegarde mémoire véhicule 220 V**
REF : PPP-BEDMS20

➤ **Sauvegarde mémoire véhicule 12 V**
(utiliser une seconde batterie)
REF : PPP-BEDMS12



➤ **Sauvegarde mémoire 12 V**
Branchement prise OBD
REF : PEL14



➤ **Câbles de démarrage 600 Amp 2,5 m**
REF : PPP-ZZ-203



➤ **Câbles de démarrage 200 Amp 2,5 m**
REF : PPP-ZZ-202



➤ **Protecteur batterie 12 V**
REF : PPP-BEDSSCP12/24



⊕ **Fer à souder (Butane)**

REF : PPP-SIK-1



⊕ **Kit de 17 outils pour démonter les connectiques et terminaux des faisceaux**

Connectiques :
1,5 mm / 2,3 mm / 3,5 mm
Connectiques simples :
2,8 mm / 5,8 mm
Connectiques Micro-Timer II, III :
1,6 mm
Connectiques Ducon :
0,8 mm / 1,5 mm / 2,8 mm / 4,8 mm / 6,3 mm / 9,5 mm
Connectiques ABS :
1,6 mm
Connectiques doubles :
2,8 mm / 5,8 mm

REF : PEL11



⊕ **Pince à dénuder automatique pour cosses isolées et non isolées 1,5 - 6 mm²**

REF : PEL04



⊕ **Testeur de continuité**

Permet le test de polarité, continuité de 6 / 12 / 24 V - Remise à zéro automatique - Protection court circuit

REF : PEL10



⊕ **Pince à sertir automatique**

Sertissage cosses isolées - 0,5 - 1,0 mm², 1,5 - 2,5 mm², 4,0 - 6,0 mm²

REF : PEL05



⊕ **Testeur électrique 6 V, 12 V & 24 V**

REF : P-EL02



⊕ **Testeur électrique à pointe + Pique-fil (3-48V)**

REF : PEL03



⊕ **Multimètre**

DCV: 0-200m-2-20-200±0.5%-600V±0.8% ACV: 0-200V-600V±1.2%
DCA: 0-200u-2m-20m±1.0%-200mA±1.5% - 0A±3.0%
R: 0-200-2k-20k-200k±0.8%-20Mohm±1.0%

REF : PPP-MM-1



- ⊕ **Lampe à souder**
REF : PPP-WST60
- ⊕ **Pompe à dessouder**
REF : PPP-WST60B
- ⊕ **Fil à souder 250 g**
REF : PPP-WST60A



- ⊕ **Convertisseur**
12 V - 2 500 W - Charg 70 A
REF : PPP-CONCS+12-2500
- ⊕ **Convertisseur**
12 V - 3 600 W - Charg 70 A
REF : PPP-CONCS+12-3600



- ⊕ **Convertisseur**
12 V / 230 v - 1 200 W - 312 x 175 x 87 mm
REF : PPP-CONSW1200
- ⊕ **Convertisseur**
12 V / 230 v - 2 200 W - 312 x 175 x 87 mm
REF : PPP-CONSW2200



⊕ LES CONVERTISSEURS SONT DISPONIBLES SUR DEMANDE

**NOUS VOUS PROPOSERONS LE CONVERTISSEUR
QUI CORRESPOND A VOTRE UTILISATION.**



Carrosserie automobile

ÉQUIPEMENT ATELIER, ABRASIFS, ...





⊕ **Rouleau abrasif fibre • Longueur 10 m x largeur 1150 mm**
Pour dépolissage rapide du polyester, du gel-coat, du métal,
des sous-couches ou des laques

Rouleau fibre abrasive rouge (grain ± 360) • REF : **PP-MIRMIRL360**
 Rouleau fibre abrasive grise (grain ± 1500) • REF : **PP-MIRMIRL1500**
 Rouleau fibre abrasive kaki (grain ± 2000) • REF : **PP-MIRMIRL2000**



⊕ **Disque nylon abrasif Ø 150 mm**

Disque en fibre abrasive synthétique pour l'égrenage rapide, à sec ou à l'eau, du polyester, du gel-coat, du métal, des sous-couches ou des laques. Le rouge est plus particulièrement destiné à la préparation des surfaces et à l'égrenage des pièces neuves. Le gris est destiné à la préparation des zones de raccord, il se fixe sur un plateau velcro Ø 150 mm.

Le paquet de 10 disques nylon abrasif rouges (grain ± 360) • REF : **PP-MIRMIRL360-D**
 Le paquet de 10 disques nylon abrasif gris (grain ± 1500) • REF : **PP-MIRMIRL1500-D**



⊕ **Tampon abrasif avec fibres recouvertes 152 mm x 229 mm**

Fibre synthétique abrasive pour le dépolissage rapide du polyester, du gel-coat, du métal, des sous-couches ou des laques.

Boîte de 25 tampons abrasifs rouges (grain ± 360) • REF : **PP-MIRMIRL360-C**
 Boîte de 25 tampons abrasifs gris (grain ± 1500) • REF : **PP-MIRMIRL1500-C**
 Boîte de 25 tampons abrasifs marron (grain ± 2500) • REF : **PP-MIRMIRL2500-C**



⊕ **Abrasif sur mousse haute qualité (dévidoir de 25 m x 115 mm de large)**

Garniture mousse prédécoupée pour le ponçage à sec des mastics de finition, apprêt, pour le polissage des fonds avant peinture, se conforme parfaitement aux arêtes et aux courbes arrondies, tout en limitant le risque de perçage involontaire. En plus d'un confort d'utilisation, ce produit garantit une finition manuelle irréprochable.

P150 • REF : **PPP-ABM150**
 P240 • REF : **PPP-ABM240**
 P320 • REF : **PPP-ABM320**
 P400 • REF : **PPP-ABM400**
 P500 • REF : **PPP-ABM500**
 P600 • REF : **PPP-ABM600**



⊕ **Abrasif Ø 150 mm • 15 trous**

Abrasif standard de haute performance. Grain oxyde d'aluminium. Le choix des 15 trous permet une meilleure efficacité de « l'anti-encrassement » tout en conservant une surface de ponçage supérieure à un 9 trous. Cette perforation originale offre également une ventilation du disque plus homogène et crée moins d'échauffement de la surface.

50 disques auto-agrippants P60 • REF : **PP-MIRGOLD60**
 100 disques auto-agrippants P80 • REF : **PP-MIRGOLD80**
 100 disques auto-agrippants P120 • REF : **PP-MIRGOLD120**
 100 disques auto-agrippants P150 • REF : **PP-MIRGOLD150**
 100 disques auto-agrippants P220 • REF : **PP-MIRGOLD220**
 100 disques auto-agrippants P240 • REF : **PP-MIRGOLD240**
 100 disques auto-agrippants P320 • REF : **PP-MIRGOLD320**
 100 disques auto-agrippants P400 • REF : **PP-MIRGOLD400**
 100 disques auto-agrippants P500 • REF : **PP-MIRGOLD500**
 100 disques auto-agrippants P600 • REF : **PP-MIRGOLD600**
 100 disques auto-agrippants P800 • REF : **PP-MIRGOLD800**





Télécommande électrique et pneumatique



Double filtration



Filter polyester conique Antistatique conique

Cuve basculante



☉ Centrale d'aspiration 2 400 W • Avec décolmatage !

Hygiène, sécurité et performance pour un travail propre et sans poussière. Cette centrale mobile d'aspiration est un outil complet avec support de tuyau et plateau de grande dimension pour les accessoires et abrasifs.

Moteur : 2 - Tension : 230 V • Puissance : 2 400 W • Débit d'air : 360 m³/h • Dépression : 2 200 mm
Niveau sonore : 72 dB(A) • Capacité cuve : 72 l • Long. de câble : 8 m • Largeur : 510 mm
Hauteur : 1 040 mm • Longueur tuyau : 5,30 m • Cordon alimentation : 8 m
Livré avec 1 ponceuse et un flexible coaxial

REF : PPP-GPSA529 PNPX



☉ Ponceuse orbitale électrique ø 150 mm

Très ergonomique, moteur sans charbon, frein moteur et frein plateau, simple et intuitive, démarrage progressif.

Vitesse de rotation : de 4 000 tr/min à 10 000 tr/min • Poids : 1 kg • Niveau sonore : 71 dB(A)
Excentration : 5 mm

REF : PP-MIRPONCEDEROS



Télécommande électrique et pneumatique

☉ Centrale d'aspiration 1 500 W • Avec décolmatage !

Centrale d'aspiration conçue pour une ponceuse. De faible encombrement, elle est facile à transporter même à l'intérieur d'un espace réduit.

Moteur : 1 • Tension : 230 V • Puissance : 1 500 W • Débit d'air : 255 m³/h
Dépression : 2 230 mm • Niveau sonore : 75 dB(A) • Capacité cuve : 37 l
Longueur tuyau : 5,30 m • Cordon alimentation : 8 m
Livré avec 1 ponceuse et un flexible coaxial

REF : PPP-GPSA318 PNP



☉ Ponceuse orbitale pneumatique ø 150 mm

Vitesse de rotation : 12 000 tr/min • Excentration : 5 mm • Aspiration : centralisée
Consommation d'air : 485 l/min • Niveau sonore : 74,08 dB(A) • Vibration : 3,2 m/s²
Poids : 0,88 kg • Pression de service : 6,2 bars • Puissance : 270 W

REF : PP-MIRPONCE





⊕ Lustreuse MIRKA PS1437

Elle dispose d'un puissant moteur électrique à couple élevé, permettant d'atteindre la vitesse précise et nécessaire au polissage. La PS1437 peut aussi être utilisée en ponçeuse pour un enlèvement de matière rapide et efficace pour le décapage du bois et du métal • 230 V
REF : PP-MIRLUSTREUSE



⊕ Lustrant POLARSHINE 10

Cette pâte de lustrage Polarshine est idéale pour un travail de finition, s'utilise pour la carrosserie automobile (grain fin P1500) et aussi pour les applications bois • 1 L
REF : PP-MIRPOLAR



⊕ Kit cale aspirante

Support auto-agrippant, livré avec 5 tampons Abranet 70 x 198 mm
REF : PP-MIRCALE



⊕ Peau de mouton laine torsadée

Idéale pour le lustrage de finition et le poli-lustré • ø 150 mm
REF : PP-MIRPEAUMOUT





⊕ **Support peinture pivotant**
6 bras et pinces + 1 support pistolet (inclus une rallonge 700 mm)
REF : PPP-CM10



⊕ **Fraiseuse / Dépointeuse**
REF : PPP-RC6453



⊕ **Kit réparation plastiques par brasage**
Permet de réparer plus de 80% des plastiques
REF : PPP-KITREPLASTIC2



⊕ **Agrafeuse à chaud**
Livrée avec 300 agrafes sécables
REF : PPP-C16/1

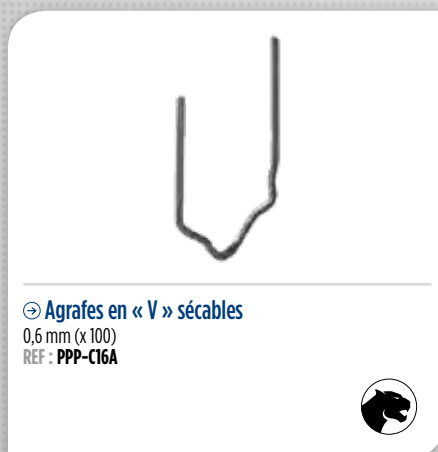

⊕ **Agrafes en « V » sécables**
0,6 mm (x 100)
REF : PPP-C16A

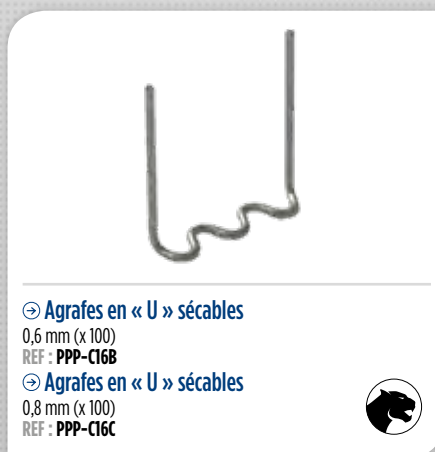

⊕ **Agrafes en « U » sécables**
0,6 mm (x 100)
REF : PPP-C16B
⊕ **Agrafes en « U » sécables**
0,8 mm (x 100)
REF : PPP-C16C



⊕ **D'AUTRES AGRAFES DISPONIBLES SUR DEMANDE**

FORMES DIFFÉRENTES, CASSABLES...



☉ Cales de retraitage étoile

Par 50 • REF : PPP-CS2



☉ Positionneur magnétique

REF : PPP-CS1



☉ Crochet 4 griffes

REF : PPP-CS43



☉ Crochet 10 griffes

REF : PPP-CS13



☉ Fil ondulé

Par 50 • REF : PPP-CS4



☉ Bande transfert d'adhésif

Pour emblèmes et logos. Maintenir la bande, la colle se dépose uniquement sur les points de contact utiles
REF : PPP-WST62TRANS



☉ Ruban de masquage grande qualité

Vendu à l'unité - Utilisable jusqu'à des températures de 80° en continu, résiste à l'eau et aux solvants. Retrait sans traces

REF : PCD-RM25 • 25 mm x 50 m

REF : PCD-RM36 • 36 mm x 50 m

REF : PCD-RM50 • 50 mm x 50 m





Consommables & Sécurité

CLIPS, LAVE-GLACE, HOUSSES, GANTS...





➔ Gaine thermorétractable

P-CS-HS821-1.2-1	2:1 Ø 1.2 mm (1m)	0,78 €
P-CS-HS821-1.2-10	2:1 Ø 1.2 mm (10m)	3,64 €
P-CS-HS821-1.6-1	2:1 Ø 1.6 mm (1m)	0,78 €
P-CS-HS821-1.6-10	2:1 Ø 1.6 mm (10m)	3,64 €
P-CS-HS821-12.7-1	2:1 Ø 12.7 mm (1m)	1,92 €
P-CS-HS821-12.7-10	2:1 Ø 12.7 mm (10m)	12,48 €
P-CS-HS821-19-1	2:1 Ø 19 mm (1m)	2,81 €
P-CS-HS821-19-10	2:1 Ø 19 mm (10m)	20,70 €
P-CS-HS821-2.4-1	2:1 Ø 2.4 mm (1m)	1,46 €
P-CS-HS821-2.4-10	2:1 Ø 2.4 mm (10m)	5,10 €
P-CS-HS821-3.2-1	2:1 Ø 3.2 mm (1m)	1,61 €
P-CS-HS821-3.2-10	2:1 Ø 3.2 mm (10m)	7,18 €
P-CS-HS821-4.8-1	2:1 Ø 4.8 mm (1m)	1,66 €
P-CS-HS821-4.8-10	2:1 Ø 4.8 mm (10m)	7,27 €
P-CS-HS821-6.4-1	2:1 Ø 6.4 mm (1m)	1,77 €
P-CS-HS821-6.4-10	2:1 Ø 6.4 mm (10m)	7,28 €
P-CS-HS821-9.5-1	2:1 Ø 9.5 mm (1m)	2,05 €
P-CS-HS821-9.5-10	2:1 Ø 9.5 mm (10m)	7,64 €
P-CS-HS831-3-1	3:1 Ø 3 mm (1m)	2,18 €
P-CS-HS831-3-10	3:1 Ø 3 mm (10m)	12,17 €
P-CS-HS831-4.5-1	3:1 Ø 4.5 mm (1m)	3,69 €
P-CS-HS831-4.5-10	3:1 Ø 4.5 mm (10m)	13,00 €
P-CS-HS831-6-1	3:1 Ø 6 mm (1m)	2,81 €
P-CS-HS831-6-10	3:1 Ø 6 mm (10m)	15,50 €



➔ Collier nylon

PPP-CN-N-100X2.5	100mm x 2.5mm (100)	0,75 €
PPP-CN-N-100X2.5-M	100mm x 2.5mm (1000)	5,15 €
PPP-CN-N-140X3.6	140mm x 3.6mm (100)	0,99 €
PPP-CN-N-140X3.6-M	140mm x 3.6mm (1000)	9,88 €
PPP-CN-N-160X2.5	160mm x 2.5mm (100)	1,23 €
PPP-CN-N-160X2.5-M	160mm x 2.5mm (1000)	12,27 €
PPP-CN-N-200X2.5	200mm x 2.5mm (100)	1,39 €
PPP-CN-N-200X2.5-M	200mm x 2.5mm (1000)	13,94 €
PPP-CN-N-200X3.6	200mm x 3.6mm (100)	1,72 €
PPP-CN-N-200X3.6-M	200mm x 3.6mm (1000)	17,16 €
PPP-CN-N-200X4.8	200mm x 4.8mm (100)	3,64 €
PPP-CN-N-200X4.8-M	200mm x 4.8mm (1000)	36,40 €
PPP-CN-N-300X3.6	300mm x 3.6mm (100)	4,06 €
PPP-CN-N-300X3.6-M	300mm x 3.6mm (1000)	40,56 €
PPP-CN-N-300X4.8	300mm x 4.8mm (100)	4,26 €
PPP-CN-N-300X4.8-M	300mm x 4.8mm (1000)	42,64 €
PPP-CN-N-370X4.8	370mm x 4.8mm (100)	4,47 €
PPP-CN-N-370X4.8-M	370mm x 4.8mm (1000)	44,72 €
PPP-CN-N-430X4.8	430mm x 4.8mm (100)	4,78 €
PPP-CN-N-430X4.8-M	430mm x 4.8mm (1000)	47,84 €



➔ Assortiment de 160 gaines thermorétractables de plusieurs couleurs

REF : PPP-A03000



➔ Jeu de 240 capuchons et passe cables caoutchouc

REF : P-CS-GMW-B-240



➔ Jeu de 120 passe cables

Ø trou x Ø passages cable) 6,4 x 4,0 / 7,9 x 5,5 / 9,5 x 8,0 / 11,0 x 8,0 / 14,3 x 11,0 / 17,5 x 12,5 / 19,0 x 12,5 mm

REF : P-CS-GMW-120A



➔ Jeu de 120 capuchons

Ø 8 - 9,5 - 12,5 - 15,5 - 19 - 22,5 - 25,4 mm

REF : P-CS-GMB-120A

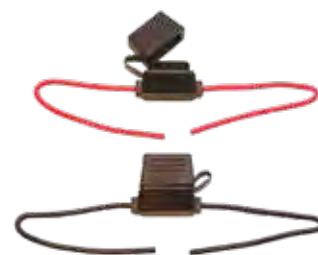

➔ Porte fusible enfichable 20 Amp résistant à l'eau

Câble noir • REF : P-CS-AFH-20SP

Câble rouge • REF : P-CS-AFH-20SP-1

Jeu de 10 - Câble noir • REF : P-CS-AFH-20SP-1X10

Jeu de 10 - Câble rouge • REF : P-CS-AFH-20SPX10



➔ Assortiment de 80 fusibles

2 / 3 / 4 / 5 / 7,5 / 10 / 15 / 20 / 25 / 30
REF : PPP-A02220



➔ Assortiment de 100 mini fusibles

2 / 3 / 4 / 5 / 7,5 / 10 / 15 / 20 / 25 / 30
REF : PPP-A02240



➔ Assortiment de 365 cosses

REF : PPP-1050



⊕ 25 jonctions thermorétractables rouges

REF : PPP-B13740

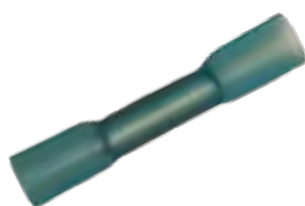

⊕ 25 jonctions thermorétractables bleues

REF : PPP-B13760



⊕ 10 jonctions thermorétractables jaunes

REF : PPP-B13780



⊕ 10x Clips de fixation

HD8r x HL3r x L 12mm - Auto perçant noir
REF : P-F-0001-10



⊕ 10x Clips de fixation

HD12.5r x HL6r x L 20 mm Auto perçant noir
REF : P-F-0002-10



⊕ 10x Clips de fixation

HD14r x HL8r x L 17 mm Type canoé noir
REF : P-F-0003-10



⊕ 10x Clips de fixation

HD14r x HL8r x L 18 mm - Type VW noir
REF : P-F-0004-10



⊕ 10x Clips de fixation

HD18r x HL8r x L 17 mm Type FORD noir
REF : P-F-0005-10



⊕ 10x Clips de fixation

HD18r x HL8r x L 17 mm Type FORD gris
REF : P-F-0006-10



⊕ 10x Clips de fixation

HD19r x HL10r x L 28 mm - Type VW noir
REF : P-F-0007-10



⊕ 10x Clips de fixation

HD25r x HL6r x L 16 mm Type AUDI noir
REF : P-F-0008-10



⊕ 10x Clips de fixation

HD13s x HL4r x L 9 mm Type VW noir
REF : P-F-0009-10

Légendes : r = Ronde - s = Carrée - o = Ovale HD = Tête - HL = Trou - L = Longueur



⊕ 10x Clips de fixation
HD17s x HL4r x L 5 mm Type VW noir
REF : P-F-0010-10



⊕ 10x Clips de fixation
HD16r x HL6r x L 15 mm Type arbre noir
REF : P-F-0011-10



⊕ 10x Clips de fixation
HD18r x HL6r x L 28 mm Type arbre noir
REF : P-F-0012-10



⊕ 10x Clips de fixation
HD24r x HL6r x L 18 mm Type arbre noir
REF : P-F-0013-10



⊕ 10x Clips de fixation
HD17r x HL6r x L 15 mm Type multi marches noir
REF : P-F-0014-10



⊕ 10x Clip de fixation
HD18r x HL8r x L 11 mm Type FORD blanc
REF : P-F-0015-10



⊕ 10x Clips de fixation
HD20r x HL8r x L 12 mm Type FORD/VW gris
REF : P-F-0016-10



⊕ 10x Clips de fixation
HD13r x HL8r x L 14 mm Type FORD/VW/BMW noir
REF : P-F-0017-10



⊕ 10x Clips de fixation
HD13r x HL8r x L 12 mm Type FORD bleu
REF : P-F-0018-10



⊕ 10x Clips de fixation
HD18r x HL8r x L 14 mm Type VW/AUDI noir
REF : P-F-0019-10



⊕ 10x Clips de fixation
HD17r x HL8r x L 14 mm Type VW/AUDI transparent
REF : P-F-0020-10



⊕ 10x Clips de fixation
HD33r x HL8r x L 9 mm Type VW/AUDI blanc
REF : P-F-0021-10

Légendes : r = Ronde - s = Carrée - o = Ovale HD = Tête - HL = Trou - L = Longueur



⊕ **10x Clips de fixation**
HD29r x HL8r x L 11 mm Type VW/AUDI marron/blanc
REF : **P-F-0022-10**



⊕ **10x Clips de fixation**
HD22r x HL9r x L 9 mm Type VW/AUDI noir
REF : **P-F-0023-10**



⊕ **10x Clips de fixation**
HD18s x HL4r x L 5 mm Type VW blanc
REF : **P-F-0024-10**



⊕ **10x Clips de fixation**
HD18s x HL4r x L 5 mm Type VW blanc
REF : **P-F-0025-10**



⊕ **10x Clips de fixation**
HD18r x HL8r x L 10 mm Type VW blanc / gris
REF : **P-F-0026-10**



⊕ **10x Clips de fixation**
HD10s x HL4r x L 4 mm Clip twist noir
REF : **P-F-0027-10**



⊕ **10x agrafes**
Agrafes baguettes BMW 5 et 7 (E32+E34)
REF : **PPP-AG1**



⊕ **10x agrafes**
Agrafes inférieures de PB MINI (2000+)
REF : **PPP-AG2**



⊕ **10x agrafes**
Agrafes inférieures de PB MINI (2000+)
REF : **PPP-AG3**



⊕ **10x agrafes**
Agrafes inférieures de PB XSARA (97+)
REF : **PPP-AG4**



⊕ **10x agrafes**
Agrafes latérales de PB C2 (2003+)
REF : **PPP-AG5**



⊕ **10x agrafes**
Agrafes latérales de PB C4 Picasso (2006+)
REF : **PPP-AG6**

Légendes : r = Ronde - s = Carrée - o = Ovale HD = Tête - HL = Trou - L = Longueur



⊕ 10x agrafes
Agrafes latérales de PB C5 (2008+)
REF : **PPP-AG7**



⊕ 10x agrafes
Agrafes latérales blanches de PB FORD TRANSIT (2000+)
REF : **PPP-AG8**



⊕ 10x agrafes
Agrafes latérales noires de PB FORD TRANSIT (2000+)
REF : **PPP-AG9**



⊕ 10x agrafes
Agrafes blanches de PB VITO (1996+)
REF : **PPP-AG10**



⊕ 10x agrafes
Agrafes de PB PEUGEOT 206/BOXER
REF : **PPP-AG11**



⊕ 10x agrafes
Rivets PB PEUGEOT 206 (1998+)
REF : **PPP-AG12**



⊕ 10x agrafes
Agrafes latérales de PB PEUGEOT 407 (2004+)
REF : **PPP-AG13**



⊕ 10x agrafes
Agrafes latérales de PB PEUGEOT 407
REF : **PPP-AG14**



⊕ 10x agrafes
Agrafes larérales de PB PEUGEOT 407
REF : **PPP-AG15**



⊕ 10x agrafes
Agrafes latérales de PB PEUGEOT 308 CC et Berline
REF : **PPP-AG17**



⊕ 10x agrafes
Agrafes latérales de PB PEUGEOT 308/508
REF : **PPP-AG18**



⊕ 10x agrafes
Agrafes latérales de PB CLIO 3 (2005+)
REF : **PPP-AG19**

Légendes : r = Ronde - s = Carrée - o = Ovale HD = Tête - HL = Trou - L = Longueur



⊕ **10x agrafes**
Agrafes de PB SEAT IBIZA (1999+)
REF : **PPP-AG20**



⊕ **10x agrafes**
Agrafes latérales de PB SEAT LEON (2005+)
REF : **PPP-AG21**



⊕ **10x agrafes**
Agrafes de PB GOLF 3
REF : **PPP-AG22**



⊕ **10x agrafes**
Agrafes inférieures de PB GOLF 3
REF : **PPP-AG23**



⊕ **10x agrafes**
Agrafes coin inférieur de PB GOLF 3
REF : **PPP-AG24**



⊕ **Jeu d'agrafes**
Coffret de 230 agrafes
REF : **PPP-AGN**



⊕ **Jeu de 220 rivets plastique divers (aveugles/ clips)**
REF : **P-F-PDR-220**



⊕ **Jeu de 120 rivets plastique type vis et rivets aveugles/clips**
REF : **P-F-STR.120**



⊕ **Jeu de 220 capuchons en plastique pour garnitures**
REF : **P-F-PTB-220**



⊕ **Jeu de 105 clips garniture Ford**
Inclus : attaches pression, rivets plastique, embouts
REF : **P-F-FTF-105**



⊕ **Jeu de 130 clips garniture GM**
Inclus : rivets clips, vis, bagues de blocage, rivets
REF : **P-F-GMTF-130**



⊕ **Vis auto-perçantes plates Pozo**
4 mm x 12 mm (x200) • REF : **P-CS-S-PZF-N-4X12**
6 mm x 12 mm (x200) • REF : **P-CS-S-PZF-N-6X12**
4 mm x 18 mm (x200) • REF : **P-CS-S-PZF-N-4X18**

Légendes : r = Ronde - s = Carrée - o = Ovale HD = Tête - HL = Trou - L = Longueur



Assortiment de 140 rivets pop

4,8 mm x 10 mm / 4,0 mm x 10 mm / 4,0 mm x 14 mm / 3,2 mm x 8 mm / 3,2 mm x 12 mm / 4,8 mm x 10 mm / 6,4 mm x 12 mm
REF : P-CS-RVK-1-140

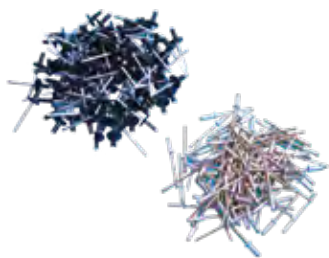

Rivets pop noirs 4,0 mm x 10 mm (x100)

REF : PPP-0864PR

Rivets pop 3,2 mm x 10 mm (x100)

REF : PPP-8000PR



Rivet pop 4 x 16 éclaté blanc (x 500)

Pour plaque d'immatriculation - Pour d'autres dimensions, nous consulter
REF : PPP-FAR5514016S0363



Rivet pop noir éclaté 4 x 16 x 8 (x 500)

Pour plaque d'immatriculation - Pour d'autres dimensions, nous consulter
REF : PPP-FAR55140164



Rivet éclaté 4,8 x 16 x 14TL noir (x 250)

Pour d'autres dimensions, nous consulter
REF : PPP-FAR5514816S004



Rivet pop alu 6,4 x 22 x 12 (x 500)

Pour d'autres dimensions, nous consulter
REF : PPP-FAR502642203



Jeu de 19 forets HSS

1 - 1,5 - 2 - 2,5 - 3 - 3,5 - 4 - 4,5 - 5 - 5,5 - 6 - 6,5 - 7 - 7,5 - 8 - 8,5 - 9 - 9,5 - 10 mm

REF : PPP-FO19HSS

PP-FMHSS2	HSS 2 mm	0,78 €
PP-FMHSS2.5	HSS 2,5 mm	1,23 €
PP-FMHSS3	HSS 3 mm	0,88 €
PP-FMHSS3.5	HSS 3,5 mm	1,78 €
PP-FMHSS4	HSS 4 mm	2,29 €
PP-FMHSS4.5	HSS 4,5 mm	2,08 €
PP-FMHSS5	HSS 5 mm	2,29 €
PP-FMHSS5.5	HSS 5,5 mm	2,60 €
PP-FMHSS6	HSS 6 mm	3,48 €
PP-FMHSS7	HSS 7 mm	3,02 €
PP-FMHSS7.5	HSS 7,5 mm	4,84 €
PP-FMHSS8	HSS 8 mm	4,84 €
PP-FMHSS8.5	HSS 8,5 mm	5,72 €
PP-FMHSS9	HSS 9,5 mm	5,72 €
PP-FMHSS10	HSS 10 mm	5,72 €
PP-FMHSS11	HSS 11 mm	5,72 €
PP-FMHSS12	HSS 12 mm	6,03 €
PP-FMHSS13	HSS 13 mm	7,18 €
PP-FMHSS4.2D	HSS 4,2 mm Double affûtage	2,29 €



Foret à dépointer

RMXD EXTRA DURE 3200 WIKERS 8 mm
REF : PPP-C8

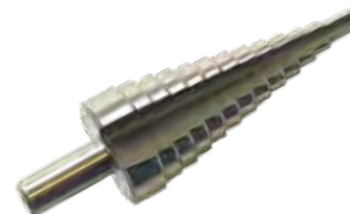

Foret conique étagé de 6 à 30 mm

REF : PS13524



Foret 4,2 double affûtage

Pour plaque d'immatriculation
REF : PP-FMHSS4.2D



Fraise carbure sphérique boule

Ø 10 x 9 mm - Queue Ø : 6 x 53 mm
REF : PPP-C4



⊕ **Disque à tronçonner INOX 75 x 1,0 x 10 mm**
Vendu à l'unité • REF : **PPP-RH206803**
⊕ **Disque à tronçonner INOX 230 x 2,5 x 22,2 mm**
Vendu à l'unité • REF : **PPP-RH206373**



⊕ **Disque à lamelles 80 • 115 x 22,2 mm**
Vendu à l'unité • REF : **PPP-RH202680**



⊕ **Disque à tronçonner METAUX 125 x 0,8 x 22,2 mm**
Vendu à l'unité • REF : **PPP-RH206684**
⊕ **Disque à tronçonner METAUX 125 x 1,5 x 22,2 mm**
Vendu à l'unité • REF : **PPP-RH207439**



⊕ **Brosse métallique torsadée Ø 75 mm sur tige**
REF : **PPP-C3**



⊕ **Gomme de décapage**
REF : **PPP-C2**

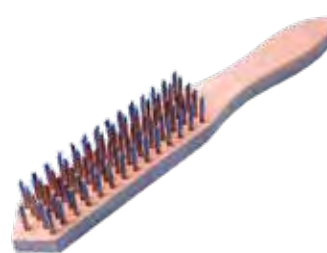

⊕ **Brosse métallique**
REF : **PPP-WST13**



⊕ **Lames disque plate Ø 63 mm Fein**
Boite de 2
REF : **PPP-WST450**
⊕ **Lames disque plate Ø 80 mm Fein**
Boite de 2
REF : **PPP-WST45P**



⊕ **Brosse de décapage « GROSSIER » acier 23 mm**
REF : **PPP-C40**



⊕ **Brosse de décapage « FINE » acier 23 mm**
REF : **PPP-C41**



⊕ **Scie-cloche**
Ø : 67 mm • REF : **PPKW74-1067**



⊕ **Scie-cloche**
Ø : 85 mm • REF : **PPKW-85**



⊕ **Nettoyant frein**
500 ml • REF : PPP-8501

(2,54 € par 6)



⊕ **Nettoyant électrique**
500 ml • REF : PPP-8502

(4,10 € par 6)



⊕ **Graisse blanche au teflon**
500 ml • REF : PPP-8503

(4,73 € par 6)



⊕ **Graisse cuivre**
500 ml • REF : PPP-8504

(4,94 € par 6)



⊕ **Nettoyant pour vitres**
500 ml • REF : PPP-8505

(4,14 € par 6)



⊕ **Huile pénétrante graphitée (dégrissant)**
500 ml • REF : PPP-8506

(3,53 € par 6)



⊕ **Graisse transparente**
500 ml • REF : PPP-8507

(4,57 € par 6)



⊕ **Nettoyant pour carburateur**
500 ml • REF : PPP-8508

(4,14 € par 6)



⊕ **Spray lubrifiant multifonction**
500 ml • REF : PPP-8509

(3,38 € par 6)



⊕ **Spray silicone**
500 ml • REF : PPP-8510

(4,68 € par 6)



⊕ **Lubrifiant de chaîne**
500 ml • REF : PPP-8511

(5,20 € par 6)



⊕ **Cire corps creux**
500 ml • REF : PPP-8512





⊕ **Eponges jumbo**
REF : PRLAV0039



⊕ **Eponges « Magique » paquet de 10 en mélamine**
REF : PRLAV0040



⊕ **Lingettes microfibre (x 4)**
REF : PRLAV0041



⊕ **Peau chamoisée**
REF : PRLAV0042



⊕ **Shampooing auto**
50 pastilles = 250 litres (1 pastille = 5 litres)
(existe en sachet de 450 g pour 60 litres)
REF : PRLAV0035



⊕ Colle cyanoacrylate viscosité fluide 20 g
REF : P11000



⊕ Loctite 3090 - Adhésif instantané bicomposant en gel • Pour plastique, caoutchouc, métal, bois, papier, cuir
REF : P110006
⊕ Buses pour Loctite 3090
Sachet de 10
REF : P110006/B



⊕ Colle
REF : PRC00020



⊕ Adhésif verre/métal 6 ml + 50 ml LOCTITE 317
REF : P11004
⊕ Adhésif verre/métal 24 ml + 165 ml LOCTITE 317
REF : P11004.1



⊕ Adhésif isolant 19 mm x 20 m
REF : PPP-101



⊕ Ruban auto vulcanisant 25 mm x 10 m
REF : PPP-105



⊕ Adhésif orange 50 mm x 33 m - Pré découpé tous les 15 cm
Utilisé pour faire les lissages entre la baie et le vitrage. Maintient des vitrages pendant le séchage. Ne laisse pas de résidu de colle.
REF : PPP-WST62O



⊕ Adhésif gris toilé 50 mm x 50 m
REF : PPP-WST62CT
⊕ Adhésif noir toilé 50 mm x 50 m
REF : PPP-WST62CT/NOIR



⊕ Double face 6 mm x 10 m • REF : PPP-WST62B
⊕ Double face 9 mm x 10 m • REF : PPP-WST62A1
⊕ Double face 12 mm x 10 m • REF : PPP-WST62C
⊕ Double face 19 mm x 10 m • REF : PPP-WST62I



⊕ Double face transparent 19 mm x 50 m - 0,5 mm
REF : PPP-WST62I-T05
⊕ Double face transparent 19 mm x 10 m - 1 mm
Adhésif forte adhérence
REF : PPP-WST62I-T1



⊕ Adhésif gris repositionnable pré-découpé tous les 30 cm
38 mm x 33 m - Extrêmement résistant
REF : PPP-WST62CT/M



⊕ **Bidon lave vitre 10L**
REF : PPP-WST70-LV10N



⊕ **Dosette lave-glace**
Boîte distributrice de 50 dosettes de 10 g
(1 dosette = 5 litres de lave-glace)
REF : PRLAV0051



⊕ **Poudre Lave-glace**
450 g = 208 litres de lave-glace
REF : PRLAV0030



⊕ **Dose antigel**
Permet de transformer votre lave-glace été en hiver (jusqu'à -10°C pour une dose et -16°C pour deux doses)
REF : PRLAV0045



⊕ **80 lingettes professionnelles**
Spécial nettoyage difficile (polyuréthane, primaire, graisse,...)
REF : PPP-WST0BRY
Vendues également par 6 : prix unitaire



⊕ **80 lingettes Vulcanet**
REF : PPP-WSTVULCA
Vendues également par 6 : prix unitaire



⊕ **72 lingettes essuie-mains**
Spéciales peinture et colle pare-brise
REF : PPP-WST0WYP



⊕ **Savon à main**
Spécial peinture et colle pare-brise - 3 kg
REF : PPP-WST70



⊕ **Savon à main spécial polyuréthane 500 ml**
REF : PPP-WST0F3M



⊕ **72 lingettes essuie-mains SCRUBS**
Spéciales peinture et colle pare-brise
REF : PPP-WST0SCRUBS
Vendues également par 6 : prix unitaire



⊕ **Rouleaux d'essuie-mains (x 2)**
REF : PPP-PAP-1000
Vendus par 40 rouleaux :



⊕ **Chiffon de nettoyage non pelucheux**
Efficace avec les solvants, les détergents et les désinfectants.
Certifié contact alimentaire. 500 feuilles. H : 276 mm.
Poids : 3,4 kg
REF : PPP-TORK3



↳ Essuie-glaces DURA VISION Classic

Une gamme complète de balais classiques
REF : DV40 à DV65



↳ Essuie-glaces DURA VISION Flex

Une gamme complète de balais plats adaptables à tous types de véhicules
REF : DVF35 à DVF70



↳ Présentoir DURA VISION



↳ Essuie-glaces arrière DURA VISION

Une gamme complète de balais d'essuie-glace arrière
REF : DVR30 à DVR40



↳ Chiffon de nettoyage

Efficace avec les solvants, les détergents et les désinfectants. Certifié contact alimentaire. 200 feuilles (30 x 16,5 cm). H : 165 mm. Poids : 673 g. Longueur de rouleau : 60 m
REF : PPP-TORK1
Existe une recharge • REF : PPP-TORK2



↳ Chiffon de nettoyage ultra résistant

Multi-usage. Bonne absorption des huiles et eaux. Certifié contact alimentaire. 200 feuilles (42 x 38 cm). H : 245 mm. Poids : 2,637 kg
REF : PPP-TORK4



↳ Chiffon de nettoyage non pelucheux

Efficace avec les solvants, les détergents et les désinfectants. Certifié contact alimentaire. 200 feuilles (38 x 27 cm). Poids : 480 g
REF : PPP-TORK5



⊕ Gilet haute visibilité large
REF : PZ-HVV



⊕ Triangle de signalisation
REF : PZ-WT



⊕ Lunettes de sécurité transparentes ergonomiques
REF : P10029A
⊕ Lunettes de sécurité teintées ergonomiques
REF : P10029A-1



⊕ Lunettes de sécurité
REF : P10029



⊕ Lunettes de sécurité anti-buée
REF : P10029B



⊕ Lunettes de sécurité type masque
REF : PNS-NP154



⊕ Gants en cuir (doker)
REF : PPP-GL01
⊕ Gants en cuir renforcé (doker)
REF : PPP-GL02



⊕ Gants Kevlar haute résistance aux coupures M (T8)
REF : PPP-GL12M
⊕ Gants Kevlar haute résistance aux coupures L (T9)
REF : PPP-GL12L
⊕ Gants Kevlar haute résistance aux coupures XL (T10)
REF : PPP-GL12XL



⊕ Gants de protection L (T9)
REF : PPP-GL15L
⊕ Gants de protection XL (T10)
REF : PPP-GL15XL



⊕ Gants tricot Kevlar taille unique
REF : PPP-GL10



⊕ Gants anti glisse
REF : PPP-GL03L



⊕ Gants de déménagement
REF : PPP-GL04



⊕ Sous-gants en coton taille unique
REF : PPP-GL07



⊕ Gants très souples, tricot / polyuréthane M (T8)
REF : PPP-GL557
⊕ Gants très souples, tricot / polyuréthane L (T9)
REF : PPP-GL557L
⊕ Gants très souples, tricot / polyuréthane XL (T10)
REF : PPP-GL557XL



⊕ Gants nitrile, boîte de 100 - M (T8)
REF : PPP-GL08NM
⊕ Gants nitrile, boîte de 100 - L (T9)
REF : PPP-GL08NL
⊕ Gants nitrile, boîte de 100 - XL (T10)
REF : PPP-GL08NXL



⊕ Gants en latex, boîte de 100 - L (T9)
REF : PPP-GL08
⊕ Gants en latex sans poudre, boîte de 100 - (T9)
REF : PPP-GL08PF
⊕ Gants en latex sans poudre, boîte de 100 - XL
REF : PPP-GL08PF-XL



⊕ Gants mécanicien avec paume renforcée - M (T8)
REF : PPP-GLKM15M
⊕ Gants mécanicien avec paume renforcée - L (T9)
REF : PPP-GLKM15L
⊕ Gants mécanicien avec paume renforcée - XL (T10)
REF : PPP-GLKM15XL



⊕ Gants mécanicien (fermetures scratch) - L (T9)
REF : PPP-GL13L



⊕ Sangle à pince 5 m
REF : PNS-STR05B



⊕ Sangle boucle simple plastique 5 m
REF : PNS-STR05BP



⊕ Sangle à cliquet 5 m avec attaches
REF : PNS-STR05H



⊕ Sangle à cliquet 7 m
REF : PNS-STR07R
⊕ Sangle à cliquet 10 m
REF : PNS-STR10R



⊕ Housse de protection intérieure 2 sièges
REF : PPP-WST66



⊕ Housse de protection intérieure 1 siège
REF : PPP-WST66S



⊕ **Housse pour volant**
REF : PPP-WST66V



⊕ **Couverture de capot**
REF : PPP-WST66C



⊕ **Protège capot anti glisse (non aimanté)**
1160 x 500 mm
REF : PPP-WST66GM



⊕ **Protège aile anti glisse (non aimanté)**
820 x 440 mm
REF : PPP-WST66WM



⊕ **Protection de pavillon (mousse)**
1150 x 650 mm
REF : PPP-WST6T



⊕ **Mousse de visite (genoux) 210 x 450 mm**
REF : PPP-MKM
⊕ **Mousse de visite 375 x 980 mm**
REF : PPP-MLM



⊕ **Rouleau de 250 housses de siège jetables**
13 μ • REF : PPP-WST66H250



⊕ **Tapis de sol papier**
70 g / m² - 38 x 50 cm - Rouleau de 250
REF : PPP-WST66T250



⊕ **Support mural de housse**
REF : PPP-WST66D



⊕ **Cagoule de soudage à cristaux liquides**
Base pivotante (ouverture 150 mm) - 2 capteurs
REF : PS0575Z



⊕ **Trousse à pharmacie**
Pour 4 à 6 personnes
REF : PS1716S



⊕ Piles High Energy - Alcaline

1,5 V - LR03 AAA (par 4) • REF : PPP-VARLR03AAA
 1,5 V - LR6 AA (par 4) • REF : PPP-VARLR6AA
 1,5 V - 4,5 V - 3LR12 • REF : PPP-VAR3LR12
 1,5 V - LR14 C (par 4) • REF : PPP-VARLR14C
 1,5 V - LR20 D (par 2) • REF : PPP-VARLR20D
 9 V - LR6 6I • REF : PPP-VAR6LR6I



⊕ Piles - Lithium 3V

CR 2016 - vendue à l'unité • REF : PPP-VARCR2016
 CR 2025 - vendue à l'unité • REF : PPP-VARCR2025
 CR 2032 - vendue à l'unité • REF : PPP-VARCR2032
 CR1/3N - vendue à l'unité • REF : PPP-VARCR1/3N
 CR 1216 - vendue à l'unité • REF : PPP-VARCR1216
 CR 1220 - vendue à l'unité • REF : PPP-VARCR1220
 CR 1225 - vendue à l'unité • REF : PPP-VARCR1225
 CR 2320 - vendue à l'unité • REF : PPP-VARCR2320
 CR 2430 - vendue à l'unité • REF : PPP-VARCR2430
 CR 2450 - vendue à l'unité • REF : PPP-VARCR2450
 CR 1616 - vendue à l'unité • REF : PPP-VARCR1616
 CR 1620 - vendue à l'unité • REF : PPP-VARCR1620
 CR 1632 - vendue à l'unité • REF : PPP-VARCR1632







Batteries automobile

	Référence produit	AH	CCA en Ampère	Polarité	Type de borne	Dimensions L x l x H	Poids en kg	Prix public HT
MAGIC TAB								
	PPP-TABM66H	66	640	0	DIN	242x175x190	15	150,00 €
	PPP-TABM100H	100	920	0	DIN	353x175x190	22,4	195,75 €
POLAR TAB								
	PPP-TABP45	45	400	0	DIN	175X175X190	10,7	96,25 €
	PPP-TABS45	45	420	0	DIN	207X175X175	10,7	86,90 €
	PPP-TABS50HF	50	450	0	DIN	207X175X190	12	90,50 €
	PPP-TABS60H	60	600	0	DIN	242X175X190	13,9	110,50 €
	PPP-TABS70H	60	600	0	DIN	278X175X190	16,2	132,90 €
	PPP-TABS95J	95	850	0	DIN	303X173X218	20,6	190,00 €
	PPP-TABS95JX	95	850	1	DIN	303X173X218	20,6	205,90 €
MAGIC TRUCK								
	PPP-TABTM17	170	1050	3	DIN	513X223X223	45	330,50 €
	PPP-TABTM12	225	1300	3	DIN	518X276X242	59,9	449,55 €
POLAR TRUCK								
	PPP-TABTR13A	135	850	3	DIN	513X189X218	34,5	245,55 €
NUMAX								
	PPP-NUM049H	45	300	0	DIN	219X135X225	9,9	119,95 €
	PPP-NUM100	70	640	0	DIN	278X175X175	15,5	135,90 €
	PPP-NUM096	70	640	0	DIN	278X175X190	16,2	135,50 €



Batteries



	Référence produit	Type de bac	AH	CCA en Ampère	Polarité	Type de borne	Dimensions L x l x H	Poids en kg	Prix public HT
VARTA SILVER DYNAMIC									
	PPP-VARD15	L2	63	610	0	DIN	242x175x190	15,3	137,91 €
	PPP-VARH3	L5	100	830	0	DIN	353x175x190	25,2	216,91 €
VARTA BLUE DYNAMIC									
	PPP-VARB36	L0	44	420	0	DIN	175x175x190	10,8	94,03 €
	PPP-VARB18	LB1	44	440	0	DIN	207x175x175	11,5	95,29 €
	PPP-VARC22	L1	52	470	0	DIN	207x175x190	12,7	115,34 €
	PPP-VARD24	L2	60	540	0	DIN	242x175x190	14,6	126,63 €
	PPP-VARE11	L3	74	680	0	DIN	278x175x190	17,3	156,72 €
	PPP-VARF17	LB4	80	740	0	DIN	315x175x175	18,8	168,01 €
	PPP-VARG3	L5	95	800	0	DIN	353x175x190	21,9	191,11 €
	PPP-VARG7	M11	95	830	0	DIN	306x173x225	21,7	191,11 €
PPP-VARG8	M11	95	830	1	DIN	306x173x225	21,7	191,11 €	
VARTA BLACK DYNAMIC 12V									
	PPP-VARB24	E2	45	300	1	DIN	219x135x225	10,08	94,03 €
	PPP-VARE9	LB3	70	640	0	DIN	278x175x175	16,4	144,17 €
	PPP-VARE13	L3	70	640	0	DIN	278x175x190	16,9	144,17 €
VARTA PRO MOTIVE SILVER									
	PPP-VARM18	B	180	1000	3	DIN	513x223x223	46,4	352,99 €
	PPP-VARN9	C	225	1000	3	DIN	518x276x242	58,1	450,37 €
VARTA PRO MOTIVE BLUE									
	PPP-VARK8	A	140	800	3	DIN	513x189x223	37,4	276,31 €



A RETOURNER PAR FAX AU 04 37 25 08 86 OU PAR MAIL À : contact@panther-pro.fr

Références	Qtité
------------	-------

COLLAGE

VITRAGE

PP-CO01	
PP-CO02	
PP-CO03	
PP-CO04	
PP-CO06	
PP-PUDOW2	
PP-PUDOW1	
PP-PRDOW	
PP-PRDOW2	
PP-DOWCLEAN2	
PP-PUSK3	
PP-PUSK1	
PP-PUSK	
PP-PUAC	
PP-PUAC2	
PP-PUPR7-1	
PP-PUPR7-2	
PP-PULV25	
PP-DEG1000	
PPP-WST54A	
PPP-WST54	
PPP-WST54W	

RETROVISEURS

P11004	
PP-SIKA5211NT	

PISTOLETS

PPP-MIL400/18V	
PPP-MIL310/18V	
PP-PTCCG7.22B	
PNS-WT-250L	
PP-AT-400CG	
PPP-MIL400/P3	
PNS-BG-ELR	
PPP-MIL400/TT	

DÉCOUPE

LAMES

PPP-WST451-A	
PPP-WST45L	
PPP-WST45I	
PPP-WST45ID	
PPP-WST45T	
PPP-WST45K	
PPP-WST45V19	
PPP-WST45X	
PPP-WST45F	
PPP-WST45G	
PPP-WST45D	
PPB-WK1S	
PPB-WK2S	
PPB-WK4ZS	
PPB-WK5S	
PPB-WK4ZRS	
PPB-WK27M	

Références	Qtité
------------	-------

PPB-WK28M	
PPB-WK27L	
PPB-WK28L	
PPB-WK10HD	
PPP-WST31B	
PPP-WST31C	
PPP-WST31D	
PPP-WST31CT	
PPP-WST31DT	
PPP-WST31BTTC	
PPP-WST31CTTC	
PPP-WST31DTTC	
PPP-WST31CD	
PPP-WST31DD	
PPP-WST31CR	
PPP-WST31Z	
PPP-WST31A	

CORDES A PIANO & OUTILS

PPP-WST27C	
PPP-WST27CP	
PPP-WST27D	
PPP-WST27DS	
PPP-WST27DS1B	
PPP-WST27K1	
PPP-WST27	
PPP-WST19TH	

CUTTERS / LAMES

POL-XL2	
POL-NOL1	
POL-SVR-01	
PPP-1404B	
PPP-1404BA	
PPP-1403B	
PPP-WST80	
PPP-WST80PN	
PPP-WST80-12	
PPP-WST80-16	
PPP-WST80-20	
PPP-RB1A	
PPP-WST80S	
PPP-RB3	
PPP-RB4	

DÉPOSE

VENTOUSES

PPP-WST40N	
PPP-WST391	
PPP-WST38P10	
PPP-WST631	

OUTILS VITRAGE

PPP-WST21	
PPP-WST05	
PPP-WST22	
PPP-WST73	
PPP-WST07	
PPP-WST07A	

Références	Qtité
------------	-------

PPP-WST17	
PPP-WST11	
PPP-WST64	
PPP-WST41N	
PPP-WST15AN	
PPP-WST14	
PPP-GT0006	

EXTRACTEURS

PPP-WST51A	
PPP-WST51B	
PPP-WST51C	
PPP-WST51P	

POSE

GELS / PASTILLES / CAPTEURS DE PLUIE

PPP-WST61KIT2	
PPP-WST61SIL1	
PPP-WST61SIL2	
PPP-WST61SIL3	
PPP-WST61SIL4	
PPP-WST61SIL5	
PPP-WST61SIL6	
PPP-WST61SIL7	
PPP-WST61SIL8	
PPP-WST61SIL9	
PPP-WST61A	
PPP-WST61B	
PPP-WST61D	
PPP-WST61E	
PPP-WST61F	
PPP-WST61H	
PPP-WST61G	
PPP-WST61J	
PPP-WST61I	
PPP-WST61M	
PPP-WST61L	

JOINTS

PPP-JT099	
PPP-JT006	
PPP-JT033	
PPP-JT044	
PPP-JT055	
PPP-JT111	
PPP-JT022	
PPP-JT066	
PPP-JT077	
PPP-JT088	

AGRAFES

PPP-AG1	
PPP-AG2	
PPP-AG3	
PPP-AG4	
PPP-AG5	
PPP-AG6	
PPP-AG7	
PPP-AG8	

Références	Qtité
------------	-------

PPP-AG9	
PPP-AG10	
PPP-AG11	
PPP-AG12	
PPP-AG13	
PPP-AG14	
PPP-AG15	
PPP-AG17	
PPP-AG18	
PPP-AG19	
PPP-AG20	
PPP-AG21	
PPP-AG22	
PPP-AGN	

RÉPARATION

RÉPARATION IMPACTS

P20013LN	
P20015N	
P10013LN	
P10015N	
P30013LN	
P30015LN	
P10018	
P10018B	
PPD-882140	
PPA-SBX2016	
PPA-HOS2010	
PPA-FIX2007	
P10027B	
PPD-840600	

RESTAURATION OPTIQUES POLYCARBONATE

PCD-1	
PCD-2	
PCD-3	
PCD-4	
PCD-5	
PCD-6	
PCD-C13	
PPP-POLIPHARE	

Références	Qtité
------------	-------

PROTECTION

PPP-WST66F	
PPP-WST49P	
PPP-WST49C	
PPP-WST49R2A	
PPP-WST66T250	
PPP-WST66H250	
PPP-GL557	
PPP-GL557L	
PPP-GL557XL	
PPP-GL08NL	
PPP-GL08NXL	

CONSOMMABLES

PPP-WST74	
PPP-WST74CT	
P11000	
PPP-WST62O	
PPP-WST62CT	
PPP-WST62CT/NOIR	
PPP-WST621-T1	
PPP-WST62B	
PPP-WST62A1	
PPP-WST62C	
PPP-WST621	
PPP-WST61	
PPP-WST70	
PPP-WST70WYP	
PPP-WST70SCRUBS	
PPP-WST70-LV10N	
PRDVIV0078	
PPP-8505	
PPP-8510	
PPP-8509	
PPP-8512	
PPP-WST61C	
DV40 à DV65	
DVF33 à DVF70	

VOTRE CACHET



Retrouvez encore plus de produits
et de vidéos sur le site
www.panther-pro.fr

Créez vous-même
votre compte en ligne
avec votre adresse mail



PANTHER PRO OUTILLAGE

1645 avenue Georges Guignard
47550 Boé

TEL: 02 54 82 32 95

FAX: 04 37 25 08 86

Courriel : contact@panther-pro.fr

www.panther-pro.fr